

Middle Power Class-D Speaker Amplifiers

Class-D Speaker Amplifier for Digital Input



BD5451EFV

No.11075EAT17

●Description

BD5451EFV is a Class D Speaker Amplifier designed for Flat-panel TVs in particular for space-saving and low-power consumption, delivers an output power of 15W+15W. This IC employs state-of-the-art Bipolar, CMOS, and DMOS (BCD) process technology that eliminates turn-on resistance in the output power stage and internal loss due to line resistances up to an ultimate level. With this technology, the IC can achieve high efficiency of 90% (15W+15W output with 8Ω load). In addition, the IC is packaged in a compact reverse heat radiation type power package to achieve low power consumption and low heat generation and eliminates necessity of external heat-sink up to a total output power of 30W. This product satisfies both needs for drastic downsizing, low-profile structures and many function, high quality playback of sound system.

●Features

- 1) This IC has one system of digital audio interface.
(I²S format, SDATA: 16 / 20 / 24bit, LRCLK: 32kHz / 44.1kHz / 48kHz, BCLK: 64fs(fixed), MCLK: 256fs(fixed))
- 2) Low supply current at RESET mode.
- 3) The decrease in sound quality because of the change of the power supply voltage is prevented with the feedback circuitry of the output. In addition, a low noise and low distortion are achieved.
Eliminate large electrolytic-capacitors for high performance of Power Supply Rejection.
- 4) S/N of the system can be optimized by adjusting the gain setting among 2 steps. (20dB / 26dB)
- 5) Available for Monaural mode.
- 6) Within the wide range of the power supply voltage, it is possible to operate in a single power supply. (10~18V)
- 7) It contributes to miniaturizing, making to the thin type, and the power saving of the system by high efficiency and low heat.
- 8) Eliminates pop noise generated when the power supply goes on/off, or when the power supply is suddenly shut off.
High quality muting performance is realized by using the soft-muting technology.
- 9) This IC is a highly reliable design to which it has various protection functions.
(High temperature protection, under voltage protection, Output short protection, Output DC voltage protection and Clock stop protection, (MCLK, BCLK, LRCLK))
- 10) Small package (HTSSOP-B28 package) contributes to reduction of PCB area.

●Applications

Flat Panel TVs (LCD, Plasma), Home Audio, Desktop PC, Amusement equipments, Electronic Music equipments, etc.

●Absolute maximum ratings (Ta=25°C)

Parameter	Symbol	Ratings	Unit	Parameter
Supply voltage	V _{CC}	22	V	Pin 14, 15, 16, 27, 28 ※1 ※2
Power dissipation	P _d	3.3	W	※3
		4.7	W	※4
Input voltage	V _{IN}	-0.3 ~ 4.5	V	Pin 1 ~ 6, 13 ※1
Terminal voltage 1	V _{PIN1}	-0.3 ~ 7.0	V	Pin 8, 11, 12 ※1
Terminal voltage 2	V _{PIN2}	-0.3 ~ 4.5	V	Pin 9 ※1
Terminal voltage 3	V _{PIN3}	22	V	Pin 17, 18, 20 ~ 23, 25, 26 ※1
Open-drain terminal voltage	V _{ERR}	-0.3 ~ 22	V	Pin 10 ※1
Operating temperature range	T _{opr}	-25 ~ +85	°C	
Storage temperature range	T _{stg}	-55 ~ +150	°C	
Maximum junction temperature	T _{jmax}	+150	°C	

※1 The voltage that can be applied reference to GND (Pin 7, 19, 24).

※2 Do not, however exceed Pd and T_{jmax}=150°C.

※3 70mm×70mm×1.6mm, FR4, 2-layer glass epoxy board (Copper on bottom layer : 70mm×70mm)
Derating in done at 26.4mW/°C for operating above Ta=25°C. There are thermal via on the board.

※4 70mm×70mm×1.6mm, FR4, 4-layer glass epoxy board (Copper on bottom layer : 70mm×70mm)
Derating in done at 37.6mW/°C for operating above Ta=25°C. There are thermal via on the board.

●Operating conditions (Ta=25°C)

Parameter	Symbol	Ratings	Unit	Parameter
Supply voltage	V _{CC}	10 ~ 18	V	Pin 14, 15, 16, 27, 28 ※1 ※2
Minimum load impedance	R _L	3.6	Ω	V _{CC} ≤ 18V ※5
		3.2		V _{CC} ≤ 16V ※5

※5 Do not, however exceed Pd.

※ No radiation-proof design.

●Electrical characteristics

(Unless otherwise specified Ta=25°C, Vcc=12V, f=1kHz, RL=8Ω, RSTX=3.3V, MUTEX=3.3V, Gain=20dB, fs=48kHz
Output LC filter: L=10μH, C=0.1μF)

Parameter	Symbol	Limits			Unit	Conditions
		Min.	Typ.	Max.		
Total circuit						
Circuit current (Reset mode)	I _{CC1}	-	0.1	0.2	mA	Pin 14, 15, 16, 27, 28, No load RSTX=0V, MUTEX=0V
Circuit current (Mute mode)	I _{CC2}	-	15	25	mA	Pin 14, 15, 16, 27, 28, No load RSTX=3.3V, MUTEX=0V
Circuit current (Sampling mode)	I _{CC3}	-	50	80	mA	Pin 14, 15, 16, 27, 28, No load RSTX=3.3V, MUTEX=3.3V
Open-drain terminal Low level voltage	V _{ERR}	-	-	0.8	V	Pin 10, I _O =0.5mA
Regulator output voltage 1	V _{REG_G}	4.7	5.0	5.3	V	Pin 11
Regulator output voltage 2	V _{REG_3}	3.0	3.3	3.6	V	Pin 9
High level input voltage	V _{IH}	2.0	-	3.3	V	Pin 1 ~ 6, 13
Low level input voltage	V _{IL}	0	-	0.9	V	Pin 1 ~ 6, 13
Input current (Input pull-down terminal)	I _{IH}	50	66	95	μA	Pin 1 ~ 6, 13, V _{IN} = 3.3V
Speaker Output						
Maximum output power 1	P _{O1}	-	10	-	W	THD+n=10% GAIN=20dB ※6
Maximum output power 2	P _{O2}	-	15	-	W	VCC=15V, THD+n=10% GAIN =26dB ※6
Voltage gain	G _{V20}	19	20	21	dB	P _O =1W, Gain=20dB ※6
	G _{V26}	25	26	27	dB	P _O =1W, Gain=26dB ※6
Total harmonic distortion	THD	-	0.07	-	%	P _O =1W, BW=20~20kHz ※6
Crosstalk	CT	66	80	-	dB	P _O =1W, BW=IHF-A ※6
PSRR	PSRR	-	70	-	dB	V _{ripple} =1V _{rms} , f= 1kHz ※6
Output noise voltage (Sampling mode)	V _{NO}	-	100	200	μV _{rms}	-∞dBFS, BW=IHF-A ※6
PWM sampling frequency	f _{PWM1}	-	256	-	kHz	fs=32kHz ※6
	f _{PWM2}	-	352.8	-	kHz	fs=44.1kHz ※6
	f _{PWM3}	-	384	-	kHz	fs=48kHz ※6

※6 These items show the typical performance of device and depend on board layout, parts, and power supply.
The standard value is in mounting device and parts on surface of ROHM's board directly.

●Electrical characteristic curves (VCC=12V, Ta=25°C, RL=8Ω, Gain=26dB, fin=1kHz, fs=48kHz)

Measured by ROHM designed 4 layer board.

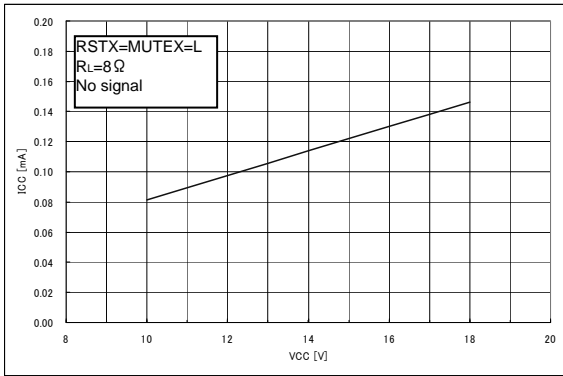

Fig.1
Current consumption - Power supply voltage

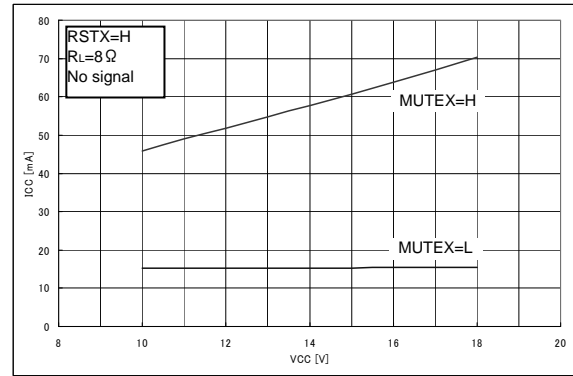

Fig.2
Current consumption - Power supply voltage

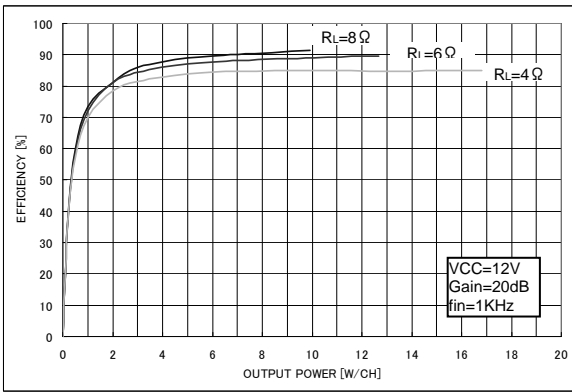

Fig.3
Efficiency - Output power

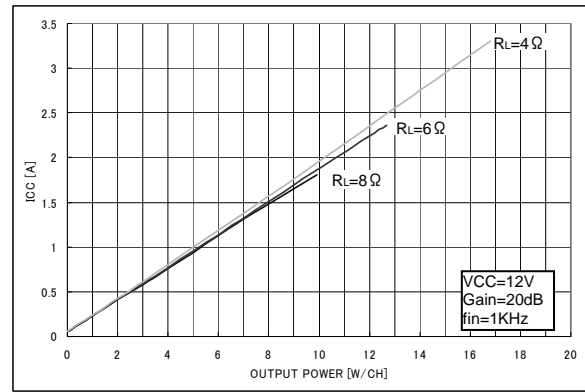

Fig.4
Current consumption - Output power

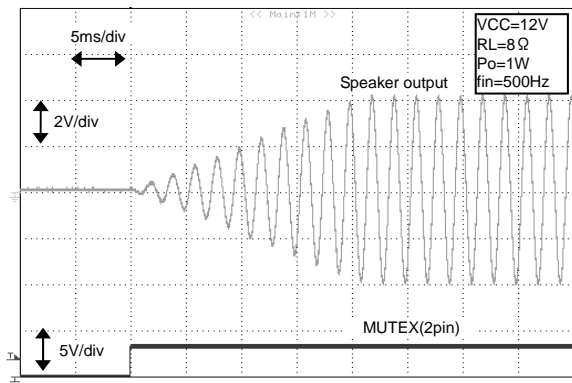

Fig.5
Wave form when releasing soft-mute

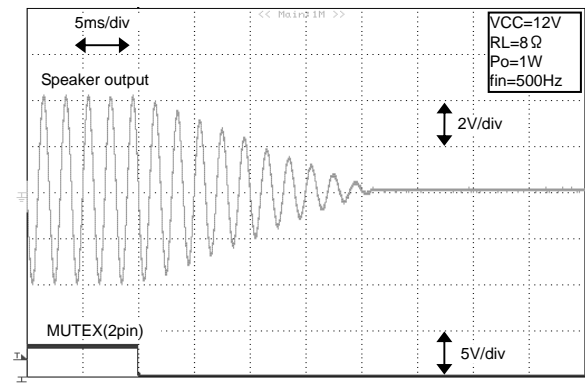

Fig.6
Wave form when activating soft-mute

●Electrical characteristics (VCC=12V, Gain=26dB, fin=1kHz, fs=48kHz)
 Measured by ROHM designed 4 layer board.

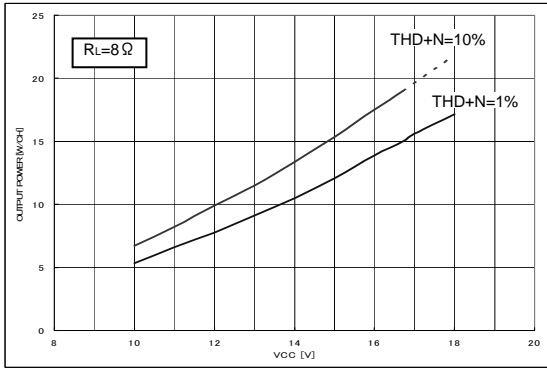

Fig.7
 Output power – Power supply voltage

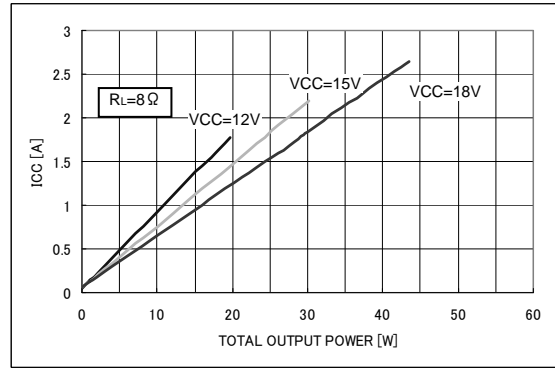

Fig.8
 Current consumption - Output power

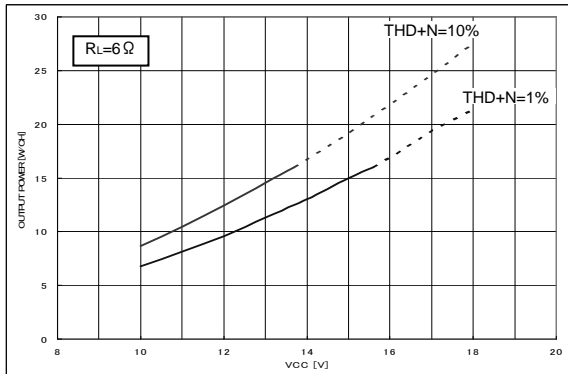

Fig.9
 Output power – Power supply voltage

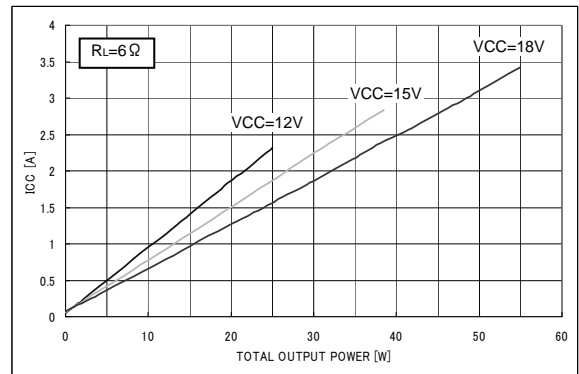

Fig.10
 Current consumption - Output power

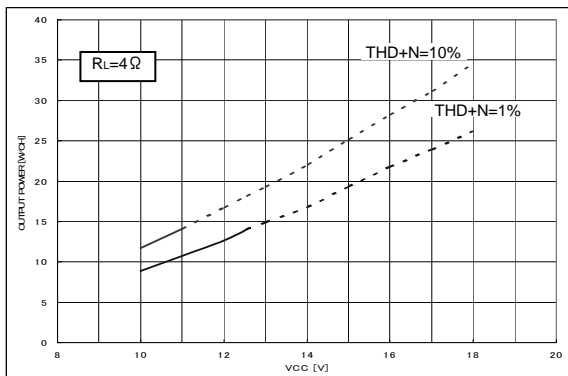

Fig.11
 Output power – Power supply voltage

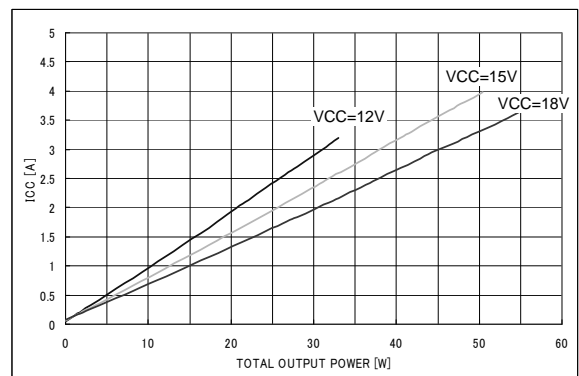

Fig.12
 Current consumption - Output power

※Dotted line means internal dissipation is over package power.

●Electrical characteristic curves(VCC=12V, Ta=25°C, RL=8Ω, Gain=20dB, fin=1kHz, fs=48kHz)

Measured by ROHM designed 4layer board.

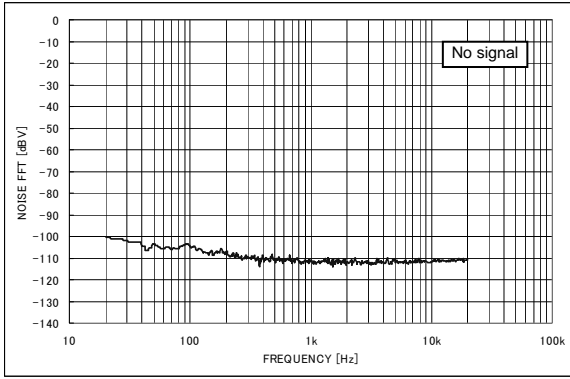

Fig.13
FFT of output noise voltage

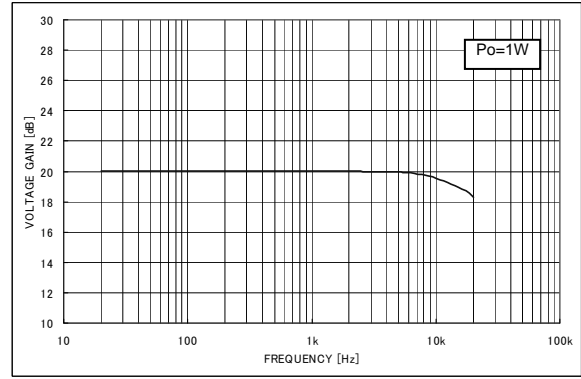

Fig.14
Voltage gain - Frequency

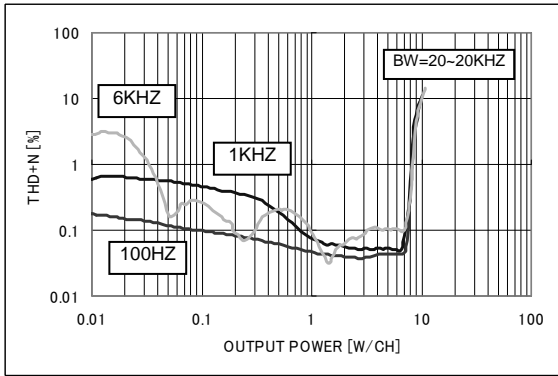

Fig.15
THD+N - Output power

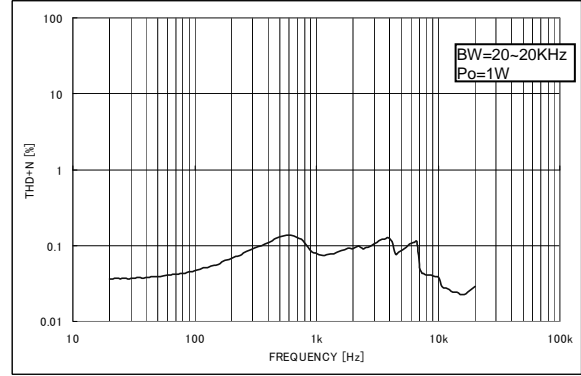

Fig.16
THD+N - Frequency

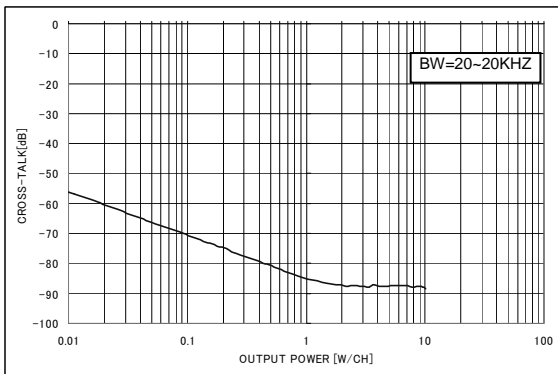

Fig.17
Crosstalk - Output power

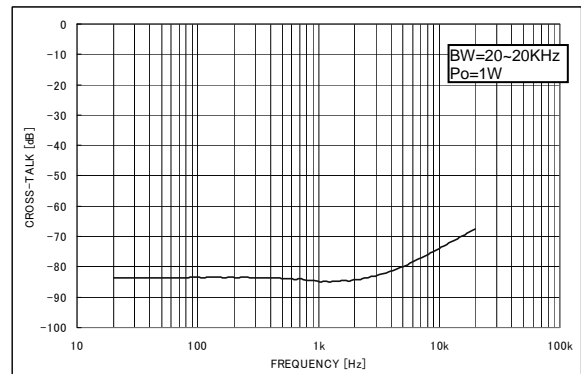

Fig.18
Crosstalk - Frequency

●Electrical characteristic curves(VCC=12V, Ta=25°C, RL=6Ω, Gain=20dB, fin=1kHz, fs=48kHz)

Measured by ROHM designed 4layer board

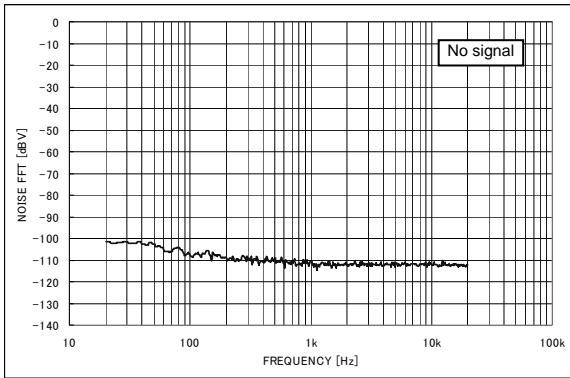

Fig.19
FFT of output noise voltage

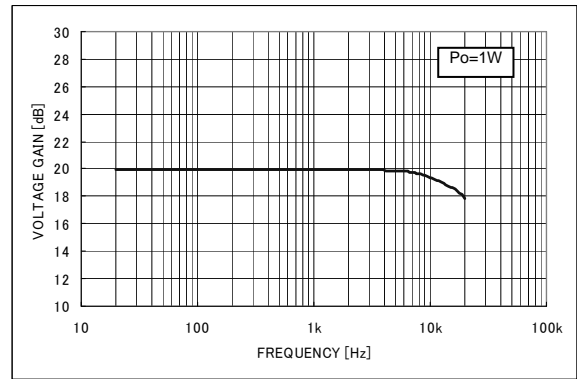

Fig.20
Voltage gain - Frequency

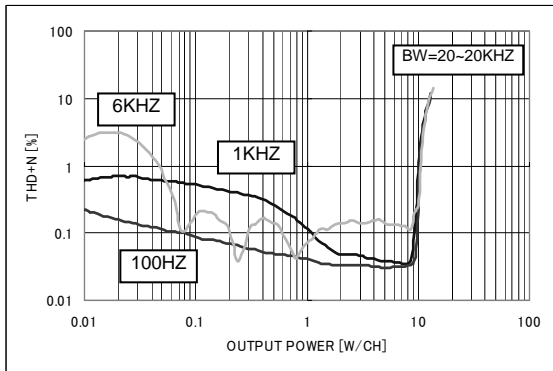

Fig.21
THD+N - Output power

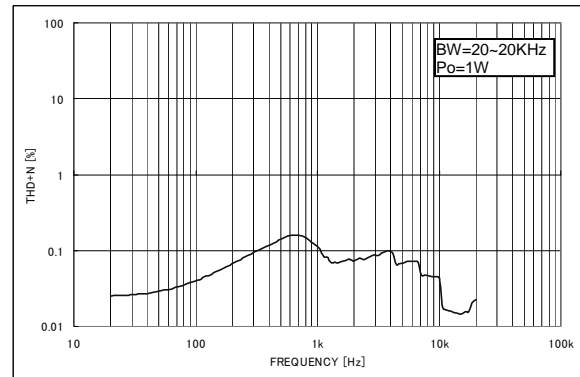

Fig.22
THD+N - Frequency

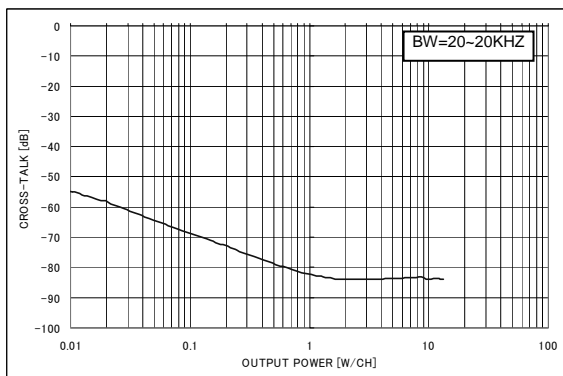

Fig.23
Crosstalk - Output power

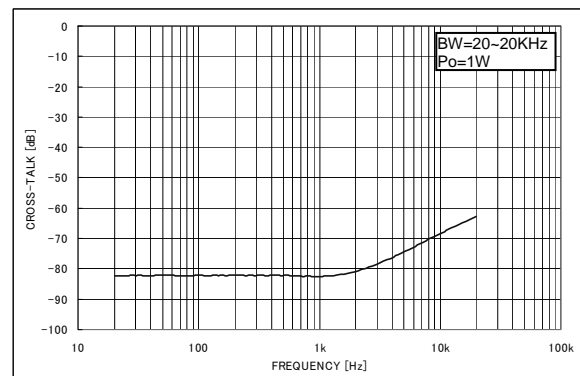

Fig.24
Crosstalk - Frequency

●Electrical characteristic curves(VCC=12V, Ta=25°C, RL=4Ω, Gain=20dB, fin=1kHz, fs=48kHz)

Measured by ROHM designed 4layer board

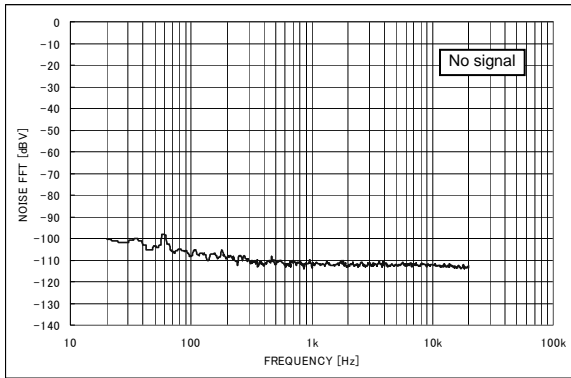

Fig.25
FFT of output noise voltage

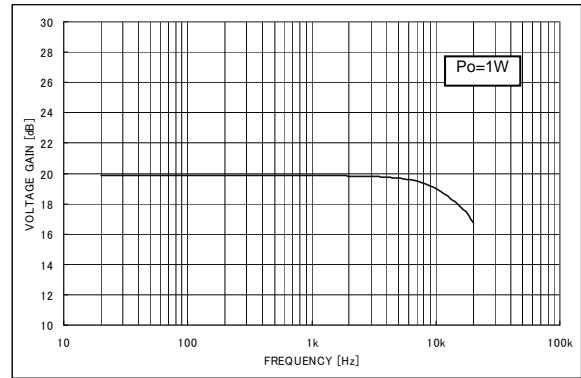

Fig.26
Voltage gain - Frequency

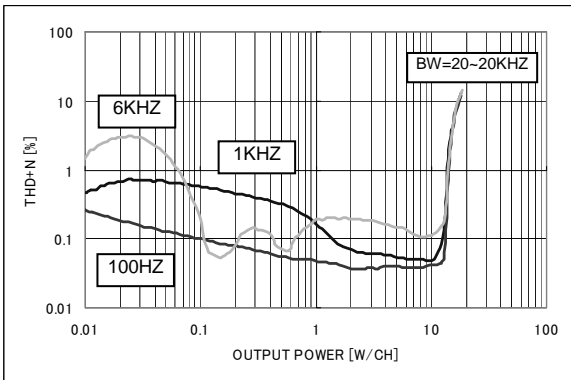

Fig.27
THD+N - Output power

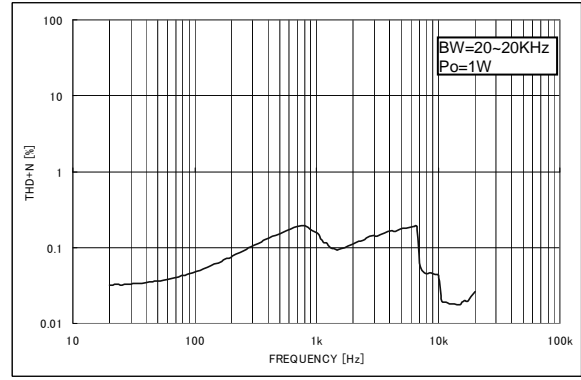

Fig.28
THD+N - Frequency

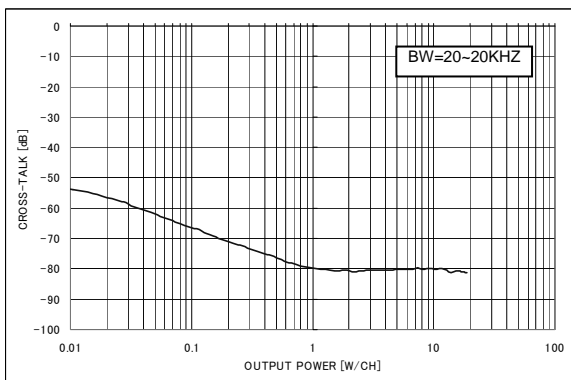

Fig.29
Crosstalk - Output power

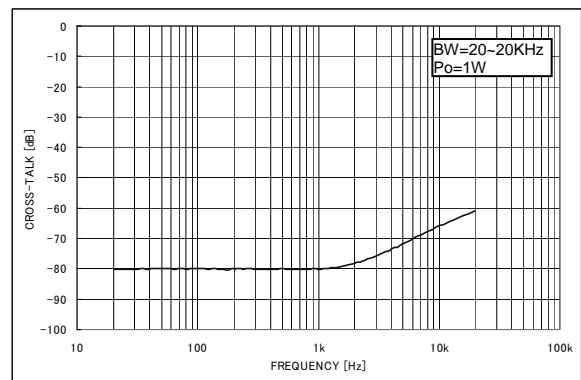
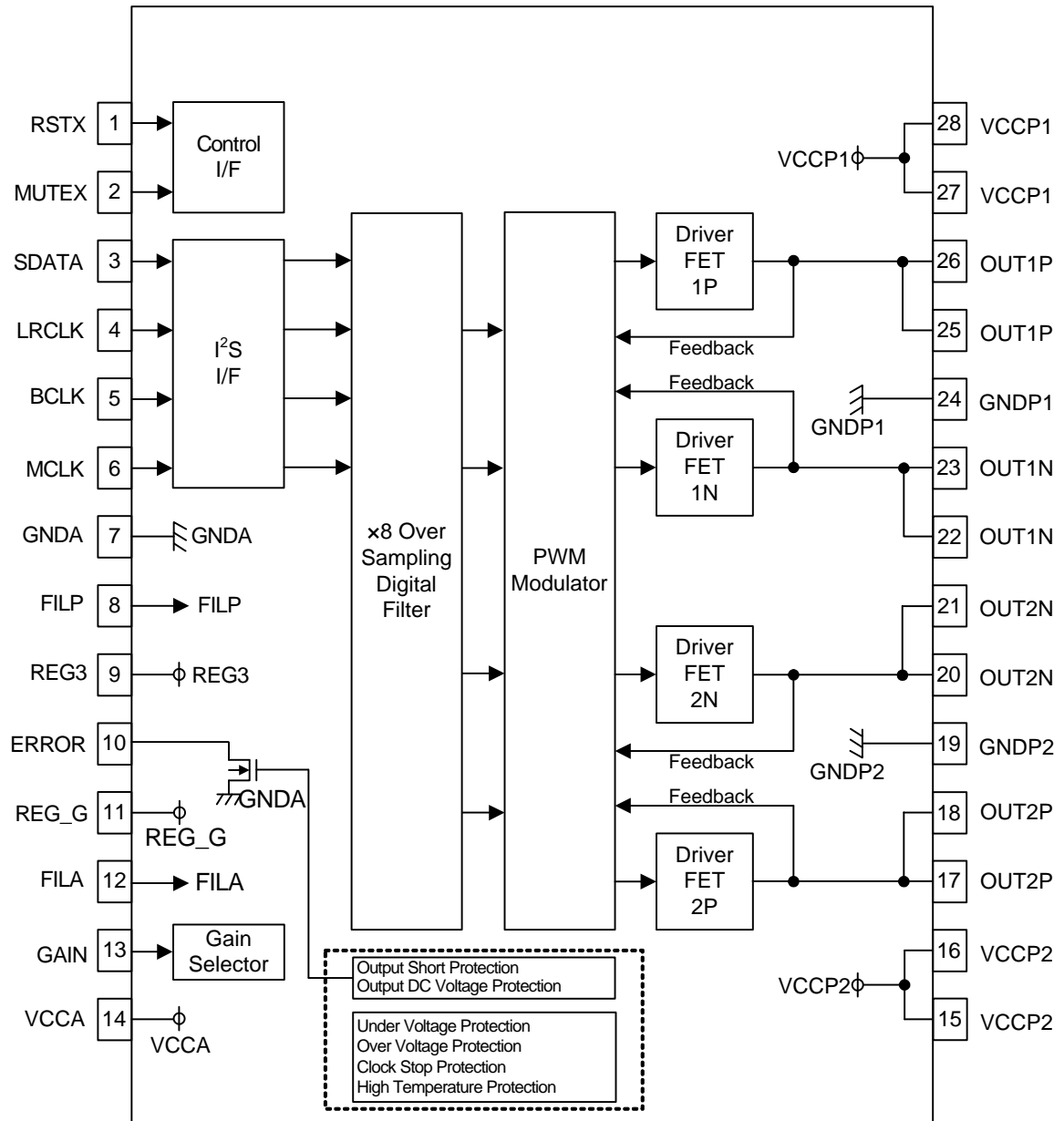

Fig.30
Crosstalk - Frequency

● Pin configuration and Block diagram



●Pin function explanation (Provided pin voltages are typ. Values)

Pin No.	Pin name	Pin voltage	Pin explanation	Internal equivalence circuit
1	RSTX	0V	Reset pin for Digital circuit H: Reset OFF L: Reset ON	
2	MUTEX	0V	Speaker output mute control pin H: Mute OFF L: Mute ON	
3	SDATA		Digital audio signal input pin	
4	LRCLK			
5	BCLK			
6	MCLK			
12	GAIN		Gain setting terminal L: 20dB H: 26dB	
7	GNDA	0V	GND pin for Analog signal	-
8	FILP	1.75V~2.55V	Bias pin for PWM signal Please connect the capacitor.	
9	REG3	3.3V	Internal power supply pin for Digital circuit Please connect the capacitor.	
10	ERROR	3.3V	Error flag pin Please connect pull-up resistor. H: While Normal L: While Error	
11	REG_G	5.2V	Internal power supply pin for Gate driver Please connect the capacitor.	

Pin No.	Pin name	Pin voltage	Pin explanation	Internal equivalence circuit
12	FILA	2.5V	Bias pin for PWM signal. Please connect the capacitor.	
14	VCCA	Vcc	Power supply pin for Analog signal	—
15,16	VCCP2	Vcc	Power supply pin for ch2 PWM signal Please connect the capacitor.	
17,18	OUT2P	Vcc~0V	Output pin of ch2 positive PWM Please connect to Output LPF.	
19	GNDP2	0V	GND pin for ch2 PWM signal	
20,21	OUT2N	Vcc~0V	Output pin of ch2 negative PWM Please connect to Output LPF.	
22,23	OUT1N	Vcc~0V	Output pin of ch1 negative PWM Please connect to Output LPF.	
24	GNDP1	0V	GND pin for ch1 PWM signal	
25,26	OUT1P	Vcc~0V	Output pin of ch1 positive PWM Please connect to Output LPF.	
27,28	VCCP1	—	Power supply pin for ch1 PWM signal Please connect the capacitor.	

● Terminal setting

(1) Gain pin function

GAIN (13pin)	Speaker output gain
L	20dB
H	26dB

(2) RSTX pin, MUTEX pin function

RSTX (1pin)	MUTEX (2pin)	Normalcy		Error detecting	
		PWM output (OUT1P, 1N, 2P, 2N)	ERROR Output	PWM output (OUT1P, 1N, 2P, 2N)	ERROR Output
L	L or H	HiZ_L (Reset mode)	H	HiZ_L (Reset mode)	H
H	L	HiZ_L (MUTE ON)	H	HiZ_L (MUTE ON)	L
H	H	Normal operation (MUTE OFF)	H	HiZ_L (MUTE ON)	L

※RSTX(1pin)terminal, MUTEX(2pin)terminal are internally pulled down by 50 kΩ (Typ.)

※With RSTX=L data of every register within IC (I²S / I/F part, × 8 over sampling digital filter part, latch circuit when detecting ERROR) becomes unnecessary.

● Input digital audio signal sampling frequency (fs) explanation

PWM sampling frequency, Soft-start, Soft-mute time, and the detection time of the DC voltage protection in the speaker depends on sampling frequency (fs) of the digital audio input.

Sampling frequency of the digital audio input (fs)	PWM sampling frequency (fpwm)	Soft-start / Soft-mute time	DC voltage protection in the speaker detection time
32kHz	256kHz	32msec.	64msec.
44.1kHz	352.8kHz	23msec.	46msec.
48kHz	384kHz	21.5msec.	43msec.

● For voltage gain (Gain setting)

BD5451EFV prescribe voltage gain at speaker output (BTL output) under the definition 0dBV (1Vrms) as full scale input of the digital audio input signal. For example, digital audio input signal = -20dBFS (0.1Vrms), Gain setting = 20dB, Load resistance $R_L = 8\Omega$ will give speaker output (BTL output) amplitude as $V_o=1Vrms$. (Output power $P_o = V_o^2/R = 0.125W$)

●Format of digital audio input

- MCLK: It is System Clock input signal.
It will input LRCLK, BCLK, SDATA that synchronizes with this clock that are 256 times of sampling frequency (256fs).
- LRCLK: It is L/R clock input signal.
It corresponds to 32kHz / 44.1kHz / 48kHz with those clock (fs) that are same to the sampling frequency (fs) .
The data of a left channel and a right channel for one sample is input to this section.
- BCLK: It is Bit Clock input signal.
It is used for the latch of data in every one bit by sampling frequency's 64 times sampling frequency (64fs).
- SDATA: It is Data input signal.
It is amplitude data. The data length is different according to the resolution of the input digital audio data.
It corresponds to 16/ 20/ 24 bit.

●I²S data format

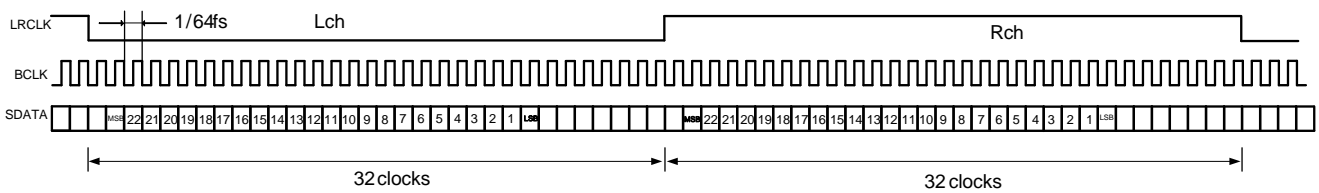

Fig.31 I²S Data Format 64fs, 24 bit Data

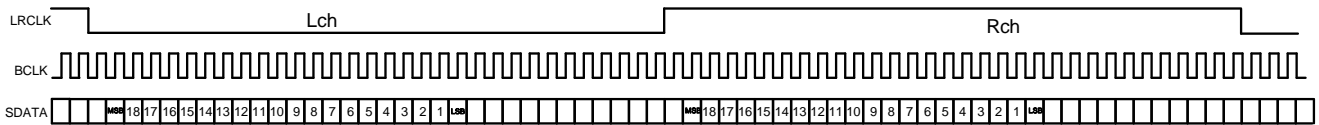

Fig.32 I²S Data Format 64fs, 20 bit Data

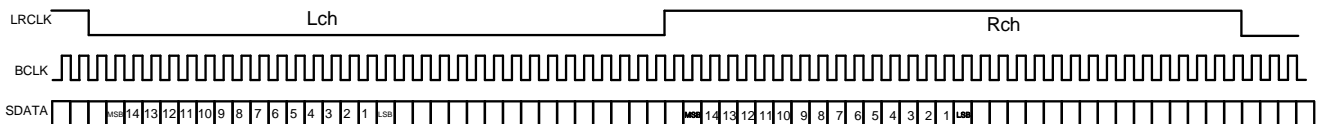

Fig.33 I²S Data Format 64fs, 16 bit Data

The Low section of LRCLK becomes Lch, the High section of LRCLK becomes Rch.
After changing LRCLK, second bit becomes MSB.

●Audio Interface format and timing

Recommended timing and operating conditions (MCLK, BCLK, LRCLK, SDATA)

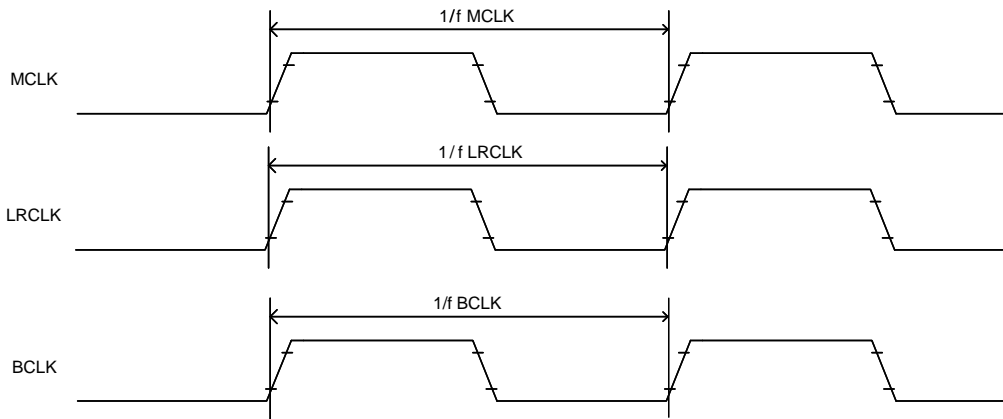

Fig.34 Clock timing

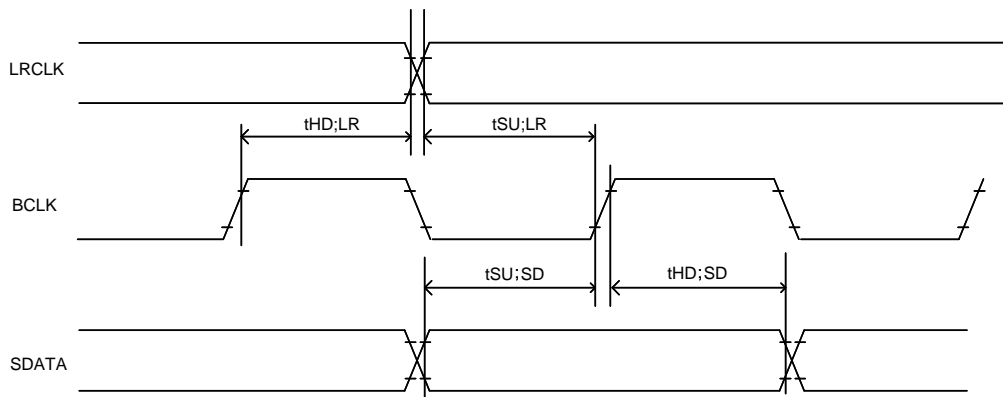

Fig.35 Audio Interface timing (1)

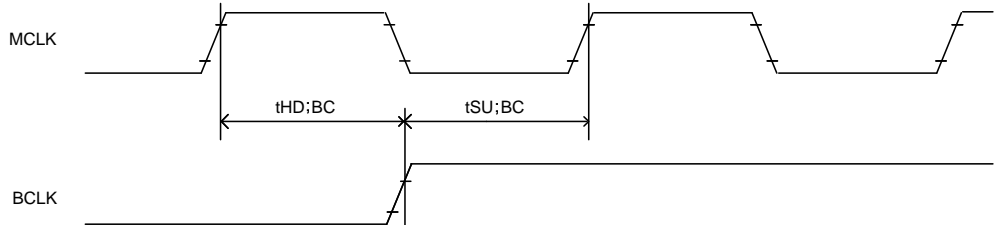

Fig.36 Audio Interface timing (2)

Parameter	Symbol	Limit		Unit
		Min.	Max.	
1 MCLK frequency	fMCLK	8.192	12.288	MHz
2 LRCLK frequency	fLRCLK	32	48	kHz
3 BCLK frequency	fBCLK	2.048	3.072	MHz
4 Setup time, LRCLK※1	tSU;LR	20	—	ns
5 Hold time, LRCLK※1	tHD;LR	20	—	ns
6 Setup time, SDATA	tSU;SD	20	—	ns
7 Hold time, SDATA	tHD;SD	20	—	ns
8 Setup time, BCLK※2	tSU;BC	3	—	ns
9 Hold time, BCLK※2	tHD;BC	7	—	ns

※1 This regulation is to keep rising edge of LRCK and rising edge of BCLK from overlapping.

※2 This regulation is to keep rising edge of MCLK and rising edge of BCLK from overlapping.

●Power supply start-up sequence

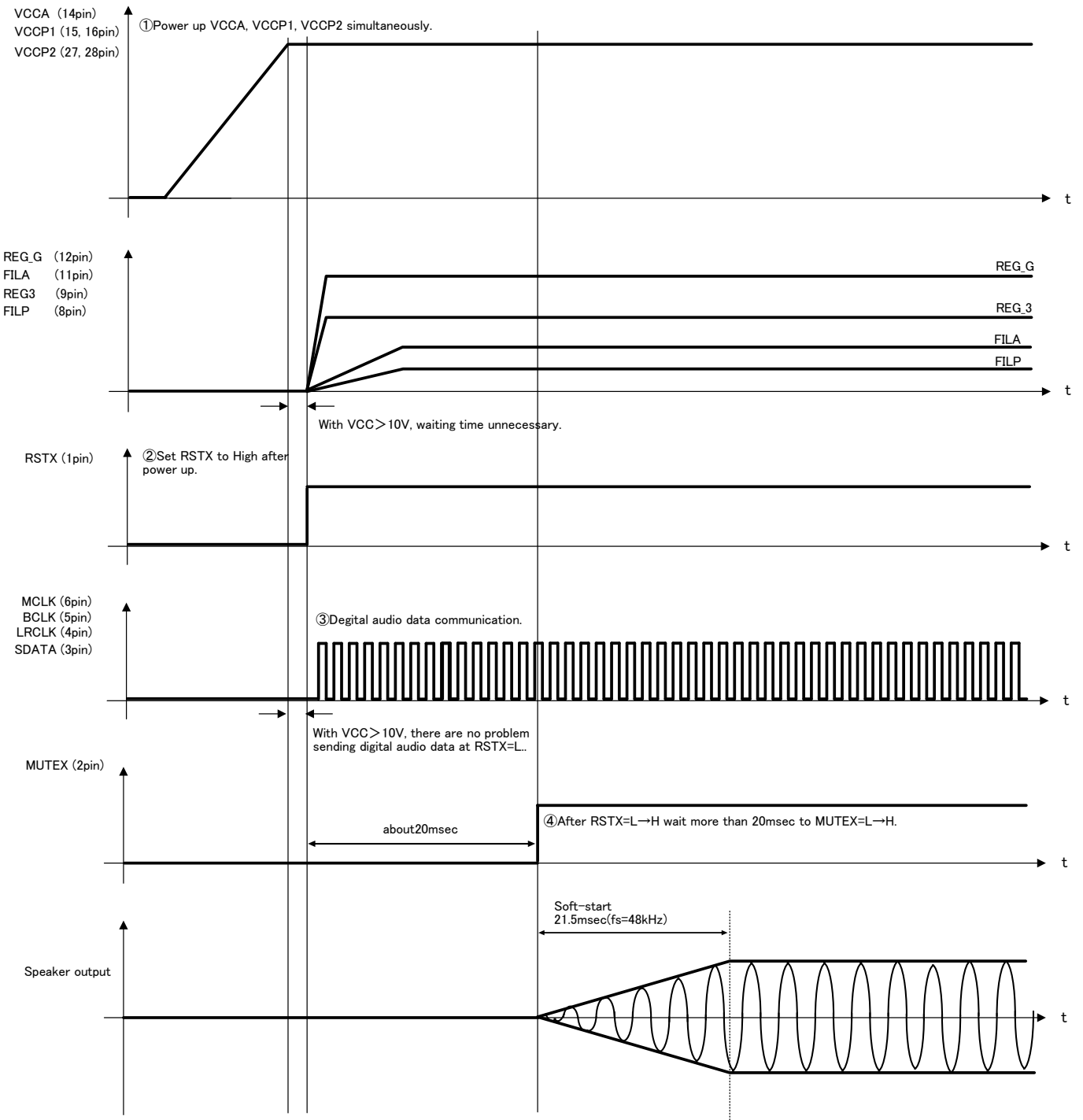

●Power supply shut-down sequence

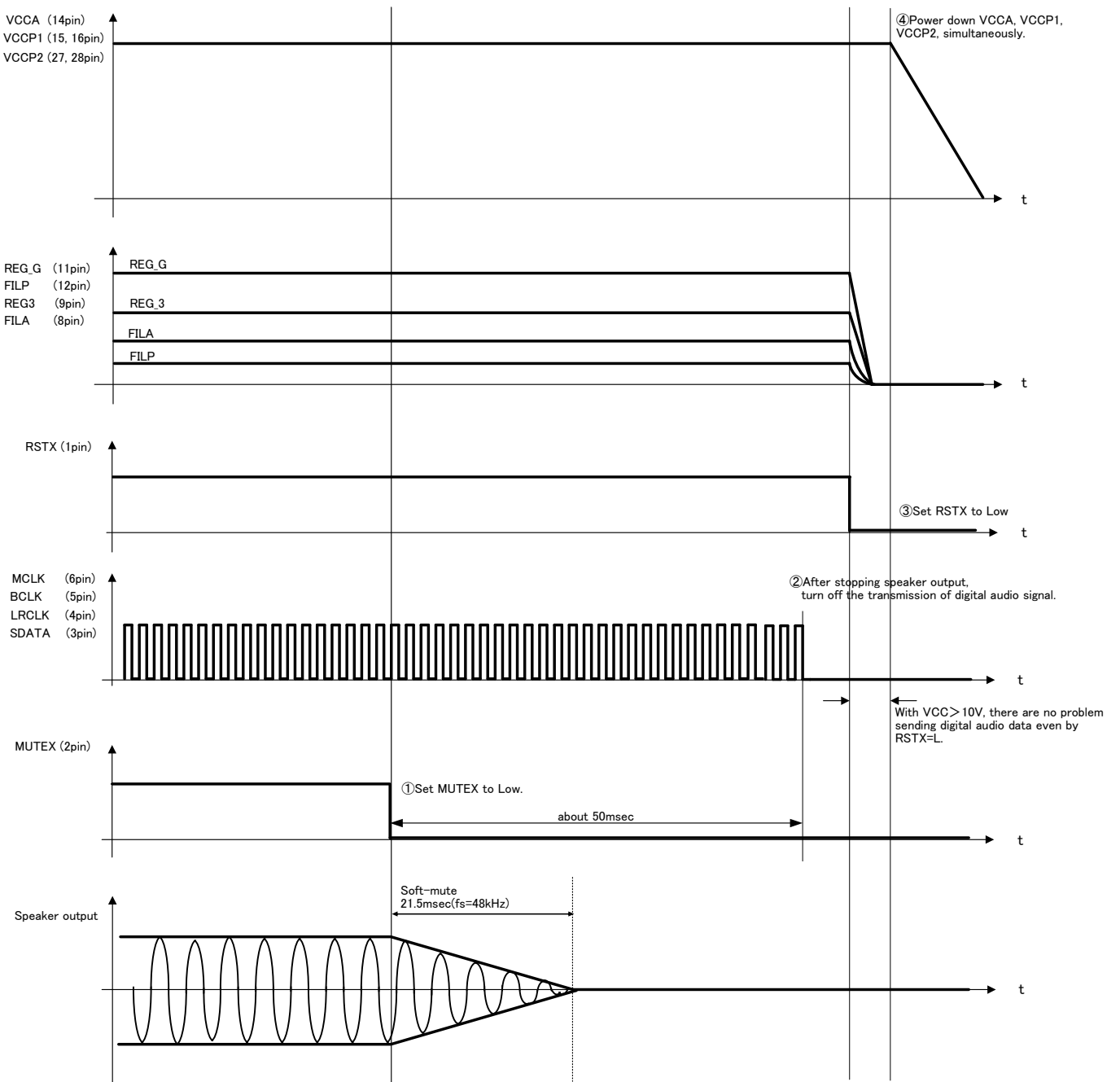

●About the protection function

Protection function	Detecting & Releasing condition		PWM Output	ERROR Output
Output short protection	Detecting condition	Detecting current = 10A (TYP.)	HiZ_Low (Latch)	L (Latch)
DC voltage protection in the speaker	Detecting condition	PWM output Duty=0% or 100% 43msec(fs=48kHz) above fixed	HiZ_Low (Latch)	L (Latch)
High temperature protection	Detecting condition	Chip temperature to be above 150°C (TYP.)	HiZ_Low	H
	Releasing condition	Chip temperature to be below 120°C (TYP.)	Normal operation	
Under voltage protection	Detecting condition	Power supply voltage to be below 8V (TYP.)	HiZ_Low	H
	Releasing condition	Power supply voltage to be above 9V (TYP.)	Normal operation	
Over voltage Protection	Detecting condition	Power supply voltage to be above 21.5V(TYP.)	HiZ_Low	H
	Releasing condition	Power supply voltage to be below 20.5V(TYP.)	Normal operation	
Clock stop protection	Detecting condition	No change to MCLK more than 1μsec (TYP.) or no change to BCLK more than 1μsec (TYP.) or no change to LRCLK more than 21μsec (at fs=48kHz.).	HiZ_Low	H
	Releasing condition	Normal input to MCLK, BCLK and LRCLK.	Normal operation	

* The ERROR pin is Nch open-drain output.

* Once an IC is latched, the circuit is not released automatically even after an abnormal status is removed.

The following procedures ① or ② is available for recovery.

①After turning MUTEX terminal to Low(holding time to Low = 10msec(Min.)) turn back to High again.

②Restore power supply after dropping to power supply voltage $V_{cc} < 3V$ (10msec (Min.) holding) which internal power on reset circuit activates.

1) Output short protection(Short to the power supply)

This IC has the PWM output short protection circuit that stops the PWM output when the PWM output is short-circuited to the power supply due to abnormality.

Detecting condition - It will detect when MUTE_X pin is set High and the current that flows in the PWM output pin becomes 10A(TYP.) or more. The PWM output instantaneously enters the state of HiZ-Low if detected, and IC does the latch.

Releasing method - ①After turning MUTE_X terminal to Low(holding time to Low = 10msec(Min.)) turn back to High again.

②Restore power supply after dropping to power supply voltage $V_{CC} < 3V$ (10msec (Min.) holding) which internal power on reset circuit activates.

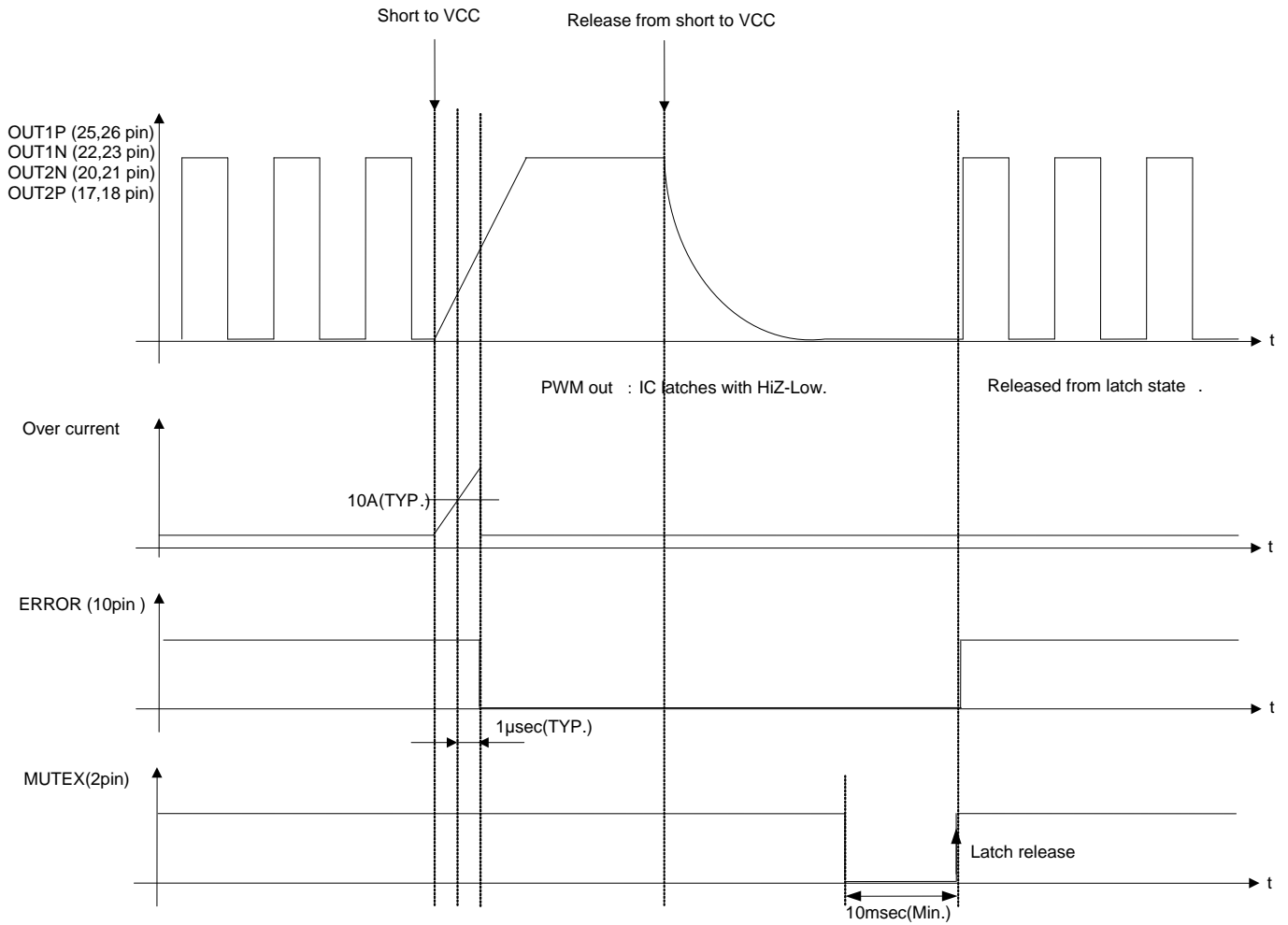

2) Output short protection(Short to GND)

This IC has the PWM output short protection circuit that stops the PWM output when the PWM output is short-circuited to GND due to abnormality.

Detecting condition - It will detect when MUTEX pin is set High and the current that flows in the PWM output terminal becomes 10A(TYP.) or more. The PWM output instantaneously enters the state of HiZ-Low if detected, and IC does the latch.

Releasing method - ①After turning MUTEX terminal to Low(holding time to Low = 10msec(Min.)) turn back to High again.

②Restore power supply after dropping to power supply voltage $V_{cc} < 3V$ (10msec (Min.) holding) which internal power on reset circuit activates.

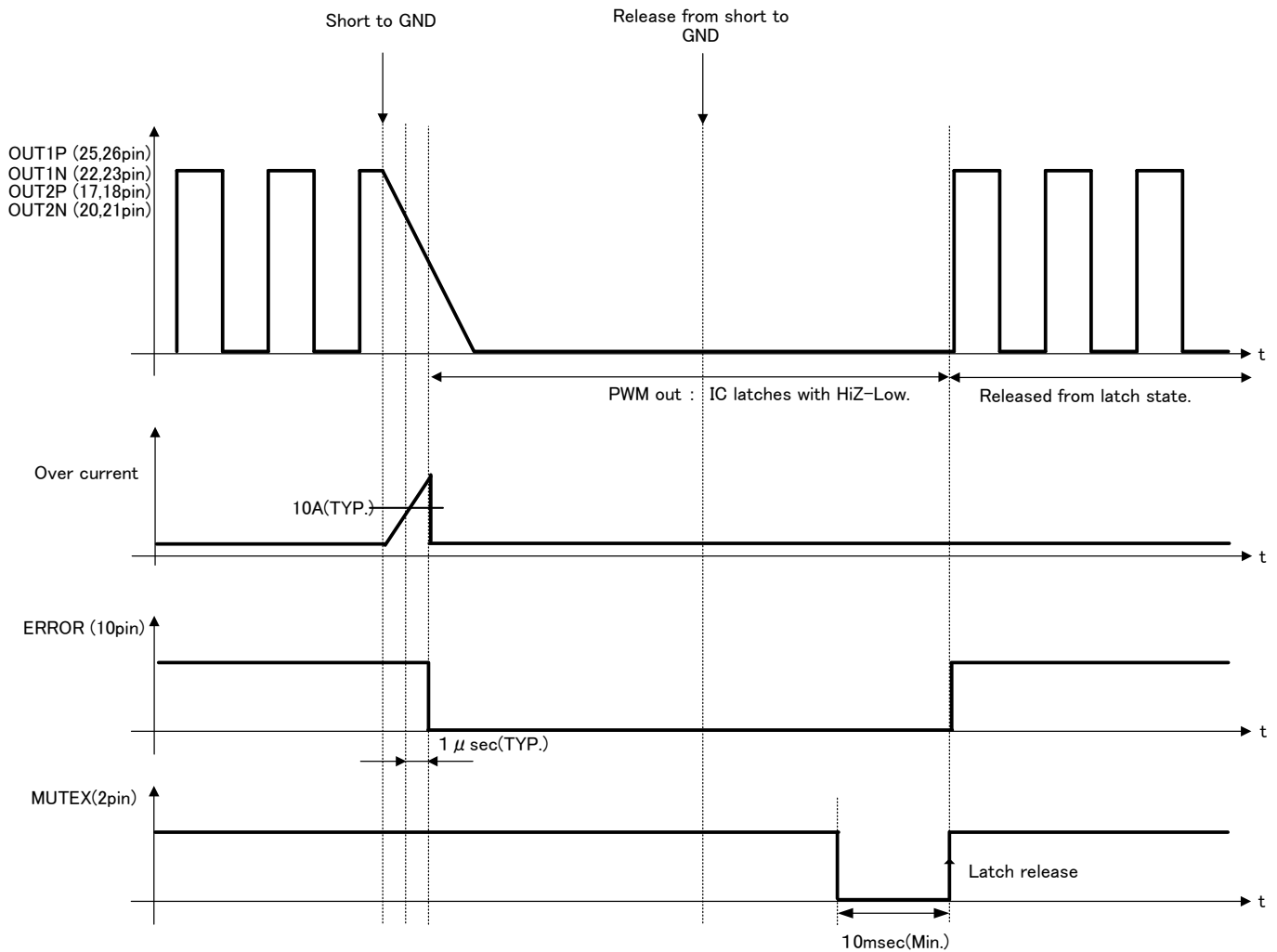

3)DC voltage protection in the speaker

When the DC voltage in the speaker is impressed due to abnormality, this IC has the protection circuit where the speaker is defended from destruction.

Detecting condition - It will detect when MUTE_X pin is set High or Low and PWM output Duty=0% or 100% , 43msec(fs=48kHz) or above. Once detected, The PWM output instantaneously enters the state of HiZ-Low, and IC does the latch.

Releasing method – ①After turning MUTE_X terminal to Low(holding time to Low = 10msec(Min.)) turn back to High again.

②Restore power supply after dropping to power supply voltage V_{cc}<3V(10msec (Min.) holding) which internal power on reset circuit activates.

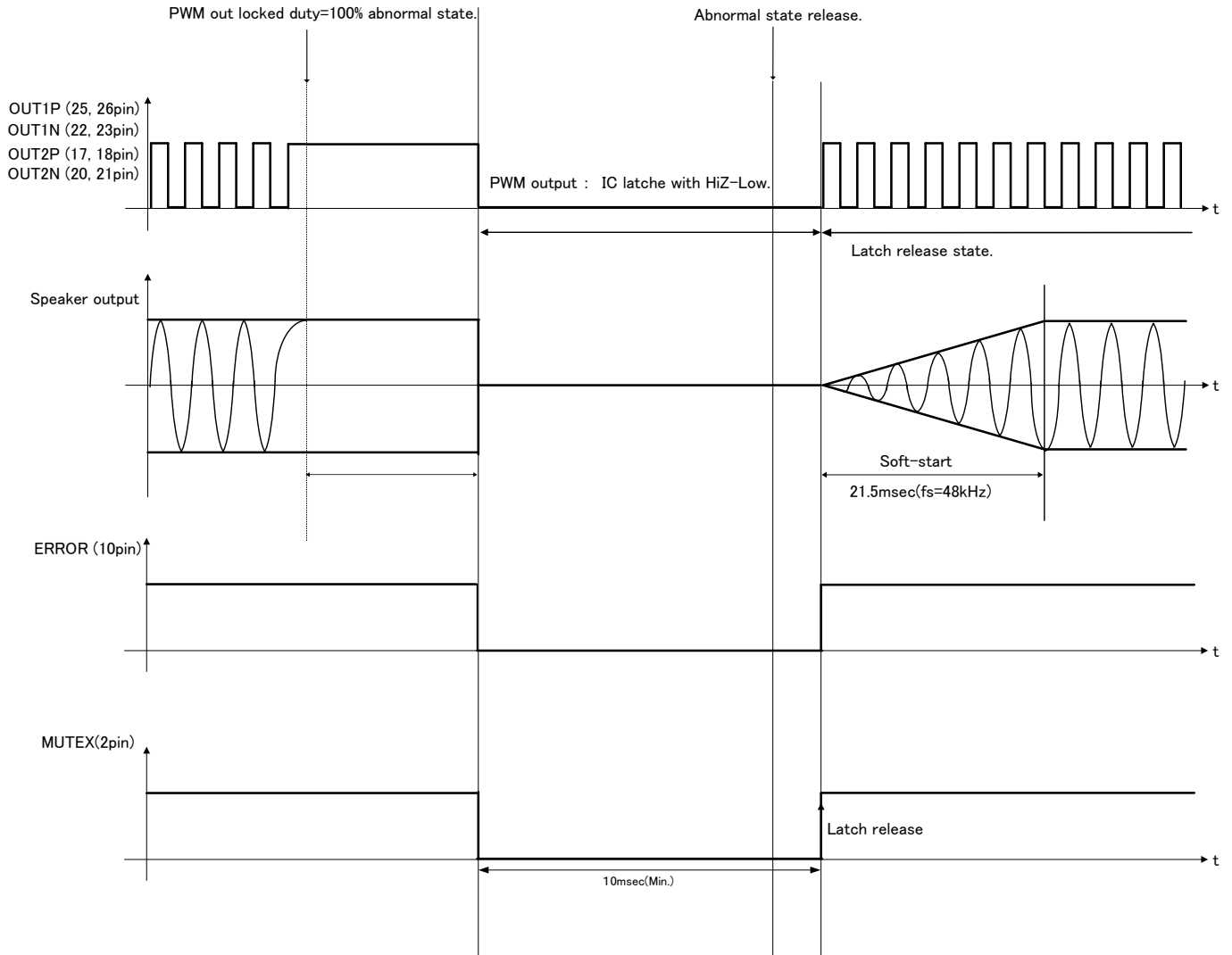

4) High temperature protection

This IC has the high temperature protection circuit that prevents thermal reckless driving under an abnormal state for the temperature of the chip to exceed $T_{jmax}=150^{\circ}\text{C}$.

Detecting condition - It will detect when MUTEX pin is set High and the temperature of the chip becomes 150°C (TYP.) or more. Speaker output turn MUTE immediately, when High temperature protection is detected.

Releasing condition - It will release when MUTEX pin is set High and the temperature of the chip becomes 120°C (TYP.) or less. The speaker output is outputted through a soft-start when released.

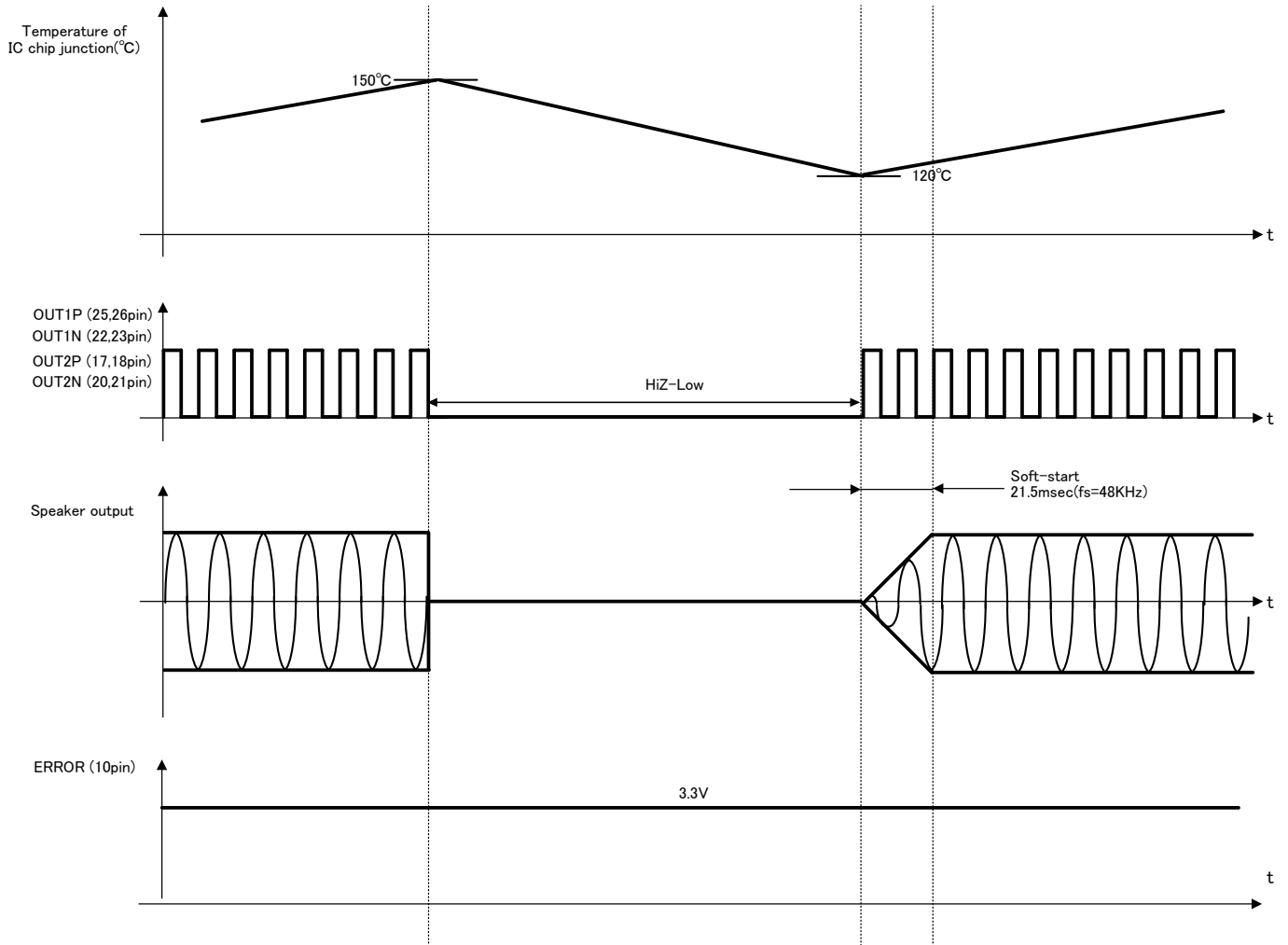

5) Under voltage protection

This IC has the under voltage protection circuit that make speaker output mute once detecting extreme drop of the power supply voltage.

Detecting condition – It will detect when MUTEX pin is set High and the power supply voltage becomes lower than 8V. Speaker output turn MUTE immediately, when Under voltage protection is detected.

Releasing condition – It will release when MUTEX pin is set High and the power supply voltage becomes more than 9V. The speaker output is outputted through a soft-start when released.

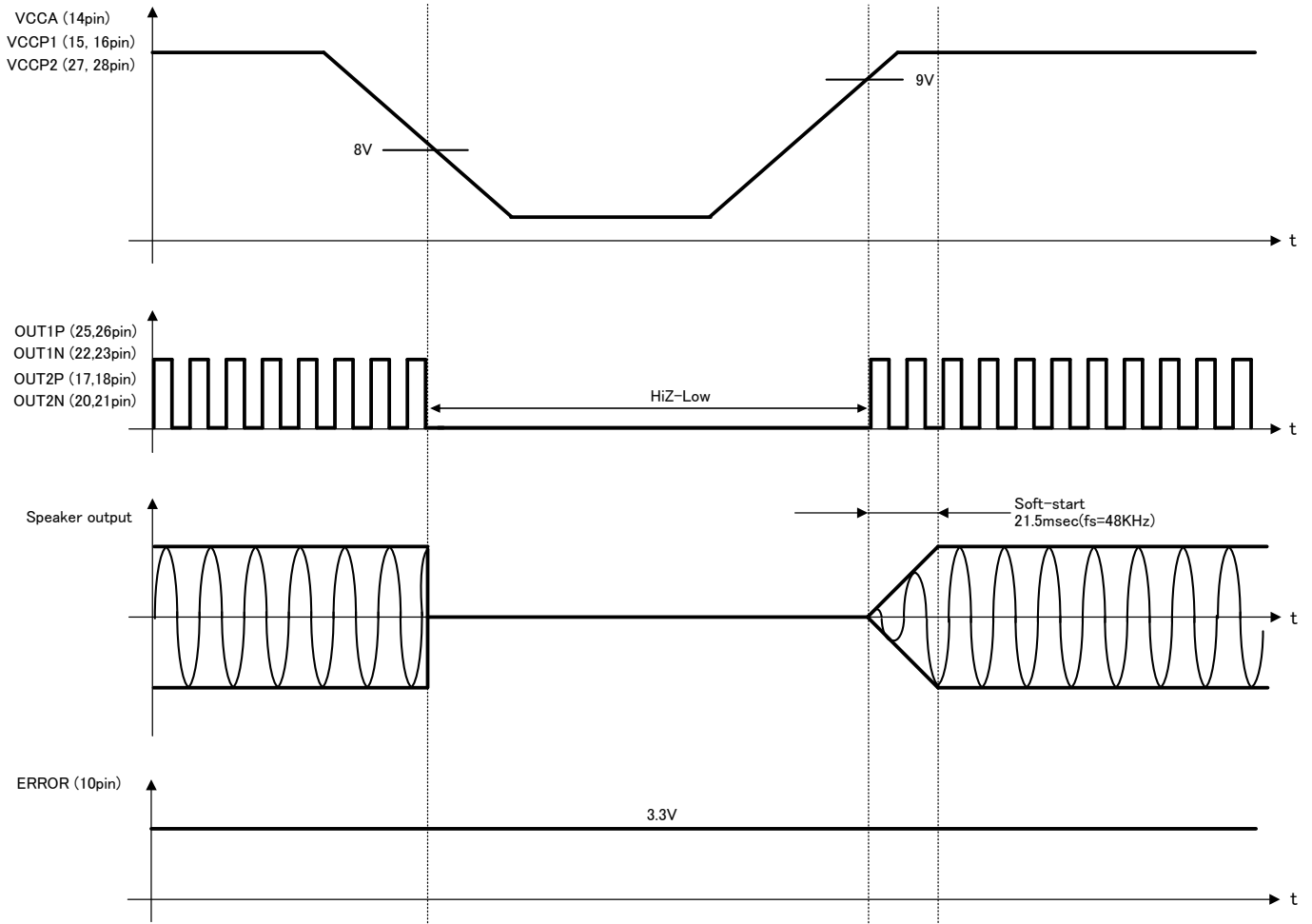

6) Over voltage protection

This IC has the under voltage protection circuit that make speaker output mute once detecting extreme drop of the power supply voltage.

Detecting condition – It will detect when MUTEX pin is set High and the power supply voltage becomes more than 21.5V. Speaker output turn MUTE immediately, when over voltage protection is detected.

Releasing condition – It will release when MUTEX pin is set High and the power supply voltage becomes lower than 20.5V. The speaker output is outputted through a soft-start when released.

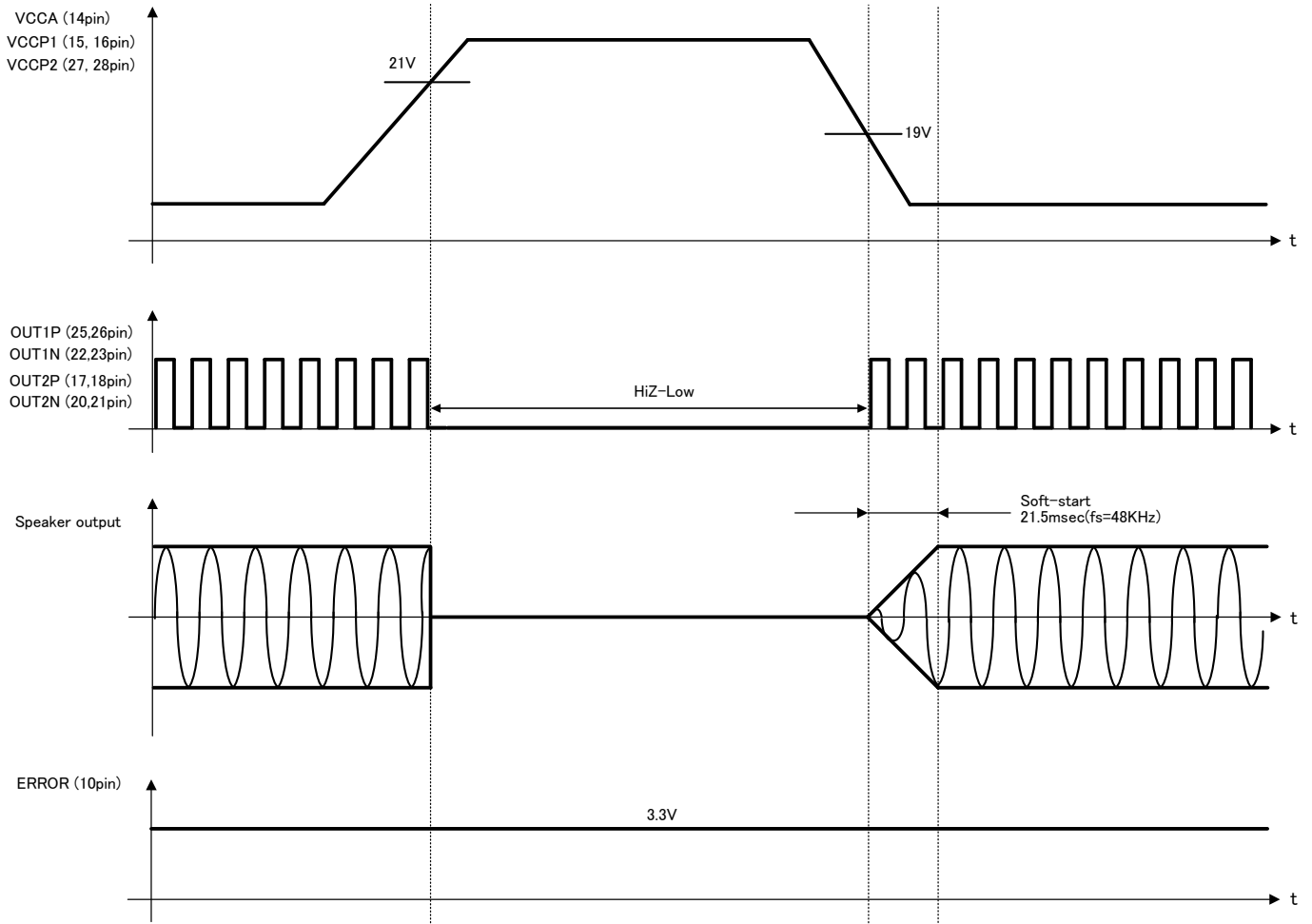

7-1) Clock stop protection(MCLK)

This IC has the clock stop protection circuit that make the speaker output mute when the MCLK signal of the digital audio input stops.

Detecting condition - It will detect when MUTEX pin is set High and the MCLK signal stops for about 1 μ sec or more. 21.5V. Speaker output turn MUTE immediately, clock stop protection is detected.

Releasing condition - It will release when MUTEX pin is set High and the MCLK signal returns to the normal clock operation. The speaker output is outputted through a soft-start when released.

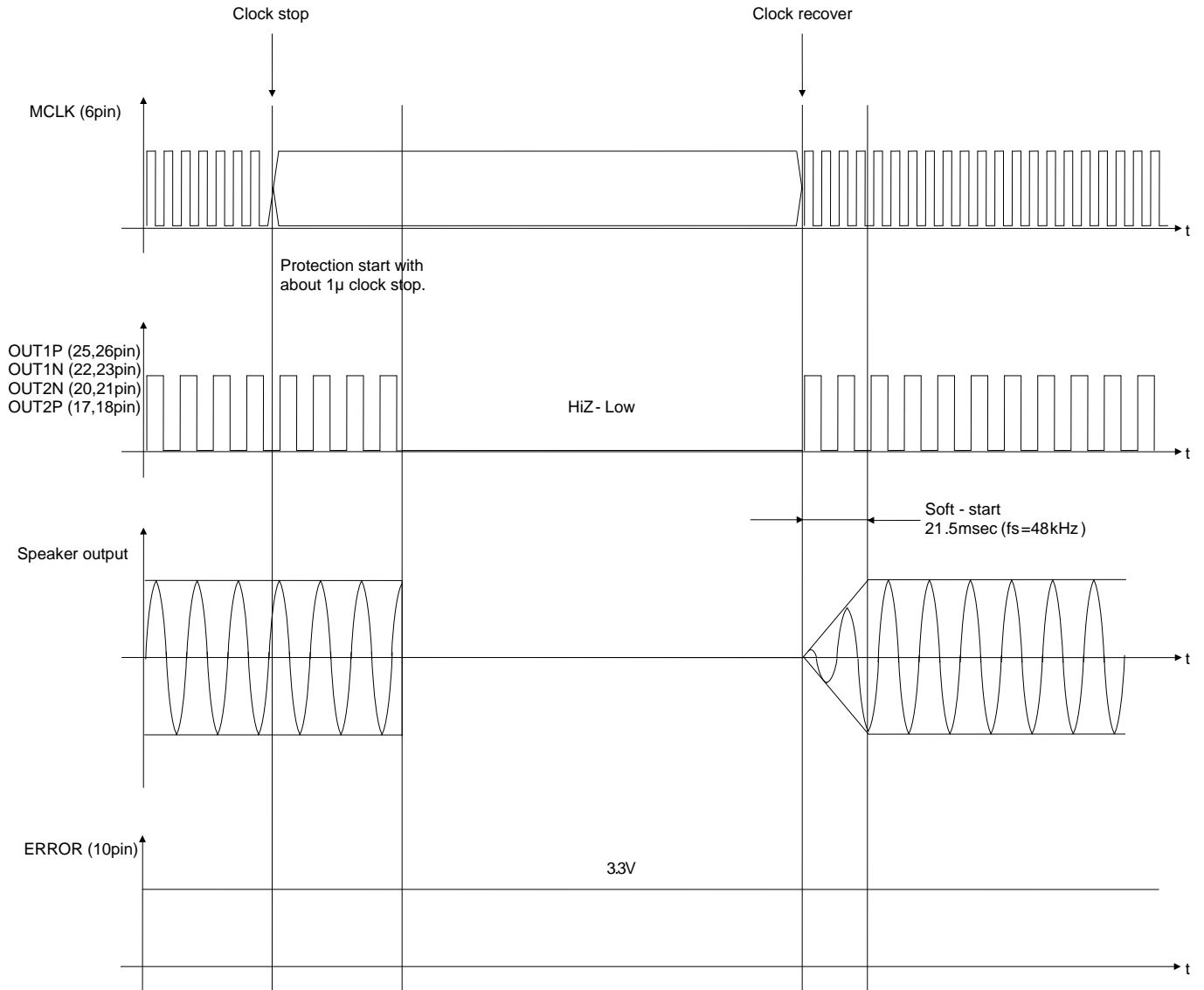

7-2) Clock stop protection(BCLK)

This IC has the clock stop protection circuit that make the speaker output mute when the BCLK signal of the digital audio input stops.

Detecting condition - It will detect when MUTEX pin is set High and the BCLK signal stops for about 1 μ sec or more. 21.5V.Speaker output turn MUTE immediately, when clock stop protection is detected.

Releasing condition - It will release when MUTEX pin is set High and the BCLK signal returns to the normal clock operation. The speaker output is outputted through a soft-start when released.

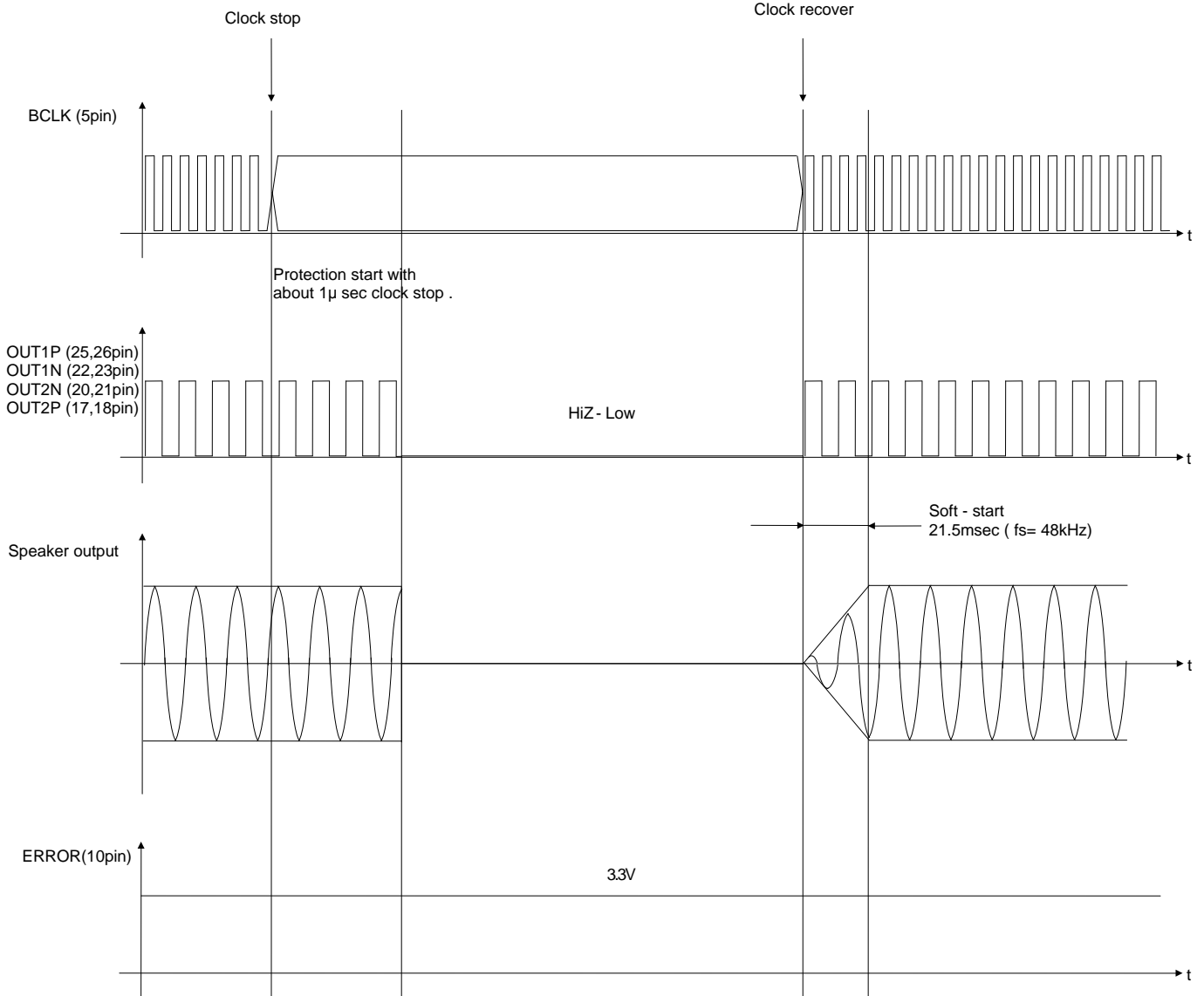

7-3) Clock stop protection (LRCLK)

This IC has the clock stop protection circuit that make the speaker output mute when the LRCLK signal of the digital audio input stops.

Detecting condition - It will detect when MUTEX pin is set High and the LRCLK signal stops for about 21 μ sec (at $f_s=48kHz$) or more. Speaker output turn MUTE immediately, when clock stop protection is detected.

Releasing condition - It will release when MUTEX pin is set High and the LRCLK signal returns to the normal clock operation. The speaker output is outputted through a soft-start when released.

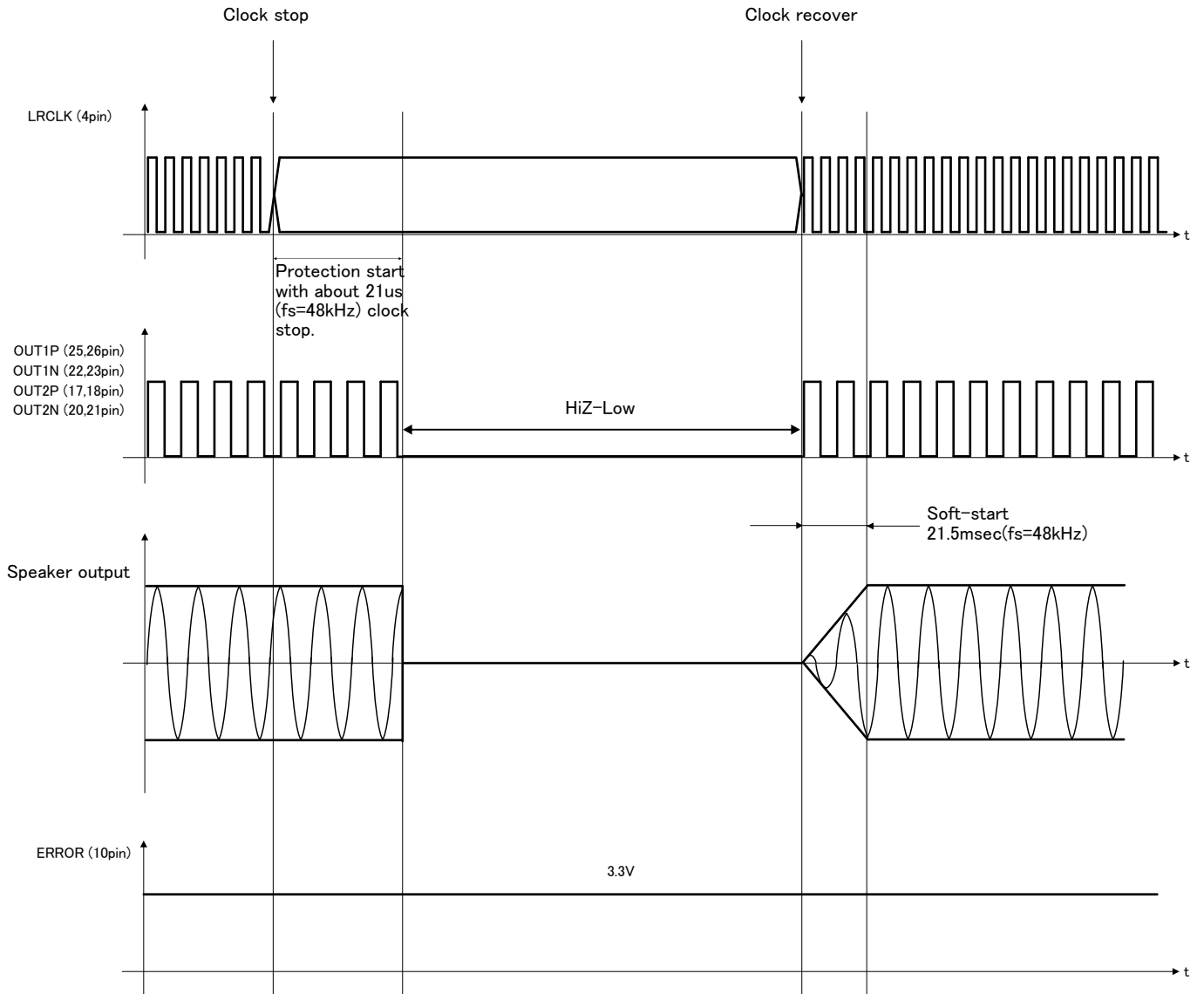

●Application Circuit Example (Stereo BTL Output, $R_L=8\Omega$, $V_{CC}=10V\sim 16V$, $P_o\sim 15W$)

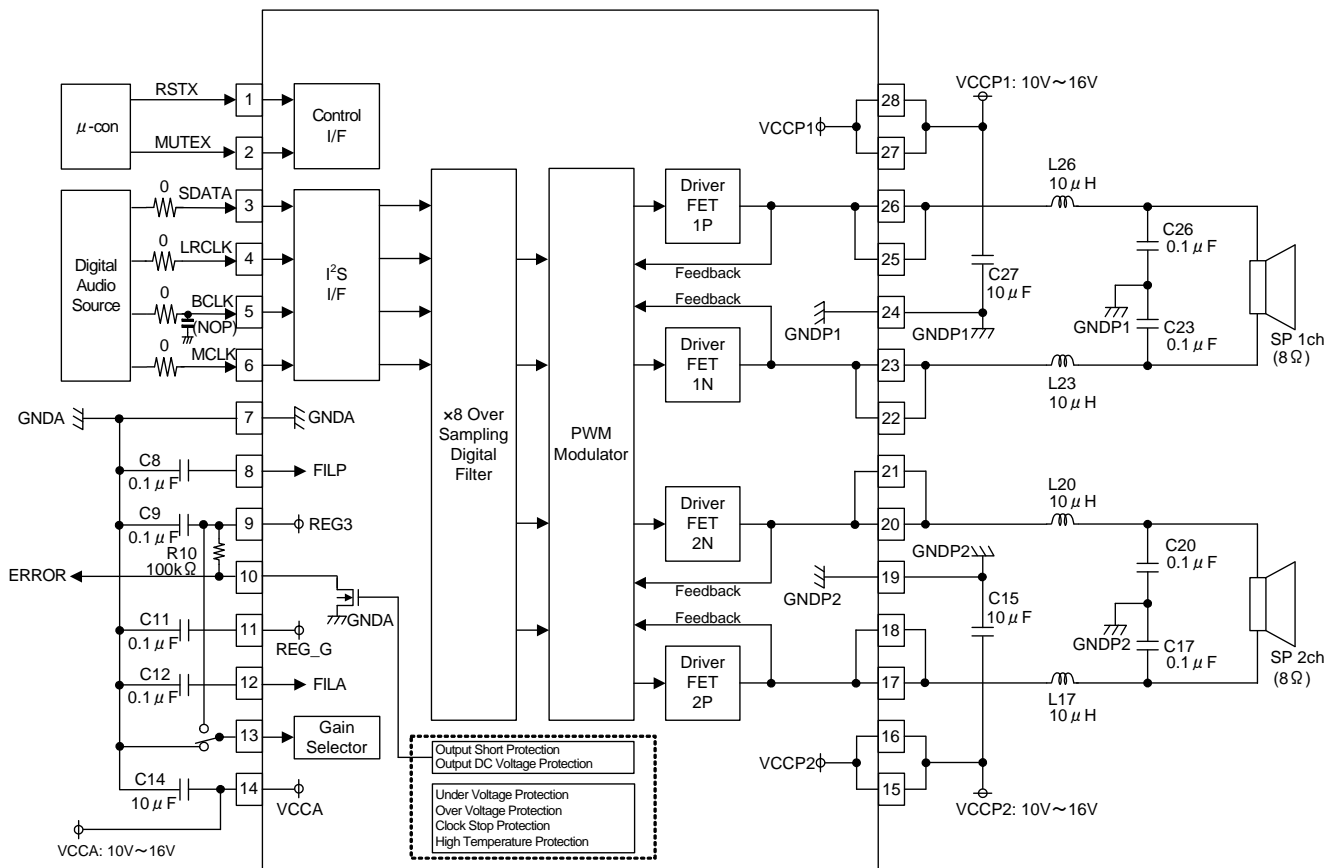

●BOM list (Stereo BTL Output, $R_L=8\Omega$, $V_{CC}=10V\sim 16V$, $P_o\sim 15W$)

Parts	Parts No.	Value	Company	Product No.	Rated Voltage	Tolerance	Size
IC	U1	—	ROHM	BD5451EFV	—	—	9.7mm×6.4mm
Inductor	L17, L20, L23, L26	10μH	TOKO	B1047DS-100M=3P	—	(±20%)	7.6mm×7.6mm
Resistor	R10	100kΩ	ROHM	MCR03EZPJ104	1/10W	J(±1%)	1.6mm×0.8mm
Capacitor	C14, C15, C27	10μF	MURATA	GRM31CB11E106KA75L	25V	B(±10%)	3.2mm×1.6mm
	C8, C9, C11, C12	0.1μF		GRM188B11A104KA92D	10V	B(±10%)	1.6mm×0.8mm
	C17, C20, C23, C26	0.1μF		GRM188B11E104KA01D	25V	B(±10%)	1.6mm×0.8mm

As return of current regenerated by back EMF of output coil happens, take steps such as putting capacitor between power supply and GND as a electric pathway for the regenerated current. Be sure that there is no problem with each property such as emptied capacity at lower temperature regarding electrolytic capacitor to decide capacity value. If the connected power supply does not have sufficient current absorption capacity, regenerative current will cause the voltage on the power supply line to rise, which combined with the product and its peripheral circuitry may exceed the absolute maximum ratings. It is recommended to implement a physical safety measure such as the insertion of a voltage clamp diode between the power supply and GND pins.

●Application Circuit Example (Monaural BTL Output, $R_L=8\Omega$, $V_{CC}=10V\sim 16V$, $P_o\sim 15W$)

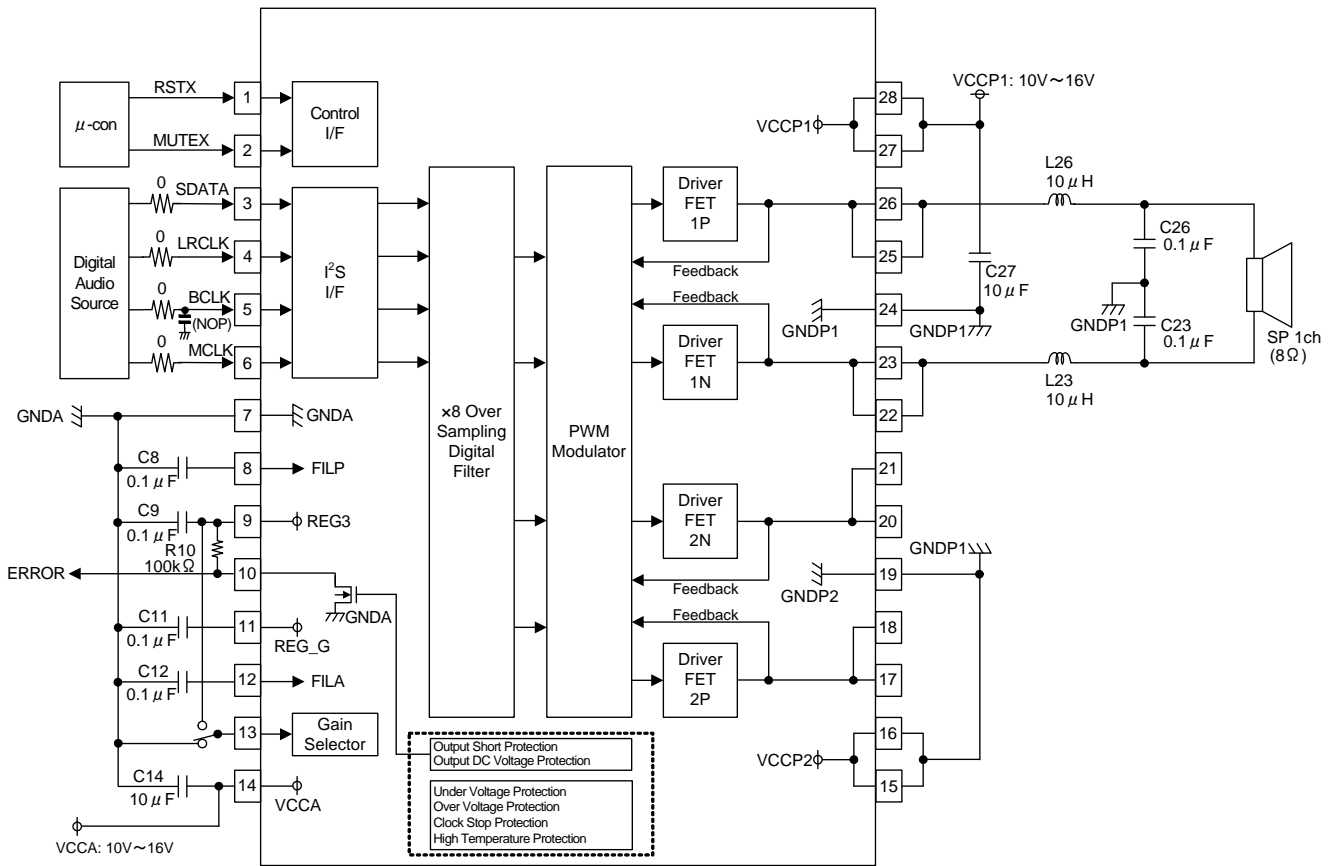

●BOM list (Monaural BTL Output, $R_L=8\Omega$, $V_{CC}=10V\sim 16V$, $P_o\sim 15W$)

Parts	Parts No.	Value	Company	Product No.	Rated Voltage	Tolerance	Size
IC	U1	—	ROHM	BD5451EFV	—	—	9.7mm×6.4mm
Inductor	L23, L26	10μH	TOKO	B1047DS-100M=3P	—	(±20%)	7.6mm×7.6mm
Resistor	R10	100kΩ	ROHM	MCR03EZPJ104	1/10W	F(±1%)	1.6mm×0.8mm
Capacitor	C14, C27	10μF	MURATA	GRM31CB11E106KA75L	25V	B(±10%)	3.2mm×1.6mm
	C8, C9, C11, C12	0.1μF		GRM188B11A104KA92D	10V	B(±10%)	1.6mm×0.8mm
	C23, C26	0.1μF		GRM188B11E104KA01D	25V	B(±10%)	1.6mm×0.8mm

As return of current regenerated by back EMF of output coil happens, take steps such as putting capacitor between power supply and GND as a electric pathway for the regenerated current. Be sure that there is no problem with each property such as emptied capacity at lower temperature regarding electrolytic capacitor to decide capacity value. If the connected power supply does not have sufficient current absorption capacity, regenerative current will cause the voltage on the power supply line to rise, which combined with the product and its peripheral circuitry may exceed the absolute maximum ratings. It is recommended to implement a physical safety measure such as the insertion of a voltage clamp diode between the power supply and GND pins.

●Application Circuit Example (Stereo BTL Output, $R_L=8\Omega$, $V_{CC}=16V\sim 18V$, $P_o\sim 20W$)

※To prevent going over absolute maximum rating by the leap out of power supply and the linking of PWM output wave form, please provide countermeasure shown below diagram (dot-line ※) when using at $V_{CC}>16V$.

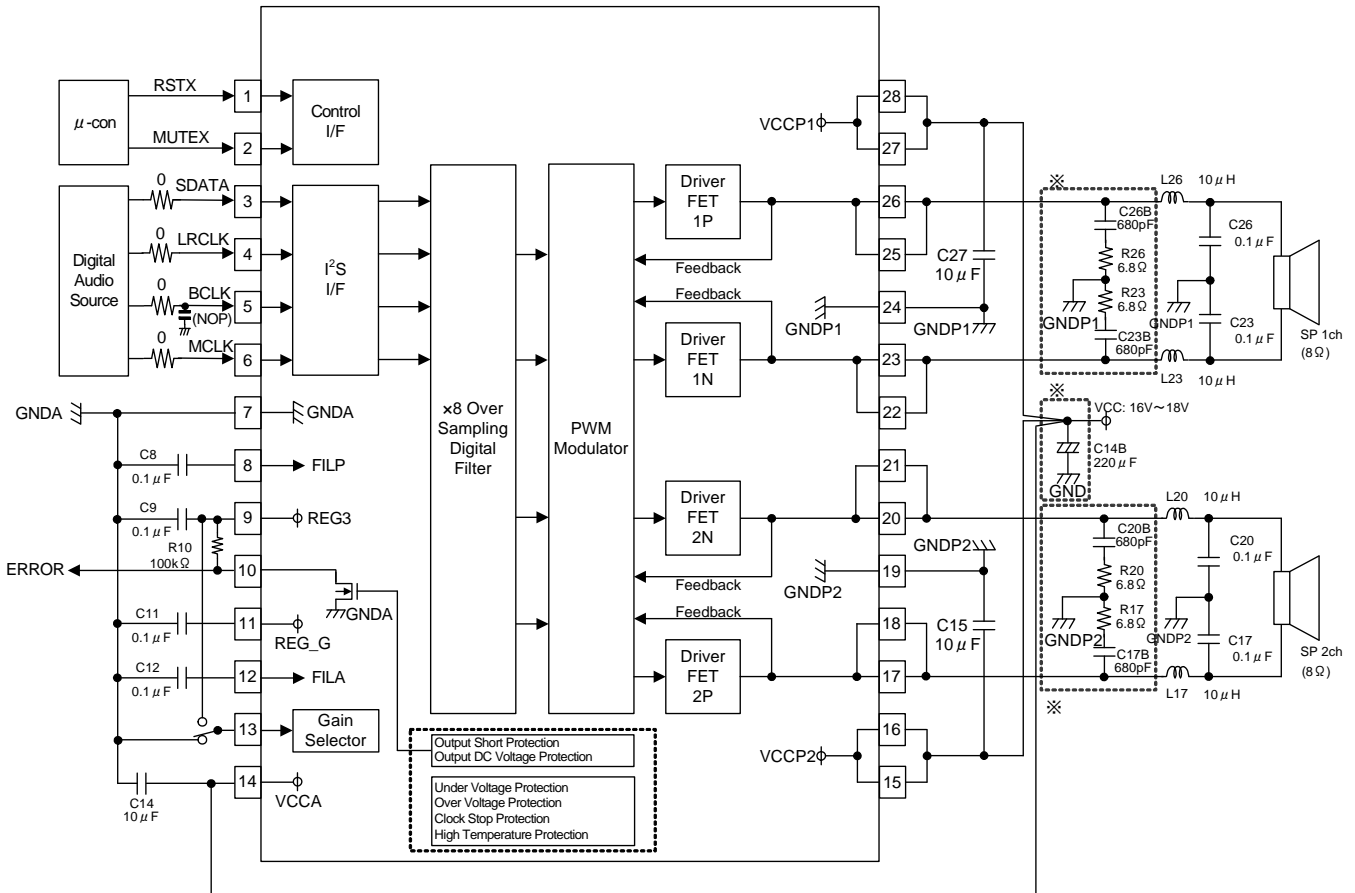

●BOM list (Stereo BTL Output, $R_L=8\Omega$, $V_{CC}=16V\sim 18V$, $P_o\sim 20W$)

Parts	Parts No.	Value	Company	Product No.	Rated Voltage	Tolerance	Size
IC	U1	—	ROHM	BD5451EFV	—	—	9.7mmx6.4mm
Inductor	L17, L20, L23, L26	10µH	TOKO	B1047DS-100M=3P	-	(±20%)	7.6mmx7.6mm
Resistor	R10	100kΩ	ROHM	MCR03EZPJ104	1/10W	J(±5%)	1.6mmx0.8mm
	R17, R20, R23, R26	6.8Ω	ROHM	MCR03EZPFL6R80	1/10W	F(±1%)	1.6mmx0.8mm
Capacitor	C14, C15, C27	10µF	MURATA	GRM31CB11E106KA75L	25V	B(±10%)	3.2mmx1.6mm
	C8, C9, C11, C12	0.1µF		GRM188B11A104KA92D	10V	B(±10%)	1.6mmx0.8mm
	C17, C20, C23, C26	0.1µF		GRM188B11E104KA01D	25V	B(±10%)	1.6mmx0.8mm
	C17,B C20B, C23B, C26B	680pF		GRM188B11E681KA01	25V	B(±10%)	1.6mmx0.8mm
Electrolytic Capacitor	C14B	220µF	Panasonic	ECA1EMH221	25V	±20%	φ8mmx11.5mm

As return of current regenerated by back EMF of output coil happens, take steps such as putting capacitor between power supply and GND as a electric pathway for the regenerated current. Be sure that there is no problem with each property such as emptied capacity at lower temperature regarding electrolytic capacitor to decide capacity value. If the connected power supply does not have sufficient current absorption capacity, regenerative current will cause the voltage on the power supply line to rise, which combined with the product and its peripheral circuitry may exceed the absolute maximum ratings. It is recommended to implement a physical safety measure such as the insertion of a voltage clamp diode between the power supply and GND pins.

●Application Circuit Example (Monaural BTL Output, $R_L=8\Omega$, $V_{CC}=16V\sim 18V$, $P_o\sim 20W$)

※To prevent going over absolute maximum rating by the leap out of power supply and the linking of PWM output wave form, please provide countermeasure shown below diagram (dot-line ※) when using at $V_{CC}>16V$.

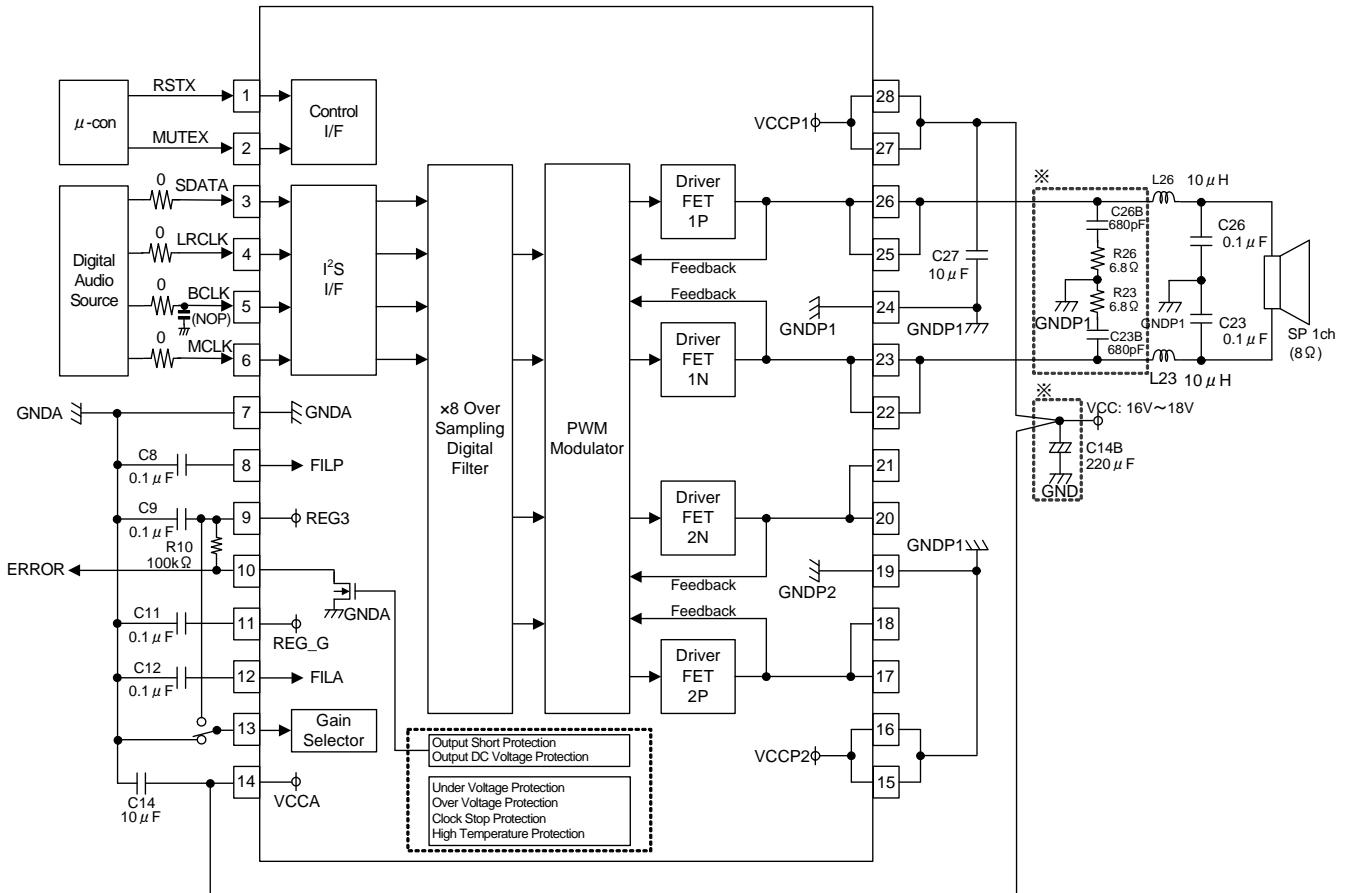

●BOM list (Monaural BTL Output, $R_L=8\Omega$, $V_{CC}=16V\sim 18V$, $P_o\sim 20W$)

Parts	Parts No.	Value	Company	Product No.	Rated Voltage	Tolerance	Size
IC	U1	—	ROHM	BD5451EFV	—	—	9.7mm×6.4mm
Inductor	L23, L26	10μH	TOKO	B1047DS-100M=P3	—	(±20%)	7.6mm×7.6mm
Resistor	R10	100kΩ	ROHM	MCR03EZPJ104	1/10W	J(±5%)	1.6mm×0.8mm
	R23, R26	6.8Ω		MCR03EZPFL6R80	1/10W	F(±1%)	1.6mm×0.8mm
Capacitor	C14, C27	10μF	MURATA	GRM31CB31E106KA75L	25V	B(±10%)	3.2mm×1.6mm
	C8, C9, C11, C12	0.1μF		GRM188B11A104KA92D	10V	B(±10%)	1.6mm×0.8mm
	C23, C26	0.1μF		GRM188B11E104KA01D	25V	B(±10%)	1.6mm×0.8mm
	C23B, C26B	680pF		GRM188B11E681KA01	25V	B(±10%)	1.6mm×0.8mm
Electrolytic Capacitor	C14B	220μF	Panasonic	ECA1EMH221	25V	±20%	φ8mm×11.5mm

As return of current regenerated by back EMF of output coil happens, take steps such as putting capacitor between power supply and GND as a electric pathway for the regenerated current. Be sure that there is no problem with each property such as emptied capacity at lower temperature regarding electrolytic capacitor to decide capacity value. If the connected power supply does not have sufficient current absorption capacity, regenerative current will cause the voltage on the power supply line to rise, which combined with the product and its peripheral circuitry may exceed the absolute maximum ratings. It is recommended to implement a physical safety measure such as the insertion of a voltage clamp diode between the power supply and GND pins.

●Output LC Filter Circuit

An output filter is required to eliminate radio-frequency components exceeding the audio-frequency region supplied to a load (speaker). Because this IC uses sampling clock frequencies from 256kHz ($f_s=32\text{kHz}$) to 384kHz ($f_s=48\text{kHz}$) in the output PWM signals, the high-frequency components must be appropriately removed.

This section takes an example of an LC type LPF shown below, in which coil L and capacitor C compose a differential filter with an attenuation property of -12dB / oct . A large part of switching currents flow to capacitor C, and only a small part of the currents flow to speaker R_L . This filter reduces unwanted emission this way. In addition, coil L and capacitor Cg compose a filter against in-phase components, reducing unwanted emission further.

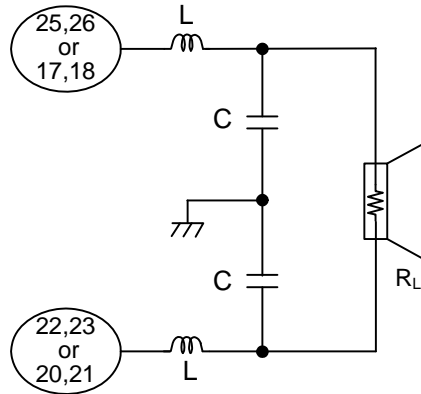

Following presents output LC filter constants with typical load impedances.

R_L	L	C
$4\ \Omega$	$10\ \mu\text{H}$	$0.47\ \mu\text{F}$
$6\ \Omega$	$10\ \mu\text{H}$	$0.15\ \mu\text{F}$
$8\ \Omega$	$10\ \mu\text{H}$	$0.1\ \mu\text{F}$

Use coils with a low direct-current resistance and with a sufficient margin of allowable currents. A high direct-current resistance causes power losses. In addition, select a closed magnetic circuit type product in normal cases to prevent unwanted emission.

Use capacitors with a low equivalent series resistance, and good impedance characteristics at high frequency ranges (100kHz or higher). Also, select an item with sufficient withstand voltage because flowing massive amount of high-frequency currents is expected.

●Notes for use

- 1) Absolute maximum ratings
Use of the IC in excess of absolute maximum ratings such as the applied voltage or operating temperature range may result in IC damage. Assumptions should not be made regarding the state of the IC (short mode or open mode) when such damage is suffered. A physical safety measure such as a fuse should be implemented when use of the IC in a special mode where the absolute maximum ratings may be exceeded is anticipated.
- 2) Power supply lines
As return of current regenerated by back EMF of output coil happens, take steps such as putting capacitor between power supply and GND as a electric pathway for the regenerated current. Be sure that there is no problem with each property such as emptied capacity at lower temperature regarding electrolytic capacitor to decide capacity value. If the connected power supply does not have sufficient current absorption capacity, regenerative current will cause the voltage on the power supply line to rise, which combined with the product and its peripheral circuitry may exceed the absolute maximum ratings. It is recommended to implement a physical safety measure such as the insertion of a voltage clamp diode between the power supply and GND pins.
- 3) GND potential(Pin 7, 19, 24).
Any state must become the lowest voltage about GND terminal and VSS terminal.
- 4) Input terminal
The parasitic elements are formed in the IC because of the voltage relation. The parasitic element operating causes the wrong operation and destruction. Therefore, please be careful so as not to operate the parasitic elements by impressing to input terminals lower voltage than GND and VSS. Please do not apply the voltage to the input terminal when the power-supply voltage is not impressed.
- 5) Setting of heat
Use a thermal design that allows for a sufficient margin in light of the power dissipation (Pd) in actual operating conditions. This IC exposes its frame of the backside of package. Note that this part is assumed to use after providing heat dissipation treatment to improve heat dissipation efficiency. Try to occupy as wide as possible with heat dissipation pattern not only on the board surface but also the backside.
Class D speaker amplifier is high efficiency and low heat generation by comparison with conventional Analog power amplifier. However, In case it is operated continuously by maximum output power, Power dissipation (Pdiss) may exceed package dissipation. Please consider about heat design that Power dissipation (Pdiss) does not exceed Package dissipation (Pd) in average power (Poav). (Tjmax : Maximum junction temperature=150°C, Ta : Peripheral temperature[°C], θja : Thermal resistance of package[°C/W], Poav: Average power[W], η: Efficiency)

$$\text{Package dissipation: } Pd (W) = (T_{jmax} - T_a) / \theta_{ja}$$

$$\text{Power dissipation : } Pdiss(W) = Poav \times (1/\eta - 1)$$
- 6) Actions in strong magnetic field
Use caution when using the IC in the presence of a strong magnetic field as doing so may cause the IC to malfunction.
- 7) Thermal shutdown circuit
This product is provided with a built-in thermal shutdown circuit. When the thermal shutdown circuit operates, the output transistors are placed under open status. The thermal shutdown circuit is primarily intended to shut down the IC avoiding thermal runaway under abnormal conditions with a chip temperature exceeding Tjmax = 150°C.
- 8) Shorts between pins and misinstallation
When mounting the IC on a board, pay adequate attention to orientation and placement discrepancies of the IC. If it is misinstalled and the power is turned on, the IC may be damaged. It also may be damaged if it is shorted by a foreign substance coming between pins of the IC or between a pin and a power supply or a pin and a GND.
- 9) Power supply on/off (Pin 14, 15, 16, 27, 28)
In case power supply is started up, RSTX (Pin 1) and MUTEX (Pin 2) always should be set Low. And in case power supply is shut down, it should be set Low likewise. Then it is possible to eliminate pop noise when power supply is turned on/off. And also, all power supply terminals should start up and shut down together.
- 10) ERROR terminal(Pin 10)
A error flag is outputted when Output short protection and DC voltage protection in the speaker are operated. These flags are the function which the condition of this product is shown in.
- 11) Precautions for Spealer-setting
If the impedance characteristics of the speakers at high-frequency range while increase rapidly, the IC might not have stable-operation in the resonance frequency range of the LC-filter. Therefore, consider adding damping-circuit, etc., depending on the impedance of the speaker.
- 12) Notes about the phase of MCLK (Pin6) and BCLK (Pin5)
If the rising edge of MCLK (Pin6) and BCLK (Pin5) becomes simultaneous, noise or sound shutdown may occur. Please cope with it, when the rising edge of MCLK and BCLK becomes simultaneous. (Example: Insert RC filter in BCLK)

●Package outline (HTSSOP-B28)

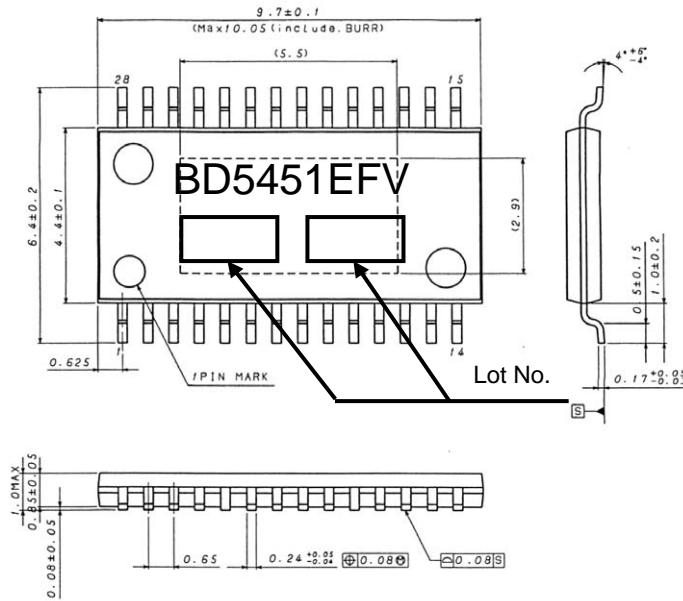

(UNIT: mm)
 PKG: HTSSOP-B28
 Drawing No: EX199-5002-1

●Allowable Power Dissipation

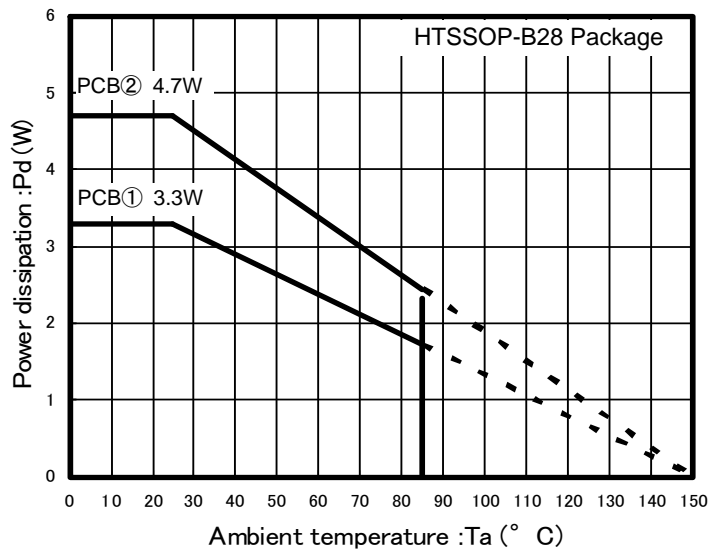

Measuring instrument: TH-156(Shibukawa Kuwano Electrical Instruments Co., Ltd.)

Measuring conditions: Installation on ROHM's board

Board size: 70mm×70mm×1.6mm(with thermal via on board)

Material: FR4

• The board on exposed heat sink on the back of package are connected by soldering.

PCB①: 2-layer board(back copper foil size: 70mm×70mm), $\theta_{ja}=37.9^{\circ}\text{C/W}$

PCB②: 4-layer board(back copper foil size: 70mm×70mm), $\theta_{ja}=26.6^{\circ}\text{C/W}$

●Ordering part number

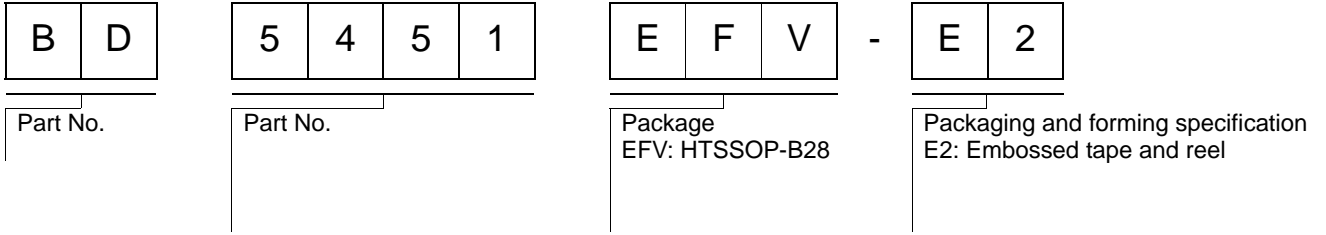

HTSSOP-B28

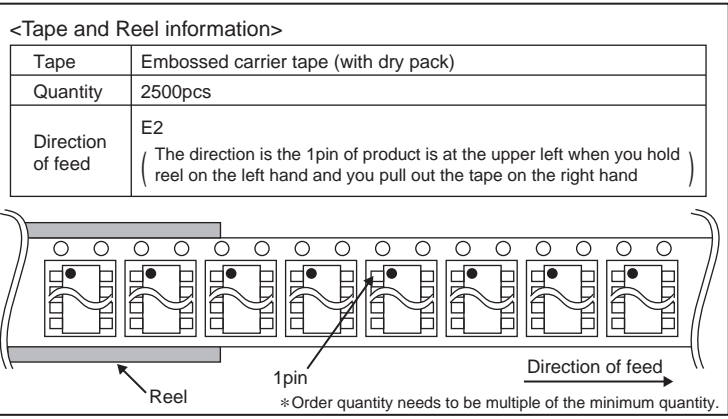
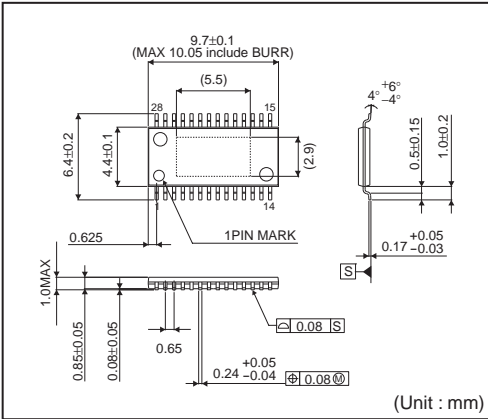

Notice

Precaution on using ROHM Products

- Our Products are designed and manufactured for application in ordinary electronic equipments (such as AV equipment, OA equipment, telecommunication equipment, home electronic appliances, amusement equipment, etc.). If you intend to use our Products in devices requiring extremely high reliability (such as medical equipment ^(Note 1), transport equipment, traffic equipment, aircraft/spacecraft, nuclear power controllers, fuel controllers, car equipment including car accessories, safety devices, etc.) and whose malfunction or failure may cause loss of human life, bodily injury or serious damage to property ("Specific Applications"), please consult with the ROHM sales representative in advance. Unless otherwise agreed in writing by ROHM in advance, ROHM shall not be in any way responsible or liable for any damages, expenses or losses incurred by you or third parties arising from the use of any ROHM's Products for Specific Applications.

(Note1) Medical Equipment Classification of the Specific Applications

JAPAN	USA	EU	CHINA
CLASS III	CLASS III	CLASS II b	CLASS III
CLASS IV		CLASS III	

- ROHM designs and manufactures its Products subject to strict quality control system. However, semiconductor products can fail or malfunction at a certain rate. Please be sure to implement, at your own responsibilities, adequate safety measures including but not limited to fail-safe design against the physical injury, damage to any property, which a failure or malfunction of our Products may cause. The following are examples of safety measures:
 - Installation of protection circuits or other protective devices to improve system safety
 - Installation of redundant circuits to reduce the impact of single or multiple circuit failure
- Our Products are designed and manufactured for use under standard conditions and not under any special or extraordinary environments or conditions, as exemplified below. Accordingly, ROHM shall not be in any way responsible or liable for any damages, expenses or losses arising from the use of any ROHM's Products under any special or extraordinary environments or conditions. If you intend to use our Products under any special or extraordinary environments or conditions (as exemplified below), your independent verification and confirmation of product performance, reliability, etc. prior to use, must be necessary:
 - Use of our Products in any types of liquid, including water, oils, chemicals, and organic solvents
 - Use of our Products outdoors or in places where the Products are exposed to direct sunlight or dust
 - Use of our Products in places where the Products are exposed to sea wind or corrosive gases, including Cl₂, H₂S, NH₃, SO₂, and NO₂
 - Use of our Products in places where the Products are exposed to static electricity or electromagnetic waves
 - Use of our Products in proximity to heat-producing components, plastic cords, or other flammable items
 - Sealing or coating our Products with resin or other coating materials
 - Use of our Products without cleaning residue of flux (even if you use no-clean type fluxes, cleaning residue of flux is recommended); or Washing our Products by using water or water-soluble cleaning agents for cleaning residue after soldering
 - Use of the Products in places subject to dew condensation
- The Products are not subject to radiation-proof design.
- Please verify and confirm characteristics of the final or mounted products in using the Products.
- In particular, if a transient load (a large amount of load applied in a short period of time, such as pulse. is applied, confirmation of performance characteristics after on-board mounting is strongly recommended. Avoid applying power exceeding normal rated power; exceeding the power rating under steady-state loading condition may negatively affect product performance and reliability.
- De-rate Power Dissipation (Pd) depending on Ambient temperature (Ta). When used in sealed area, confirm the actual ambient temperature.
- Confirm that operation temperature is within the specified range described in the product specification.
- ROHM shall not be in any way responsible or liable for failure induced under deviant condition from what is defined in this document.

Precaution for Mounting / Circuit board design

- When a highly active halogenous (chlorine, bromine, etc.) flux is used, the residue of flux may negatively affect product performance and reliability.
- In principle, the reflow soldering method must be used; if flow soldering method is preferred, please consult with the ROHM representative in advance.

For details, please refer to ROHM Mounting specification

Precautions Regarding Application Examples and External Circuits

1. If change is made to the constant of an external circuit, please allow a sufficient margin considering variations of the characteristics of the Products and external components, including transient characteristics, as well as static characteristics.
2. You agree that application notes, reference designs, and associated data and information contained in this document are presented only as guidance for Products use. Therefore, in case you use such information, you are solely responsible for it and you must exercise your own independent verification and judgment in the use of such information contained in this document. ROHM shall not be in any way responsible or liable for any damages, expenses or losses incurred by you or third parties arising from the use of such information.

Precaution for Electrostatic

This Product is electrostatic sensitive product, which may be damaged due to electrostatic discharge. Please take proper caution in your manufacturing process and storage so that voltage exceeding the Products maximum rating will not be applied to Products. Please take special care under dry condition (e.g. Grounding of human body / equipment / solder iron, isolation from charged objects, setting of ionizer, friction prevention and temperature / humidity control).

Precaution for Storage / Transportation

1. Product performance and soldered connections may deteriorate if the Products are stored in the places where:
 - [a] the Products are exposed to sea winds or corrosive gases, including Cl₂, H₂S, NH₃, SO₂, and NO₂
 - [b] the temperature or humidity exceeds those recommended by ROHM
 - [c] the Products are exposed to direct sunshine or condensation
 - [d] the Products are exposed to high Electrostatic
2. Even under ROHM recommended storage condition, solderability of products out of recommended storage time period may be degraded. It is strongly recommended to confirm solderability before using Products of which storage time is exceeding the recommended storage time period.
3. Store / transport cartons in the correct direction, which is indicated on a carton with a symbol. Otherwise bent leads may occur due to excessive stress applied when dropping of a carton.
4. Use Products within the specified time after opening a humidity barrier bag. Baking is required before using Products of which storage time is exceeding the recommended storage time period.

Precaution for Product Label

QR code printed on ROHM Products label is for ROHM's internal use only.

Precaution for Disposition

When disposing Products please dispose them properly using an authorized industry waste company.

Precaution for Foreign Exchange and Foreign Trade act

Since our Products might fall under controlled goods prescribed by the applicable foreign exchange and foreign trade act, please consult with ROHM representative in case of export.

Precaution Regarding Intellectual Property Rights

1. All information and data including but not limited to application example contained in this document is for reference only. ROHM does not warrant that foregoing information or data will not infringe any intellectual property rights or any other rights of any third party regarding such information or data. ROHM shall not be in any way responsible or liable for infringement of any intellectual property rights or other damages arising from use of such information or data.:
2. No license, expressly or implied, is granted hereby under any intellectual property rights or other rights of ROHM or any third parties with respect to the information contained in this document.

Other Precaution

1. This document may not be reprinted or reproduced, in whole or in part, without prior written consent of ROHM.
2. The Products may not be disassembled, converted, modified, reproduced or otherwise changed without prior written consent of ROHM.
3. In no event shall you use in any way whatsoever the Products and the related technical information contained in the Products or this document for any military purposes, including but not limited to, the development of mass-destruction weapons.
4. The proper names of companies or products described in this document are trademarks or registered trademarks of ROHM, its affiliated companies or third parties.

General Precaution

1. Before you use our Products, you are requested to carefully read this document and fully understand its contents. ROHM shall not be in any way responsible or liable for failure, malfunction or accident arising from the use of any ROHM's Products against warning, caution or note contained in this document.
2. All information contained in this document is current as of the issuing date and subject to change without any prior notice. Before purchasing or using ROHM's Products, please confirm the latest information with a ROHM sales representative.
3. The information contained in this document is provided on an "as is" basis and ROHM does not warrant that all information contained in this document is accurate and/or error-free. ROHM shall not be in any way responsible or liable for any damages, expenses or losses incurred by you or third parties resulting from inaccuracy or errors of or concerning such information.