



TL.01.1F11
on ground plane



Underside of TL.01.1F11
with N type (M) connector



Shockwave

TL.01.1F11

Specification

Part No.	TL.01.1F11
Product Name	Shockwave Ultra-Wideband Direct Mount antenna Covers all common 2G/3G/4G Cellular - ISM- Wi-Fi Bands
Feature	LTE / GSM / CDMA /DCS /PCS / WCDMA / UMTS / HSDPA / GPRS / EDGE /GPS /Wi-Fi 698MHz to 960MHz, 1575.42MHz, 1710MHz to 2700Mhz, Highest Efficiency and Peak Gain –up to 90% IP67 Waterproof and IP69K N type (M) Connector RoHS Compliant



1. Introduction

The Shockwave TL.01 series is a new generation of antenna, one part number that is a highly efficient, high gain omni-directional permanent mount antenna designed for all common Cellular, Wi-Fi and ISM bands worldwide. It is specially designed for easy and cost effective vandal-proof and waterproof mounting requirements on meters, terminal boxes, and heavy equipment and vehicles.

In installation the antenna connects to a N female connector jutting out from a metal panel. A unique indent tab on the base itself on the antenna allows a wrench to be used to solidly lock the antenna on top

of it's mounting location, thus preventing removal by hand later by vandals, but crucially allowing for replacement antenna to be installed by qualified personnel in the future without the need to open the device or box it is mounted on itself. A waterproof O-ring around the bottom outer edge prevents water leaking under the antenna.

The antenna is IP67 waterproof and IP69K resistant against high pressure water jets in commercial cleaning environments, incorporating highest quality stainless steel mounting base ensuring corrosion resistance.

The Shockwave TL.01 has been tested on a variety of mounting conditions as below specification, with excellent efficiency and gain measured in all typical common mounting conditions. Radiation patterns are consistent, and show very good stability in the azimuth on lower and upper bands.

Housing, frequency application, mounting type and connector are customizable, subject to minimum order quantities. Please contact your local Taoglas sales office for more information. The antenna also comes in White as standard.

2. Specification

Electrical

Frequency (MHz)	698~800	824~960	1575.42	1710 ~ 1880	1850 ~ 1990	1710 ~ 2170	2400~2700
Peak Gain (dBi)							
Free Space	-1.7	-0.9	0.8	1.3	1.3	1.7	3.5
10x10cm GP center	-1.3	0.1	0.3	0.1	0.4	0.5	2.3
30x30cm GP center	2.7	2.5	1.0	2.2	2.1	2.2	3.1
50x50cm GP center	2.6	2.5	1.2	3.1	3.2	3.1	2.8
Average Gain (dBi)							
Free Space	-6.6	-5.1	-1.8	-1.5	-1.5	-1.3	-0.9
10x10cm GP center	-3.1	-1.9	-1.9	-2.1	-2.0	-1.9	-1.4
30x30cm GP center	-0.4	-1.1	-1.6	-1.7	-1.3	-1.3	-1.6
50x50cm GP center	-0.3	-1.0	-1.6	-1.2	-0.8	-0.9	-1.6
Efficiency							
Free Space	22%	31%	64%	69%	69%	72%	80%
10x10cm GP center	48%	63%	63%	60%	63%	63%	71%
30x30cm GP center	90%	76%	67%	67%	73%	73%	69%
50x50cm GP center	91%	78%	68%	75%	83%	81%	68%
Impedance	50Ω						
Polarization	Vertical						
Radiation Pattern	Omni						

Mechanical

Casing	PC+PBT
Connector	N Type Male
Base	Stainless Steel

Environmental

Temperature Range	-40°C to 85°C
Humidity	Non-condensing 65°C 95% RH

3. Antenna Characteristics

3.1 Return Loss

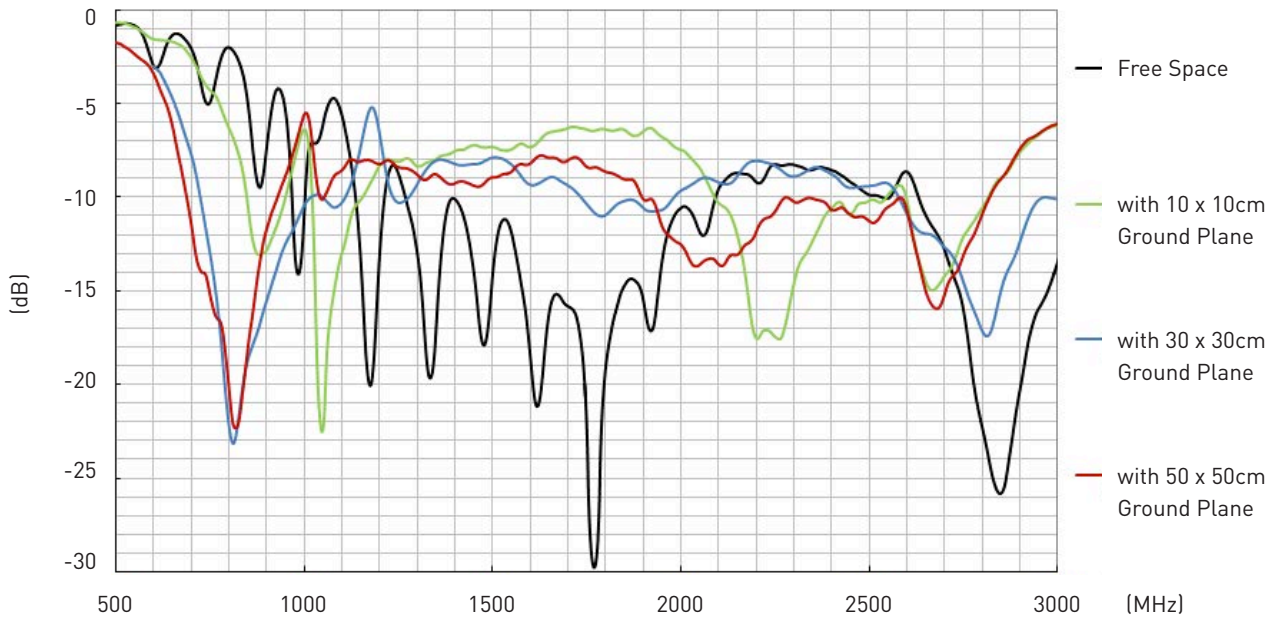

3.2 Maximum Gain

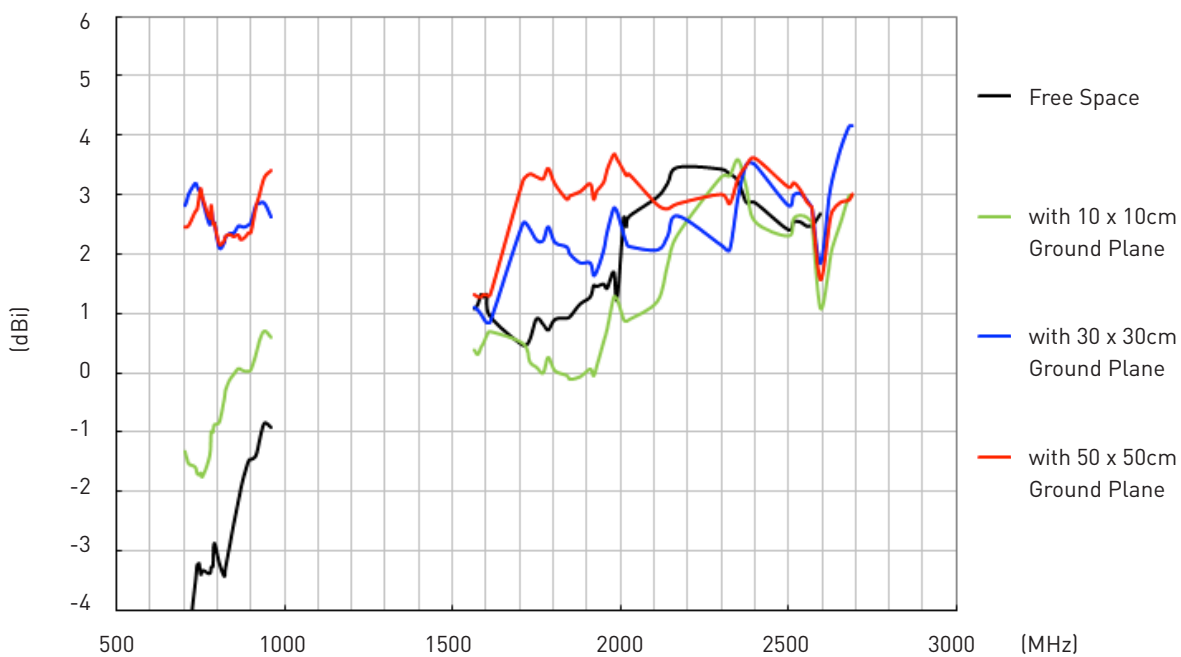

3. Antenna Characteristics

3.3 Average Gain

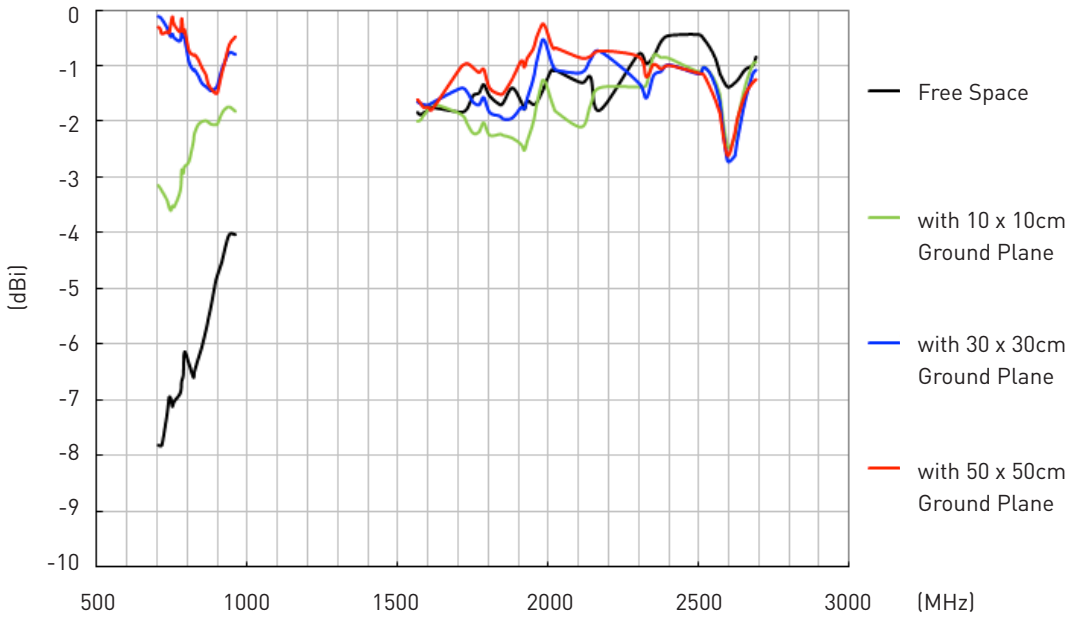

3.4 Efficiency

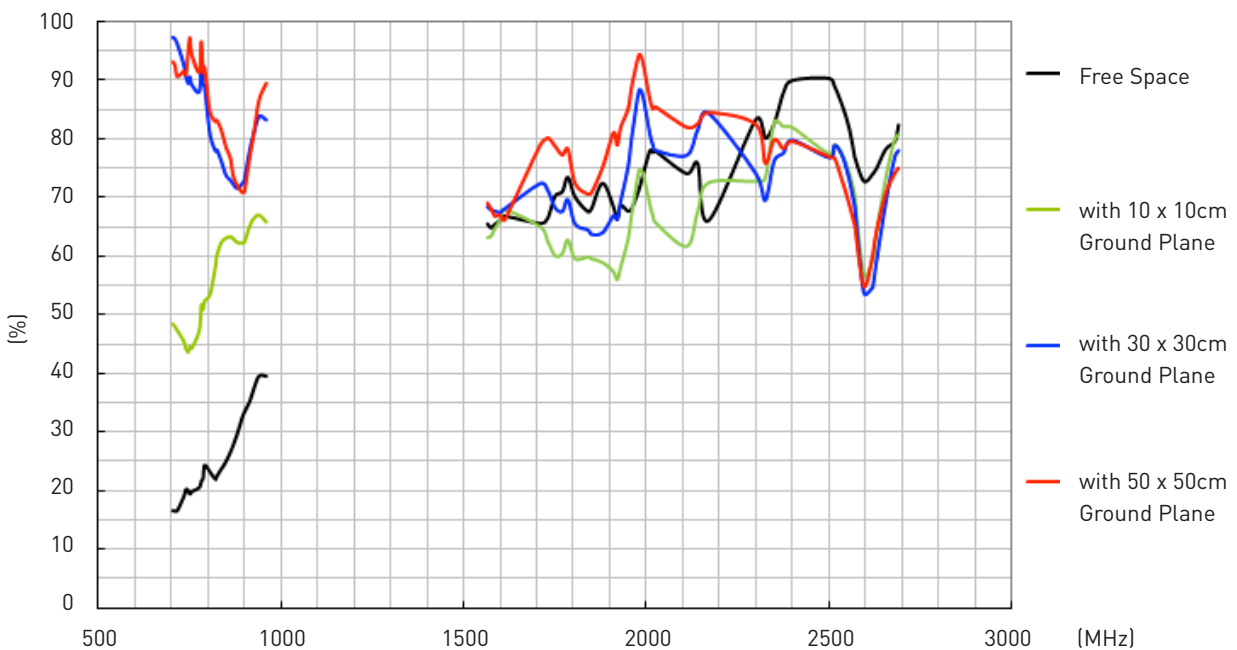

4. Antenna Radiation Patterns

4.1 Antenna Setup (Free Space)

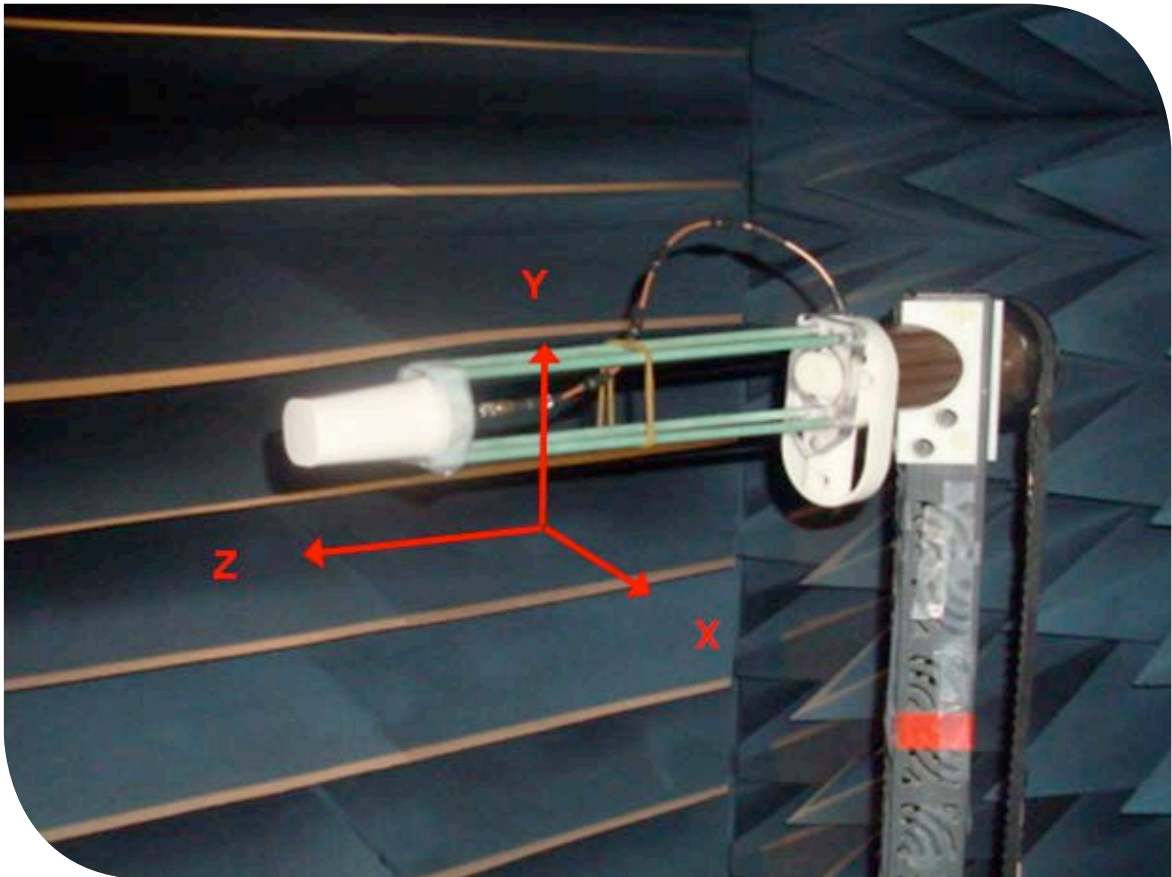

4.1.1 Radiation Patterns

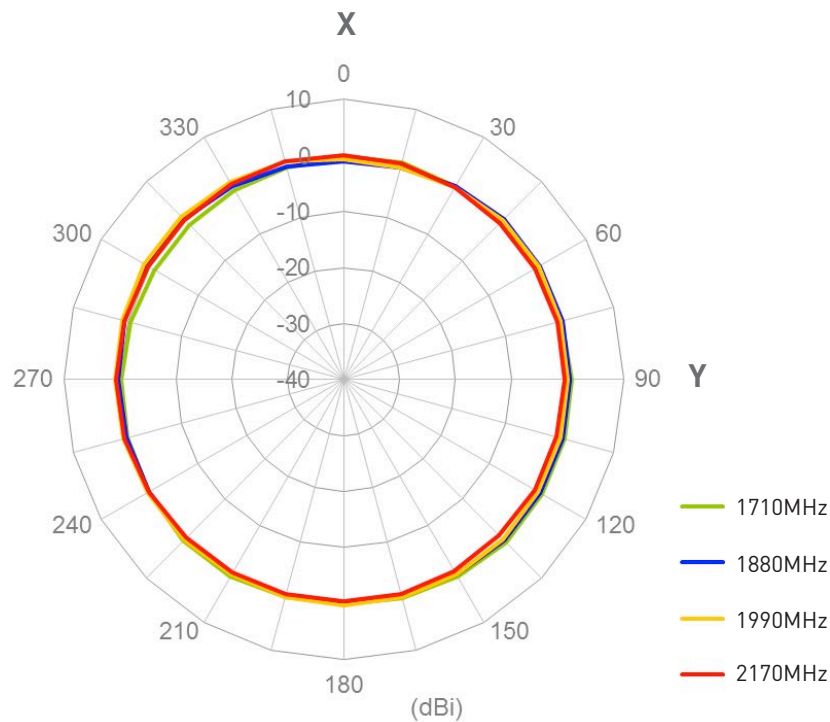
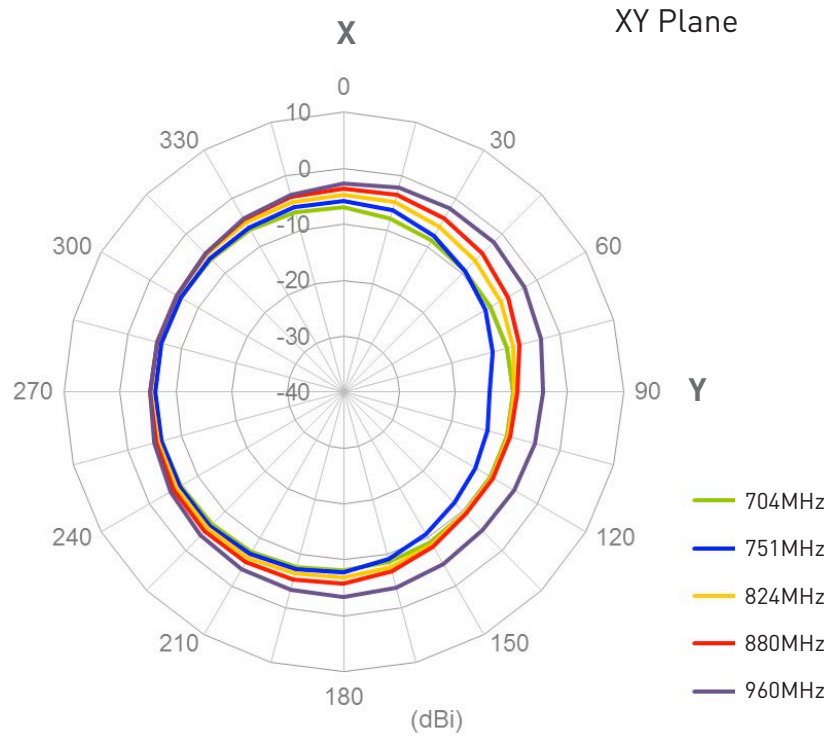

4.1.1 Radiation Patterns

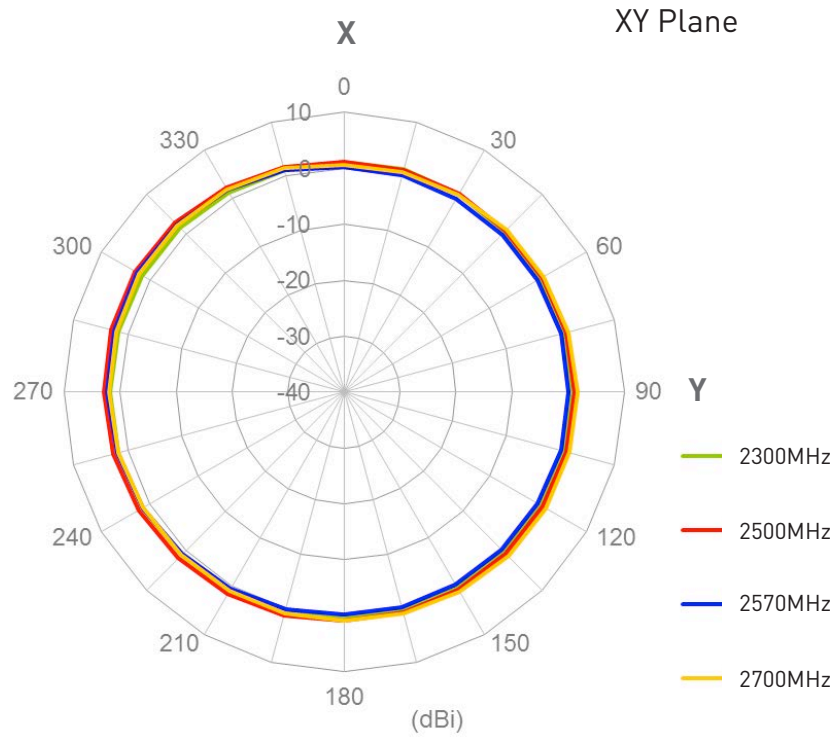

4.1.1 Radiation Patterns

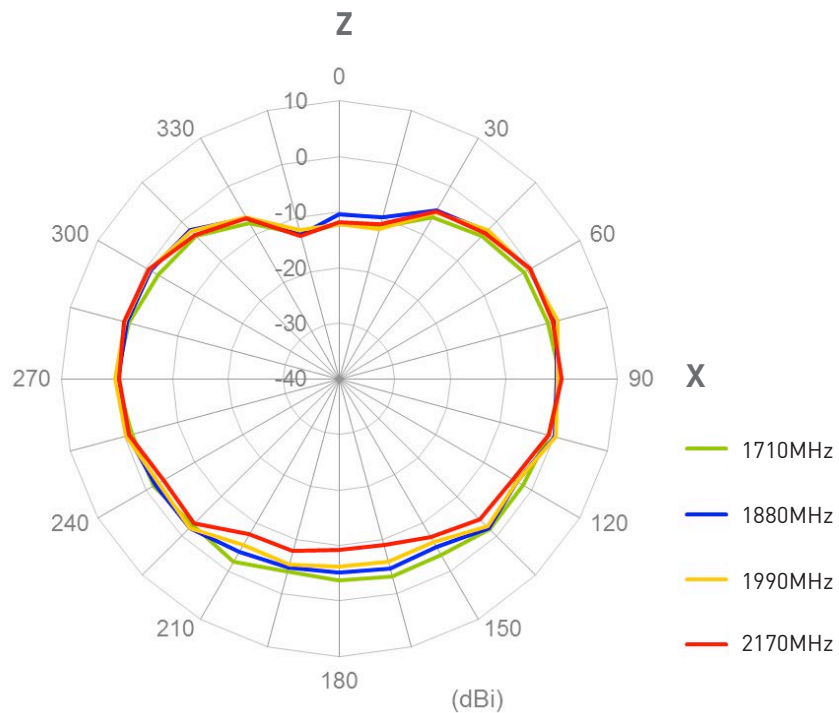
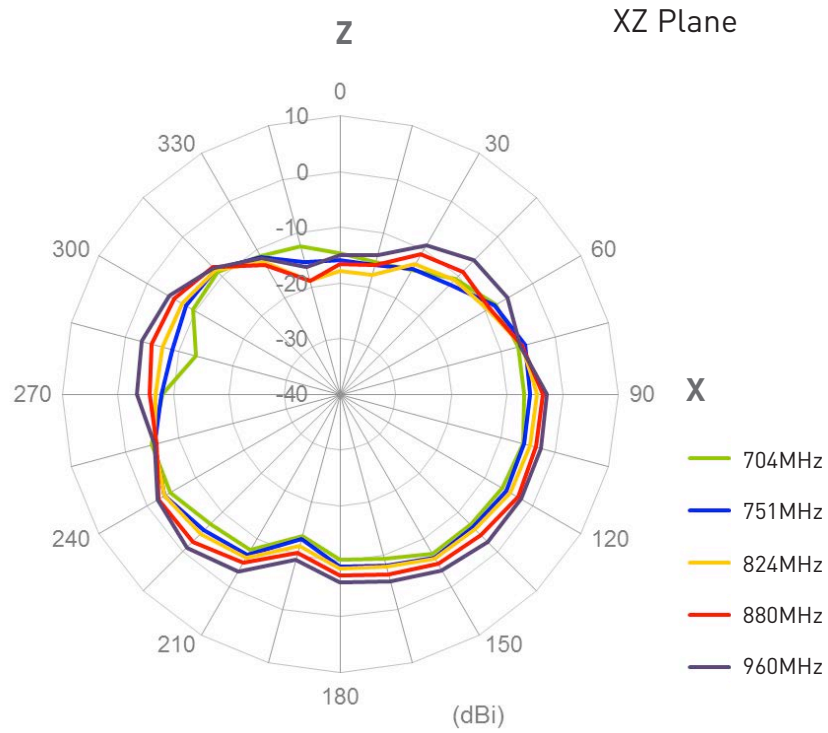

4.1.1 Radiation Patterns

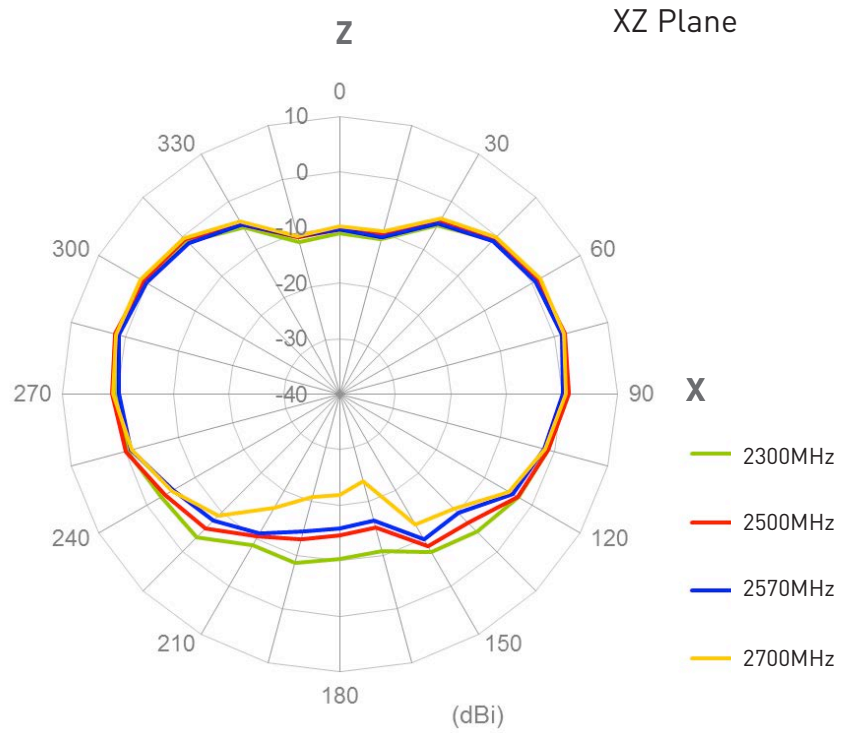

4.2 Antenna Setup (10 x 10cm Metal Ground Plane)

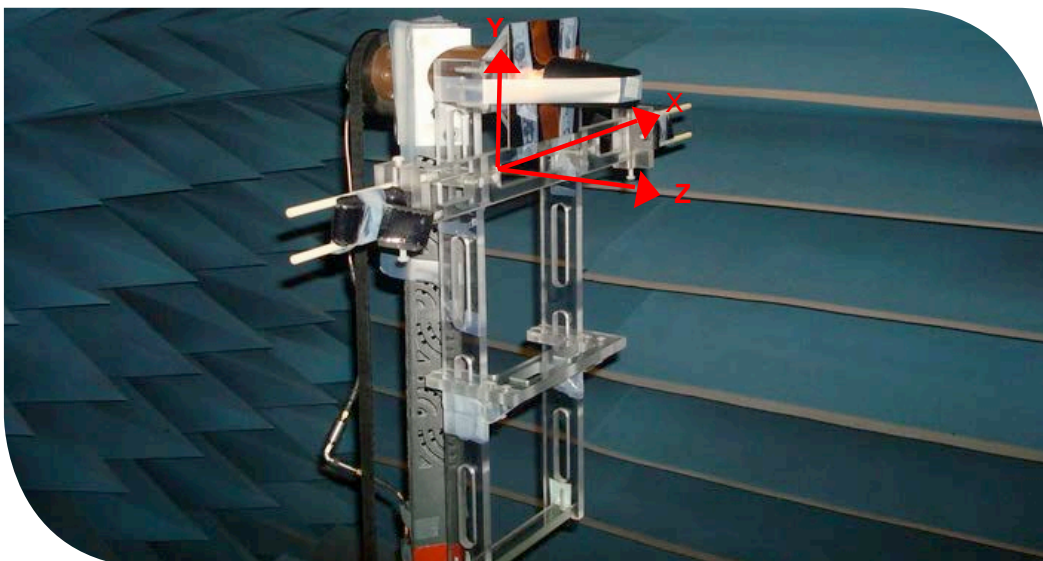

4.2.1 Radiation Patterns

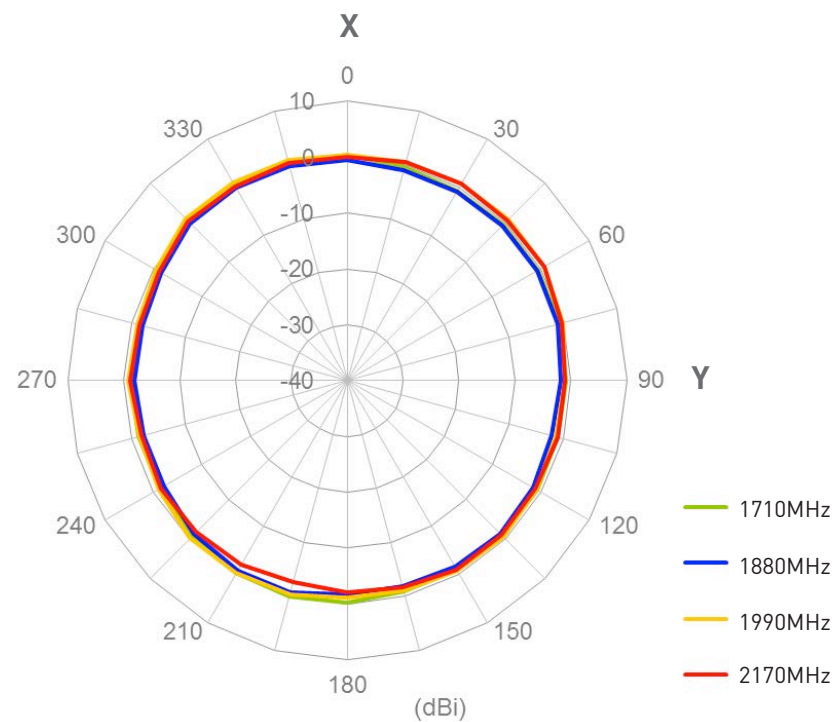
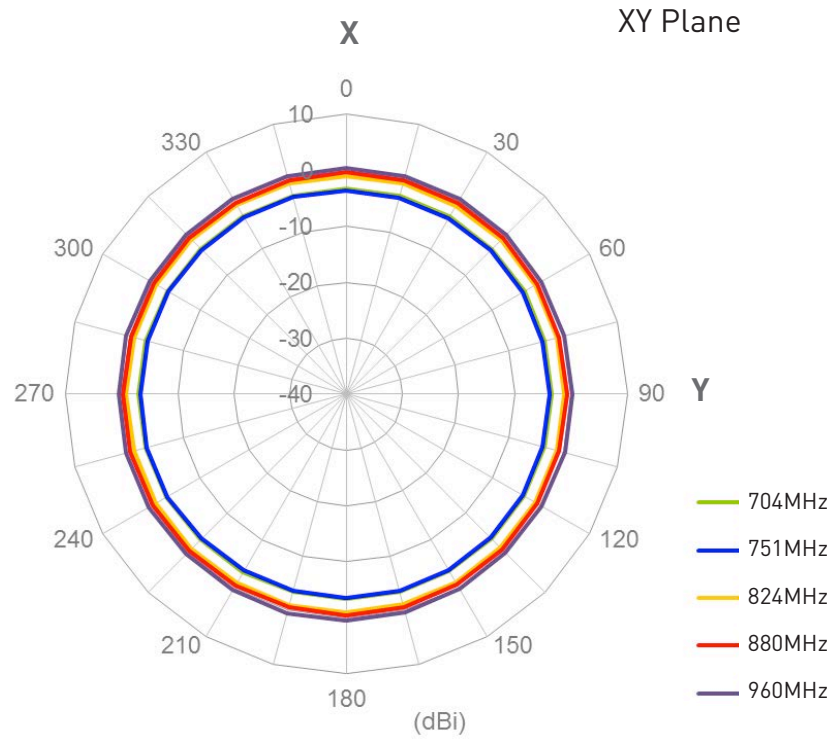

4.2.1 Radiation Patterns

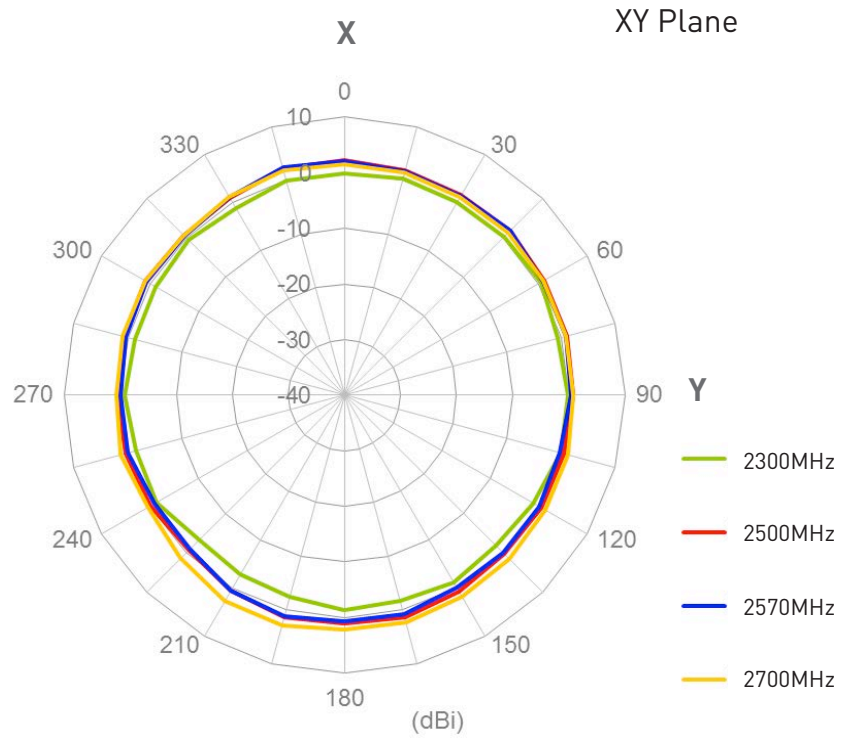

4.2.1 Radiation Patterns

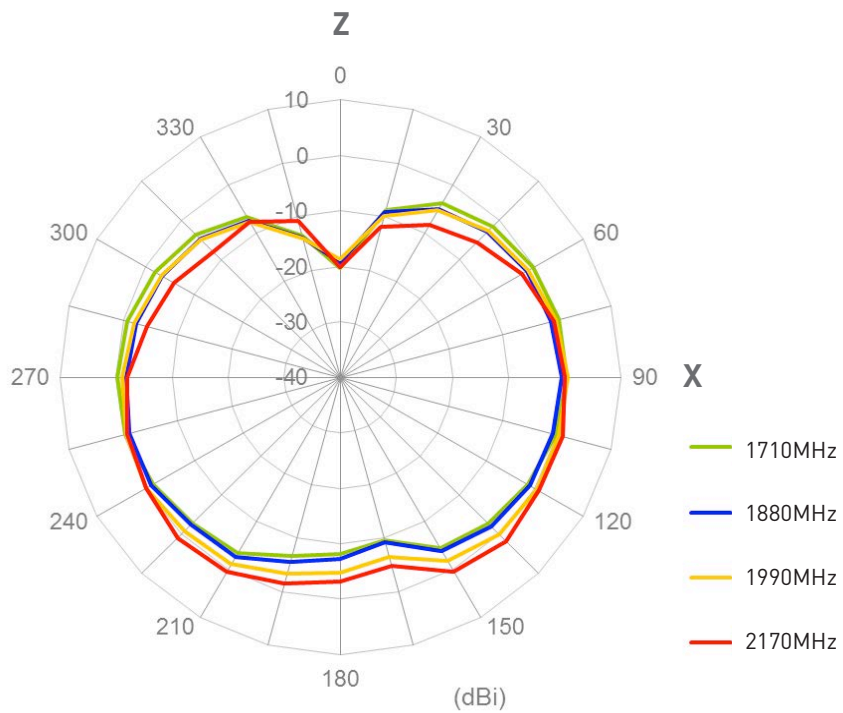
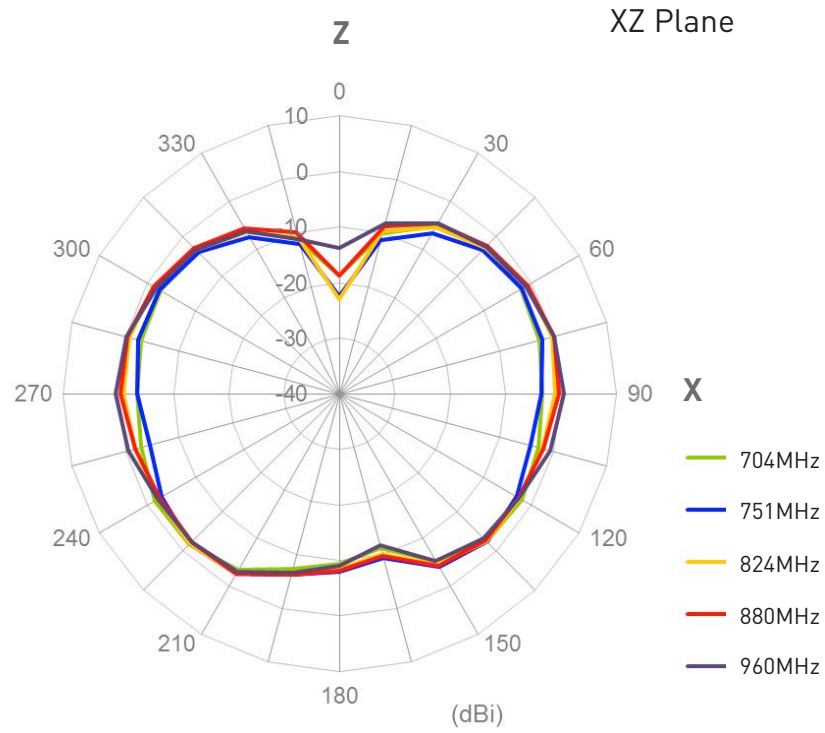

4.2 .1 Radiation Patterns

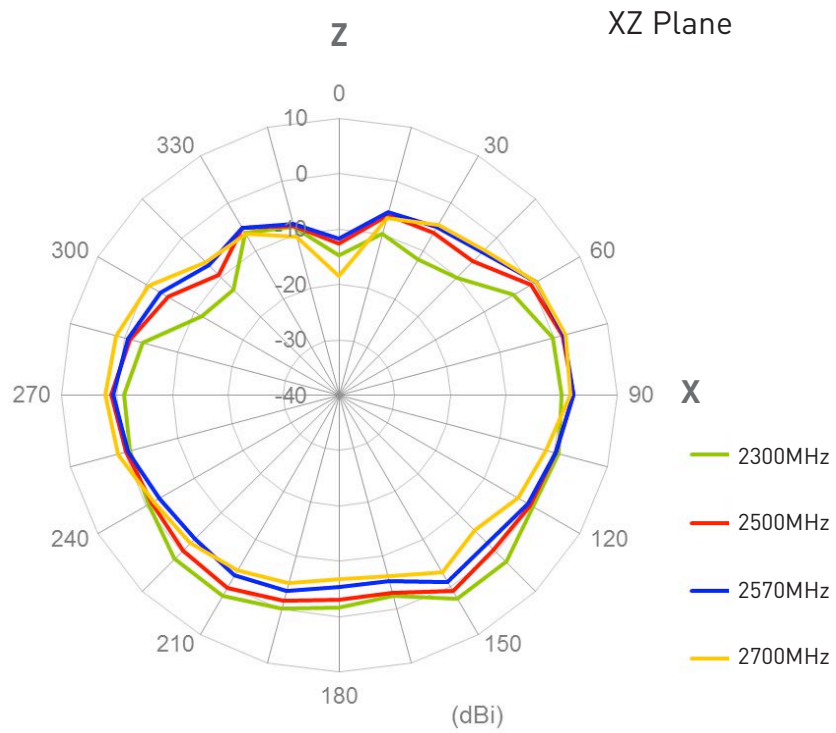

4.3 Antenna Setup (30 x 30cm Metal Ground Plane)

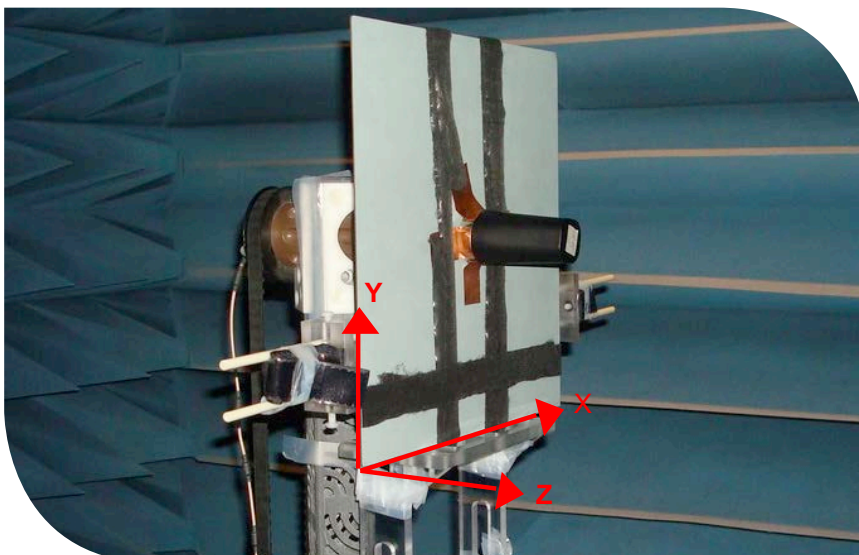

4.3.1 Radiation Patterns

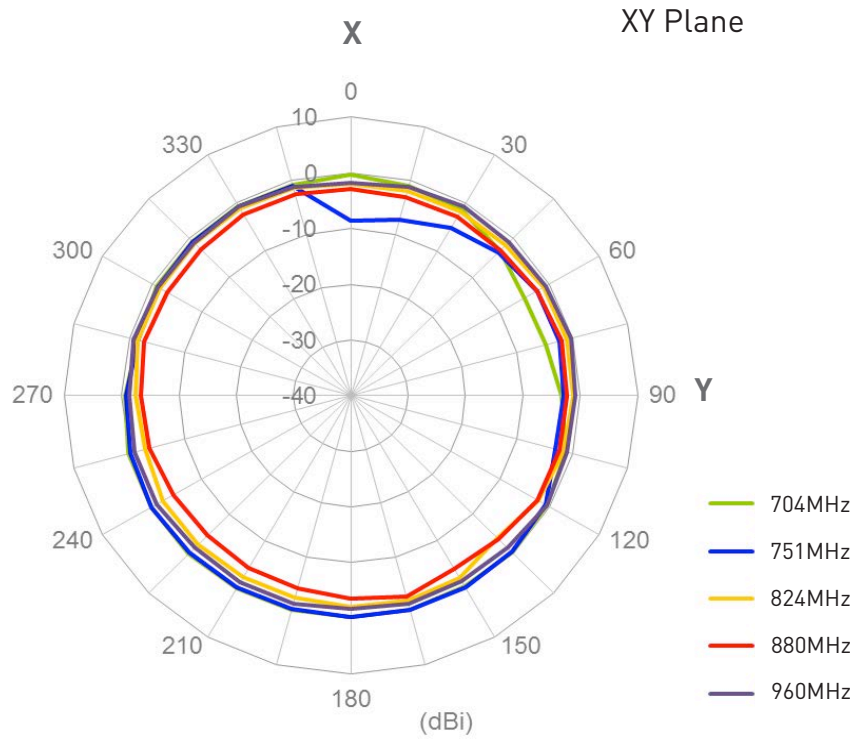

4.2.1 Radiation Patterns

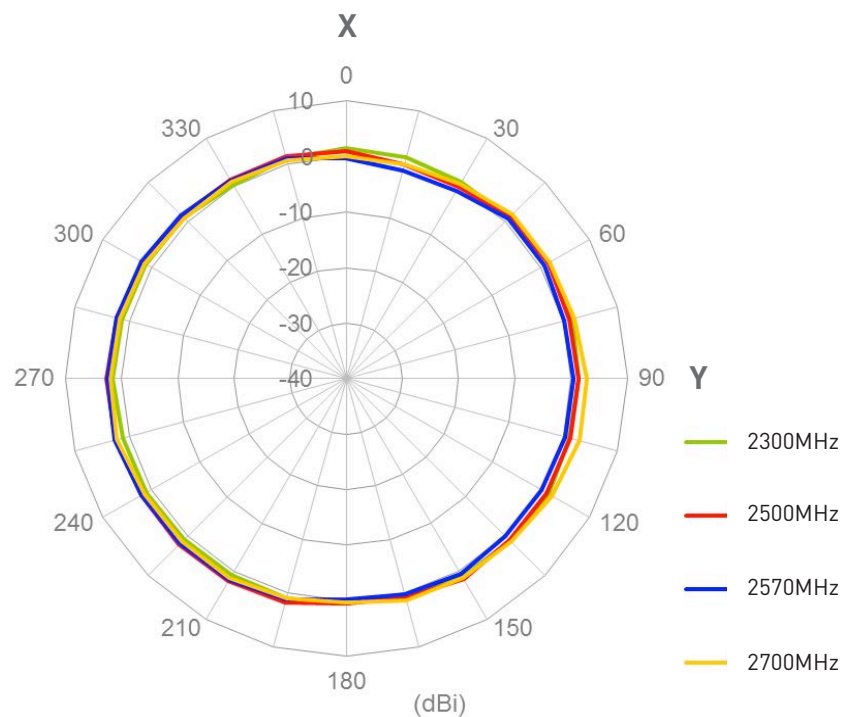
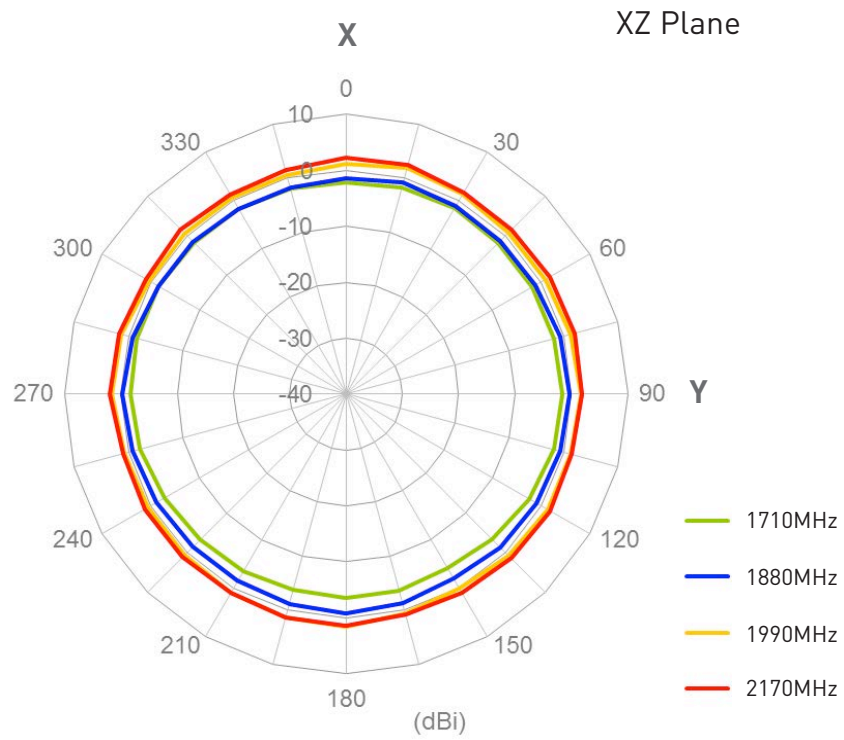

4.2.1 Radiation Patterns

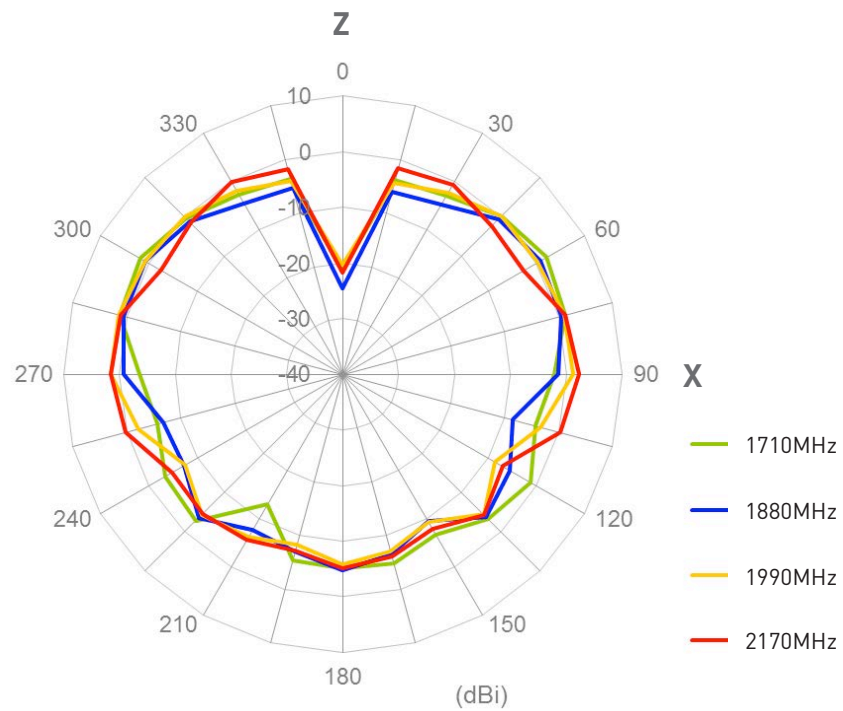
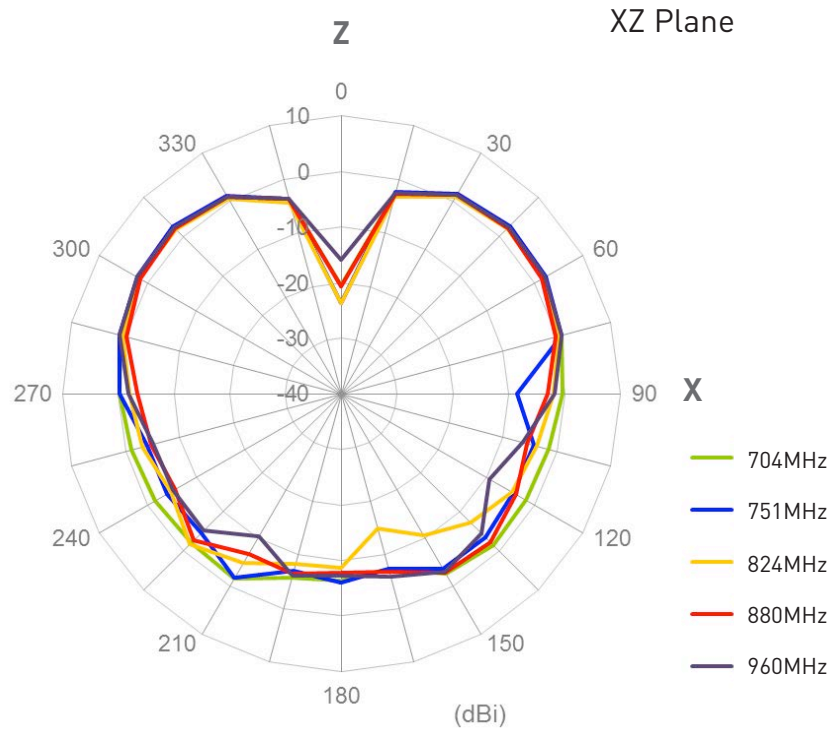

4.3.1 Radiation Patterns

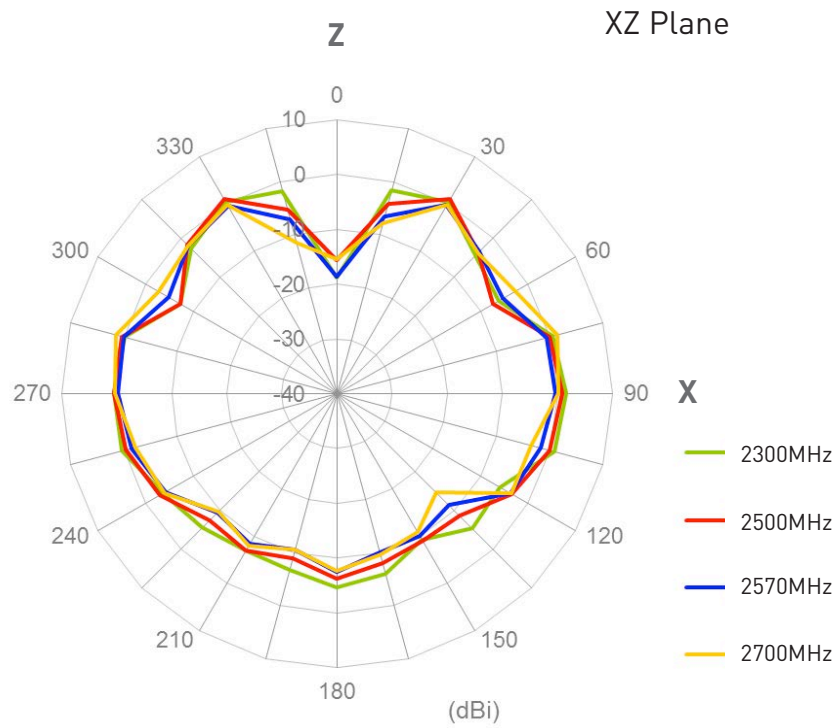

4.4 Antenna Setup (50 x 50cm Metal Ground Plane)

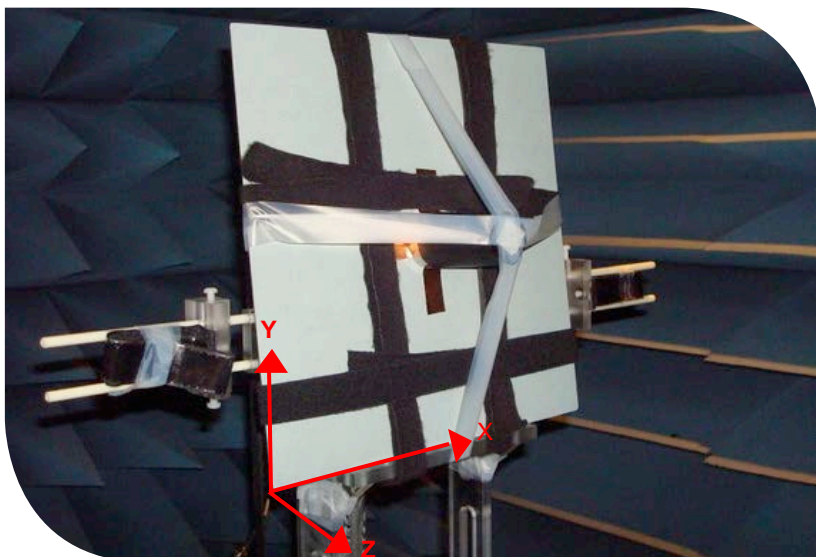

4.4.1 Radiation Patterns

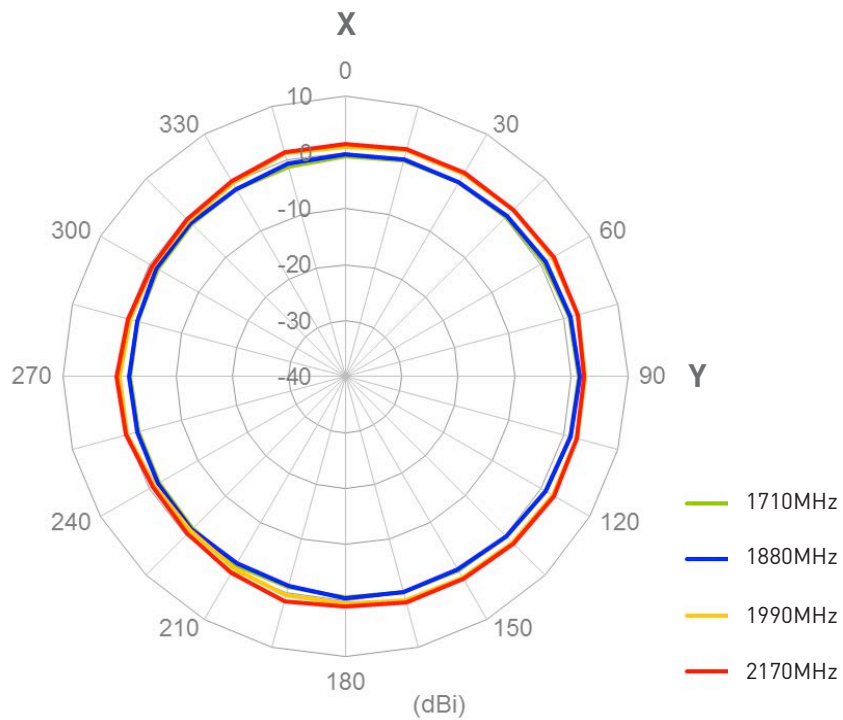
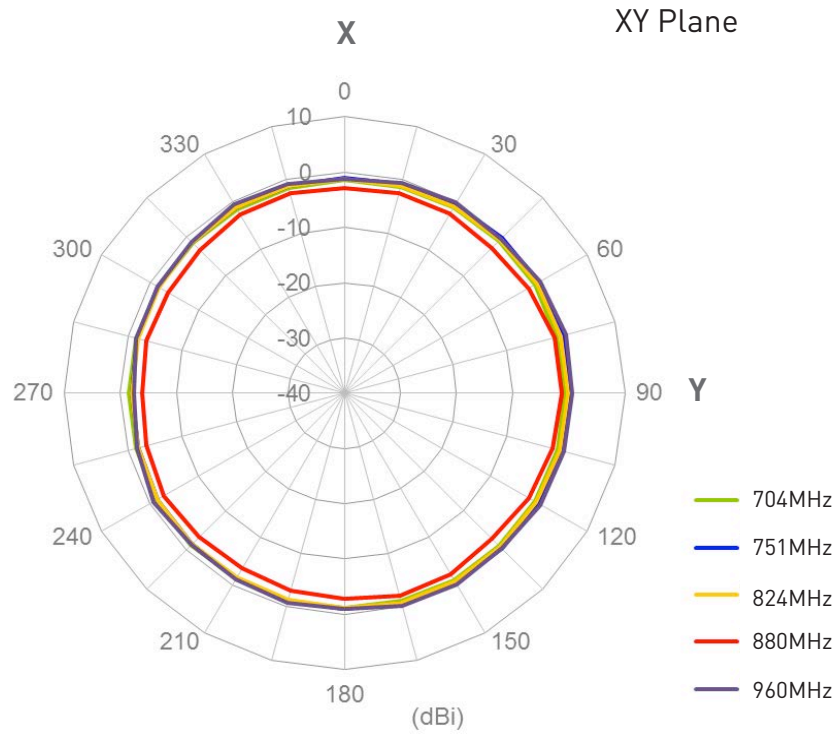

4.4.1 Radiation Patterns

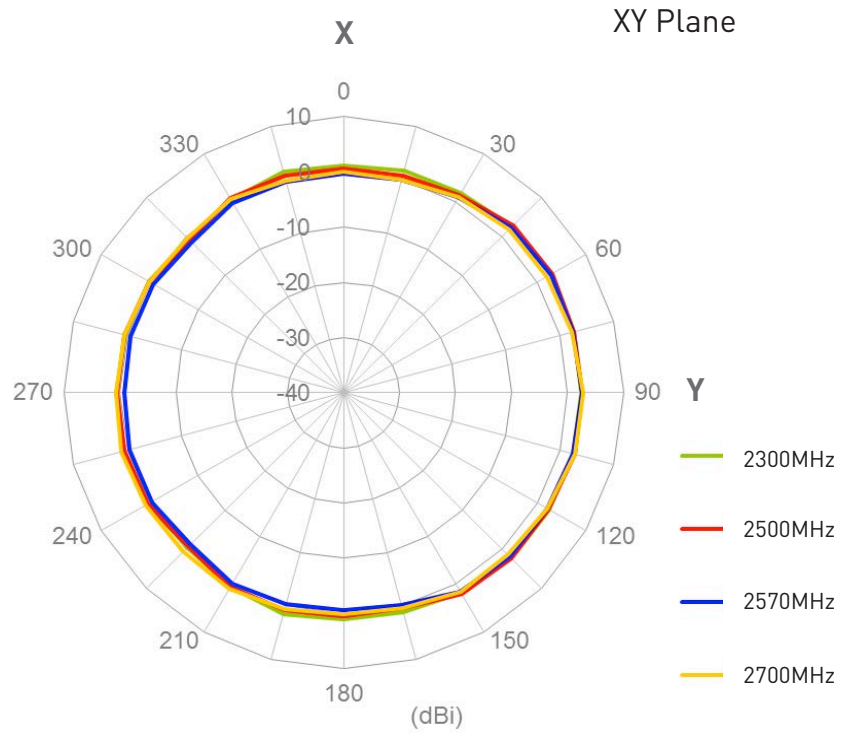

4.4.1 Radiation Patterns

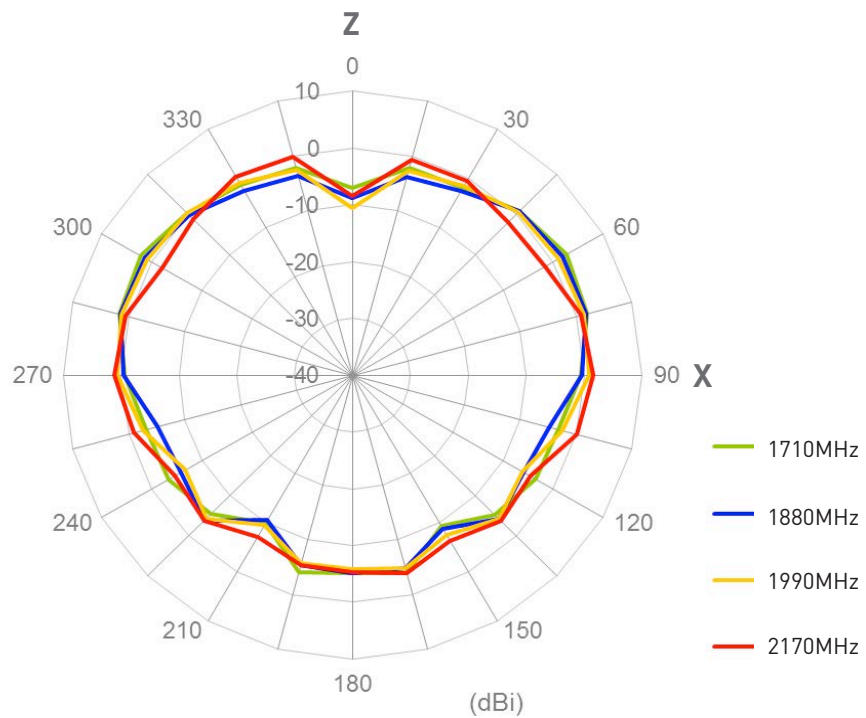
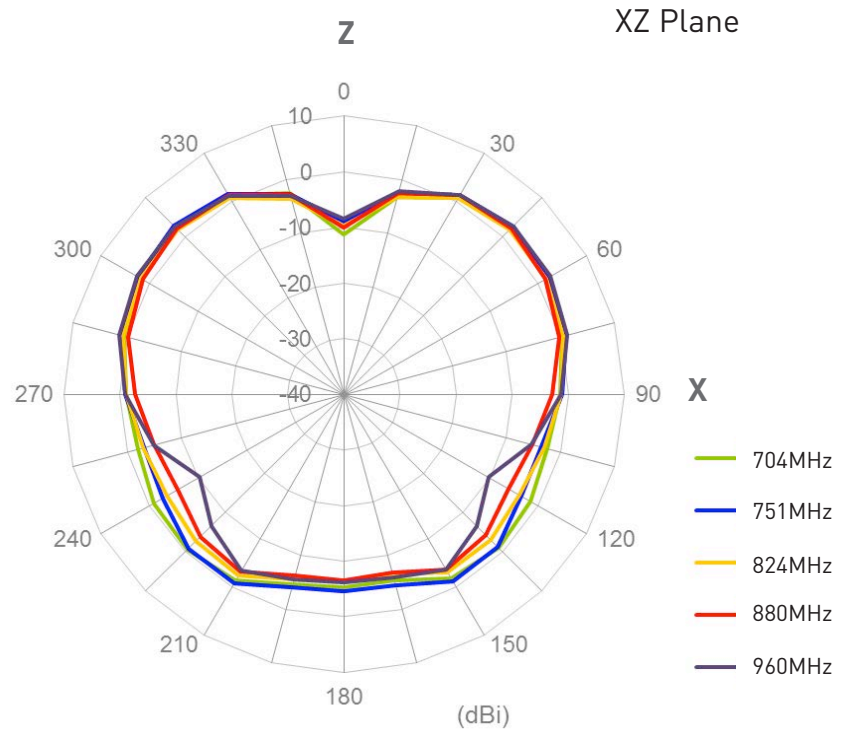

4.4.1 Radiation Patterns

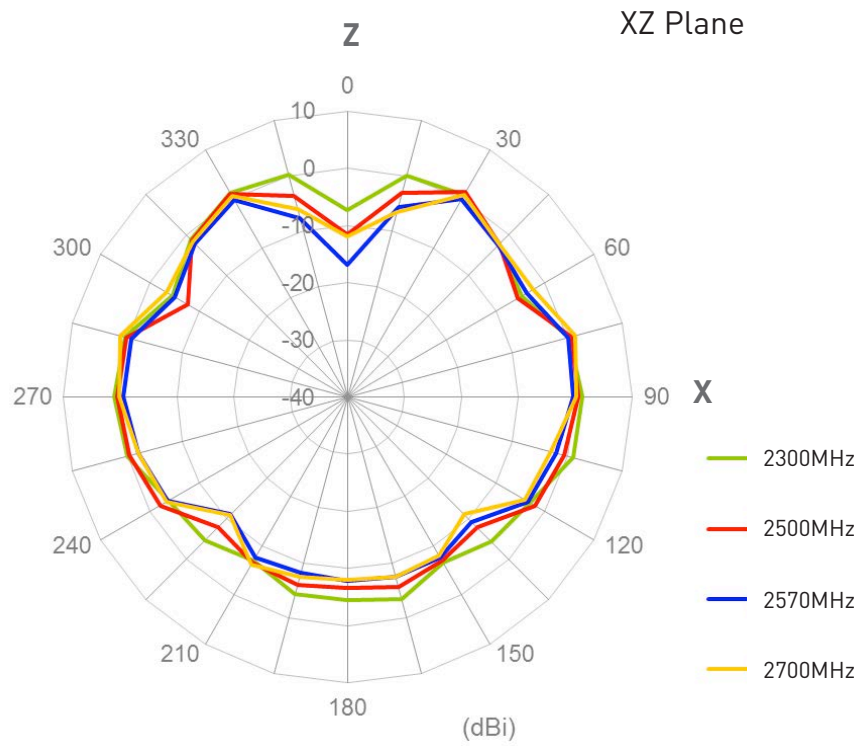

5. Drawing

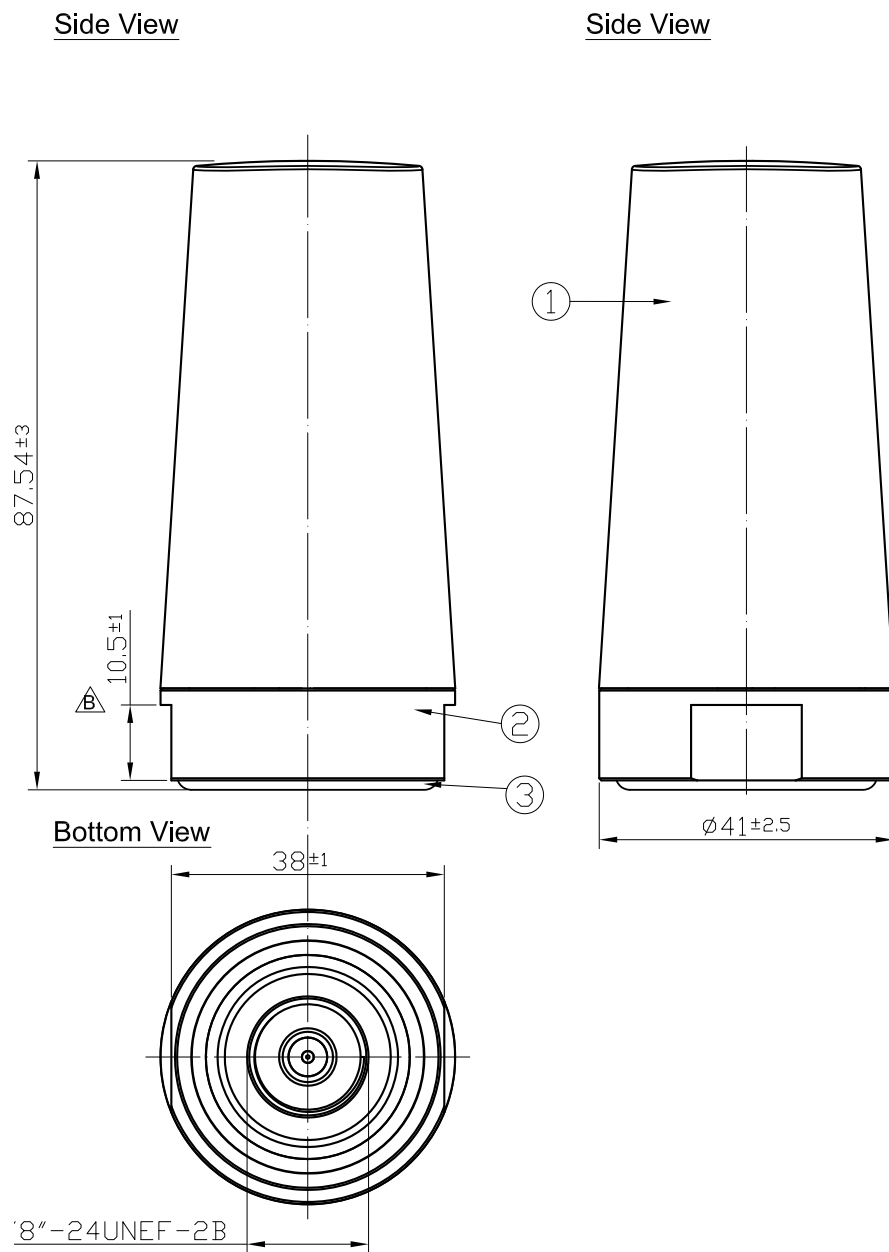

	Name	Material	Finish	QTY
1	Antenna Top	PC+PBT	Black	1
2	Antenna Bottom	SST	Silver	1
3	O-Ring	NBR	Red	1

6. Installation

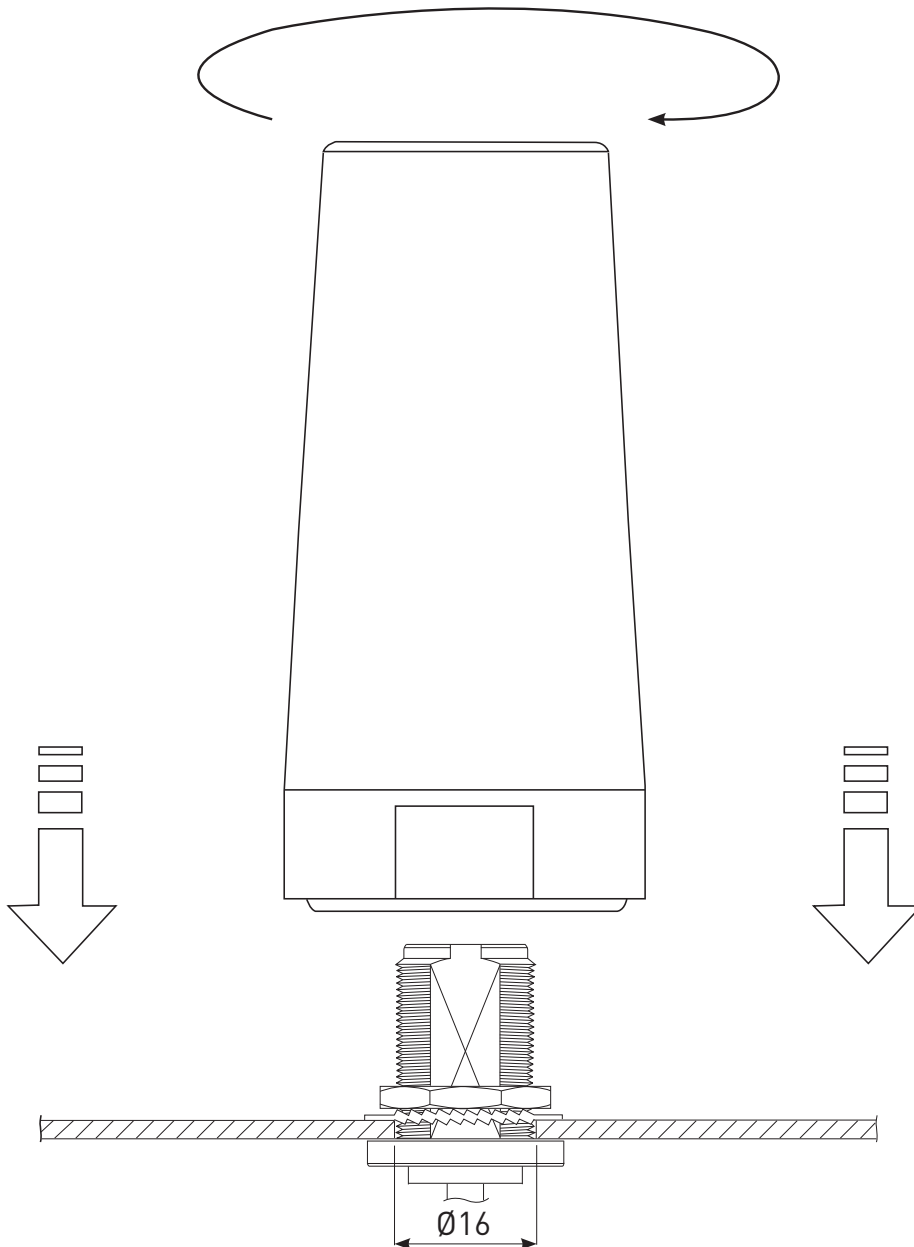

Recommended torque for mounting is 95Nm or 70ft lbs
Maximum torque for mounting is 135.6Nm or 100ft lbs

7. Packaging

- 1 pcs antenna per PE bag
- 2 pcs EPE foam on top and bottom
- 1 pcs antenna per box

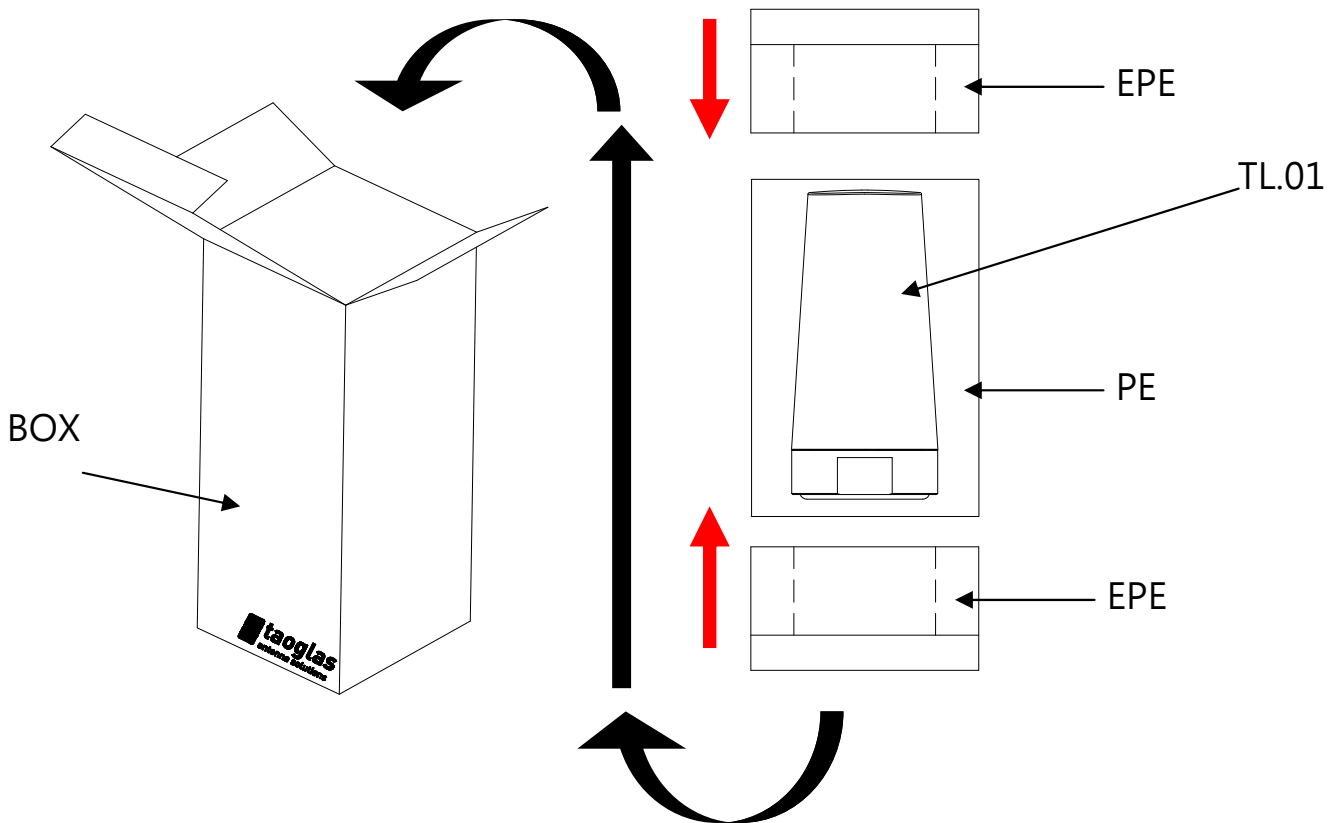

Taoglas makes no warranties based on the accuracy or completeness of the contents of this document and reserves the right to make changes to specifications and

product descriptions at any time without notice. Taoglas reserves all rights to this document and the information contained herein.

Reproduction, use or disclosure to third parties without express permission is strictly prohibited.
Copyright © Taoglas Ltd.