

PXD20-xxDxx Dual Output DC/DC Converter

9 to 18 , 18to 36 and 36 to75 Vdc input, 12 and 15 Vdc Dual Output, 20W



Features

- Low profile: 2.0 x1.0X0.4 inches (50.8X25.4X10.2mm)
- 2:1 wide input voltage of 9-18, 18-36 and 36-75VDC
- 20 Watts output power
- Input to output isolation: 1600Vdc, min
- Operating case temperature range :100°C max
- Over-current protection, auto-recovery
- Output over voltage protection
- ISO 9001 certified manufacturing facilities
- UL60950-1, EN60950-1 and IEC60950-1 licensed
- CE Mark meet 2006/95/EC, 93/68/EEC and 2004/108/EC
- Compliant to RoHS EU directive 2002/95/EC

Applications

- Distributed power architectures
- Communication equipment
- Computer equipment

Option

- Negative logic Remote on/off

General Description

The PXD20-xxDxx dual output series offers 20 watts of output power from a 2 x 1 x 0.4 inch package. This series has a 2:1 wide input voltage of 9-18, 18-36, or 36-75VDC , and features 1600VDC of isolation, short-circuit , and over-voltage protection.

Table of contents

Absolute maximum ratings	P2	Solder and Reflow Considerations	P8
Input Specifications	P2	Characteristic curve	P9
General Specifications	P2	Test configurations	P19
Output Specifications	P3	Part number structure	P20
Thermal Considerations	P4	Mechanical data	P20
Output over current protection	P7	Safety and installation instructions	P21
Short circuit protection	P7	MTBF and Reliability	P21

Absolute Maximum Rating						
Parameter		Device	Min	Typ	Max	Unit
Input Voltage	Continuous	12Dxx			18	Vdc
		24Dxx			36	Vdc
		48Dxx			75	Vdc
	Transient (100ms)	12Dxx			36	Vdc
		24Dxx			50	Vdc
		48Dxx			100	Vdc
Operating temperature range (Operating temperature will be depended De-rating curve)		All	-40		+85	°C
Operating case range		All			100	°C
Storage temperature		All	-55		+105	°C
I/O Isolation voltage		All	1600			Vdc
I/O Isolation capacitance		All			1000	pF

Input Specifications						
Parameter		Device	Min	Typ	Max	Unit
Operating Input Voltage		12Dxx	9	12	18	Vdc
		24Dxx	18	24	36	Vdc
		48Dxx	36	48	75	Vdc
Input reflected ripple current (Please see the testing configurations part.)		All		20		mA p-p
Start Up Time (nominal vin and constant resistive load)	Power up	All		10		mS
	Remove on/off					
Remote ON/OFF						
Positive Logic	DC-DC ON	All	3		12	Vdc
	DC-DC OFF	All	0		1.2	Vdc
Negative Logic (Option)	DC-DC ON	All	0		1.2	Vdc
	DC-DC OFF	All	3		12	Vdc

General Specifications						
Parameter		Device	Min	Typ	Max	Unit
Efficiency Test at Vin, nom and full load (Please see he testing configurations part.)		12D12		86		%
		12D15		86		%
		24D12		87		%
		24D15		88		%
		48D12		88		%
		48D15		88		%
Isolation resistance		All	10 ⁹			Ω
Transient Response Recovery Time (25% load step change)		All		250		μS
Isolation Capacitance		All			1000	pF
Switching Frequency(Test at Vin, nom and full load)		All		500		kHz
Weight		All		27		g
MTBF (please see the MTBF and reliability part)		All		1.791×10 ⁶		hours

Output Specifications					
Parameter	Device	Min	Typ	Max	Unit
Operating Output Range	xxD12	11.88	12.00	12.12	Vdc
	xxD15	14.85	15.00	15.15	Vdc
Line Regulation(LL to HL at Full Load)	All	-0.2		0.2	%
Load Regulation(0% to 100% Full Load)	All	-0.5		0.5	%
Output Ripple & Noise, 20MHz bandwidth (Measured with a 104pF/50V MLCC)	All		100		mVp-p
Temperature Coefficient	All	-0.02		+0.02	%/°C
Output Current	xxD12	0		±833	mA
	xxD15	0		±667	mA
Output Over Voltage Protection Zener diode clamp	xxD12		15		Vdc
	xxD15		18		Vdc
Output Over Current Protection	All			150	% FL
Output Short Circuit Protection	All	Hiccup, automatic recovery			
Output Capacitor Load	xxD12			±680	μF
	xxD15			±450	μF

Thermal Consideration

The power module operates in a variety of thermal environments. However, sufficient cooling should be provided to help ensure reliable operation of the unit. Heat is removed by conduction, convection, and radiation to the surrounding environment. Proper cooling can be verified by measuring the point as indicated in the figure below. The temperature at this location should not exceed 100°C. When operating, adequate cooling must be provided to maintain the test point temperature at or below 100°C. Although the maximum temperature of the power modules is 100°C, lowering this temperature will increase the reliability of the unit.

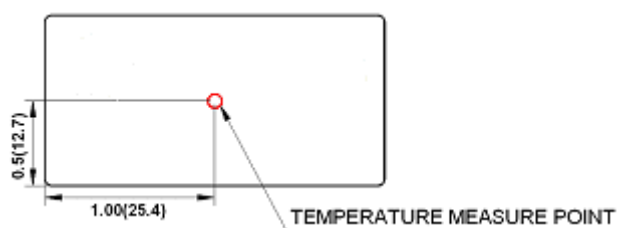

Measurement shown in inches(mm)

TOP VIEW

Following are derating curves for PXD20-12D15, 24D12 and 48D15.

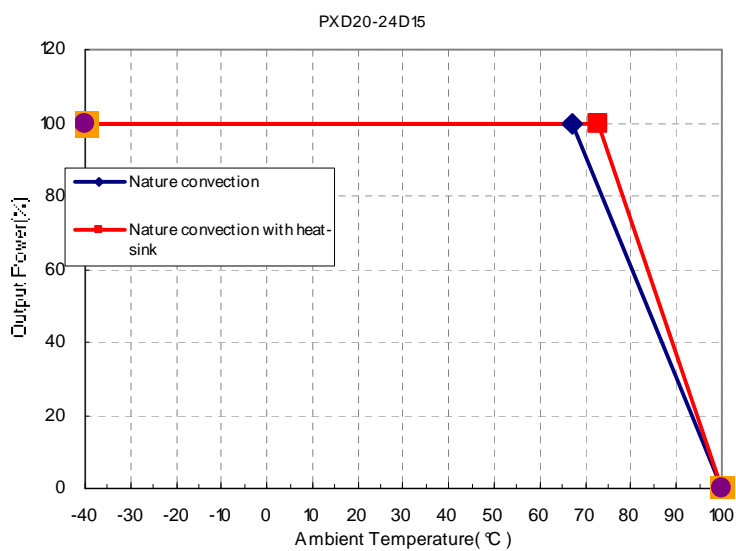
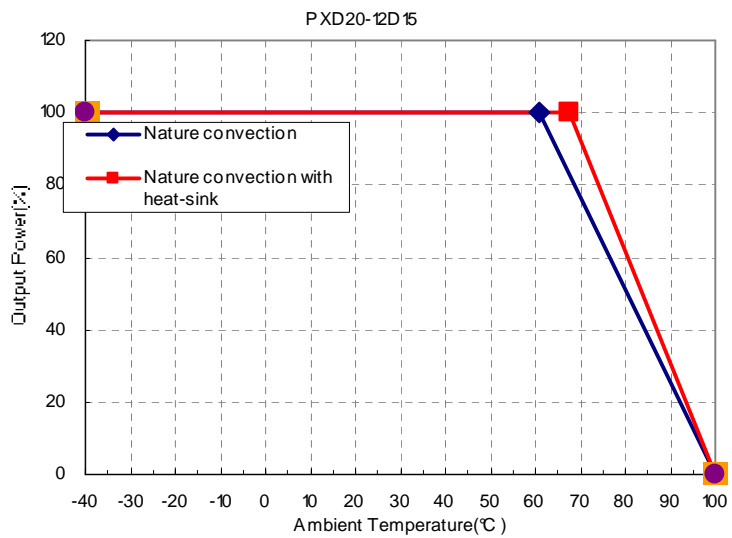

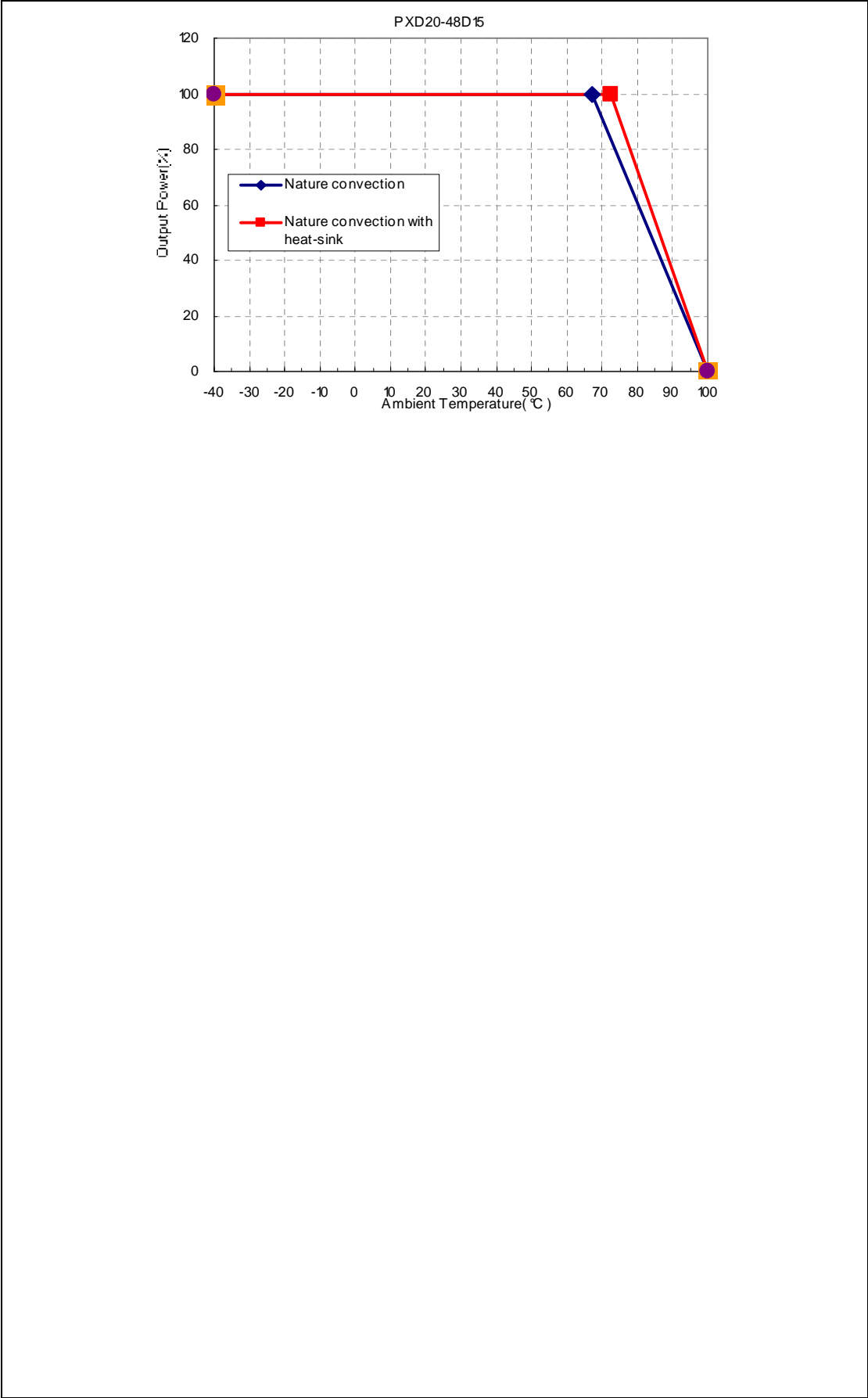

Output over current protection

When excessive output currents occur in the system, circuit protection is required on all power supplies. Normally, overload current is maintained at approximately 150 percent of rated current for PXD20-xxDxx series.

Hiccup-mode is a method of operation in a power supply whose purpose is to protect the power supply from being damaged during an over-current fault condition. It also enables the power supply to restart when the fault is removed. There are other ways of protecting the power supply when it is over-loaded, such as the maximum current limiting or current foldback methods.

One of the problems resulting from over current is that excessive heat may be generated in power devices; especially MOSFET and Schottky diodes and the temperature of those devices may exceed their specified limits. A protection mechanism has to be used to prevent those power devices from being damaged.

The operation of hiccup is as follows. When the current sense circuit sees an over-current event, the controller shuts off the power supply for a given time and then tries to start up the power supply again. If the over-load condition has been removed, the power supply will start up and operate normally; otherwise, the controller will see another over-current event and shut off the power supply again, repeating the previous cycle. Hiccup operation has none of the drawbacks of the other two protection methods, although its circuit is more complicated because it requires a timing circuit. The excess heat due to overload lasts for only a short duration in the hiccup cycle, hence the junction temperature of the power devices is much lower.

Short Circuit Protection

Continuous, hiccup and auto-recovery mode.
During short circuit, the converter still shut down. The average current during this condition will be very low .

Soldering and Reflow Consideration

Lead free wave solder profile for PXD20-xxDxx DIP type

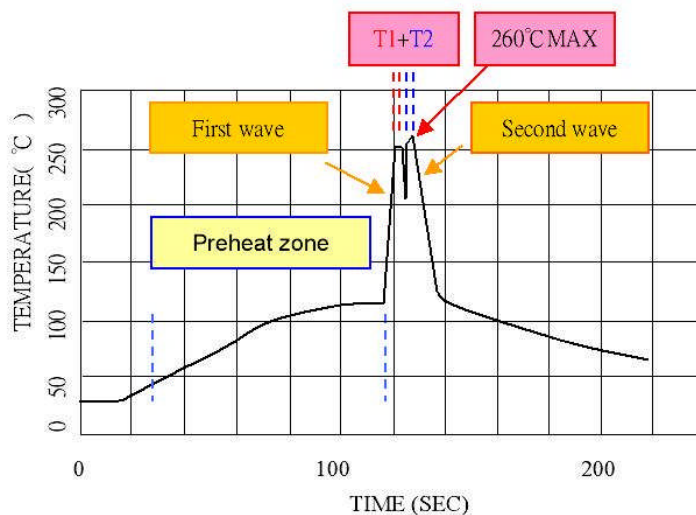

Zone	Reference Parameter
Preheat zone	Rise temp. speed : 3°C / sec max. Preheat temp. : 100~130°C
Actual heating	Peak temp. : 250~260°C Peak time (T1+T2 time) : 4~6 sec

Reference Solder: Sn-Ag-Cu/Sn-Cu

Hand Welding: Soldering iron-Power 90W

Welding Time:2-4 sec

Temp.:380-400 °C

Characteristic Curve

Efficiency

a. Efficiency with load change under different line condition at room temperature

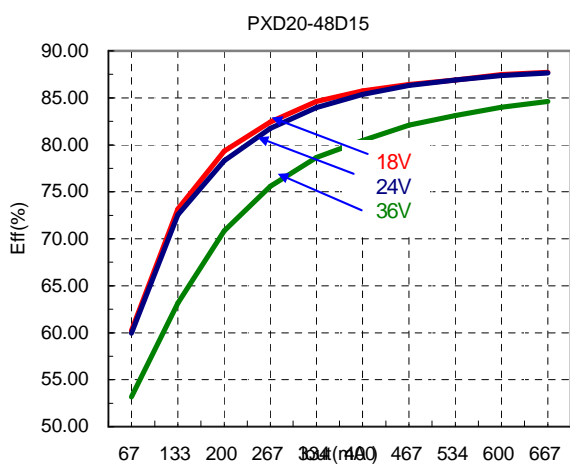
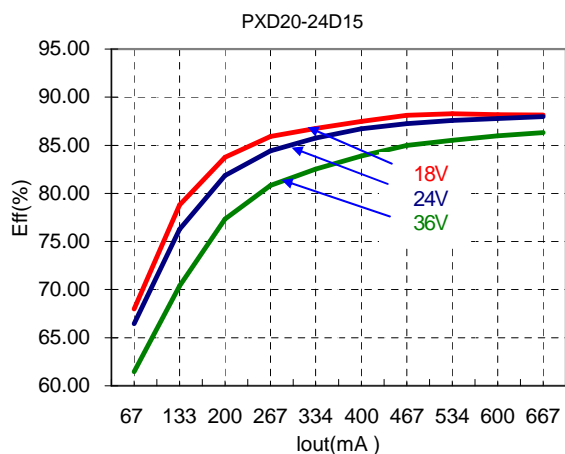
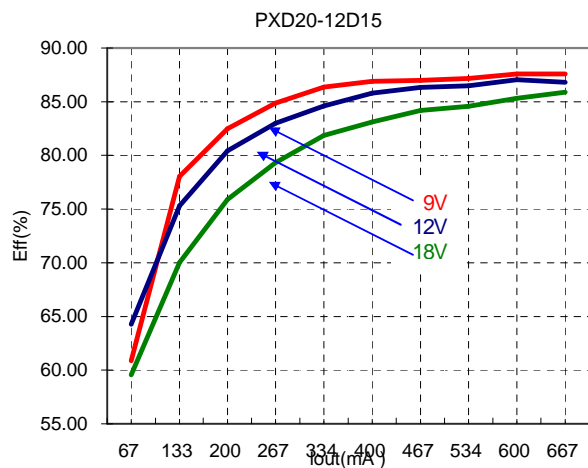

b. Efficiency with line change under different load condition at room temperature

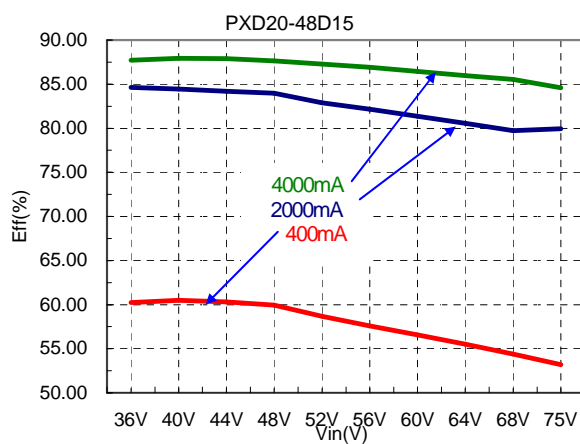
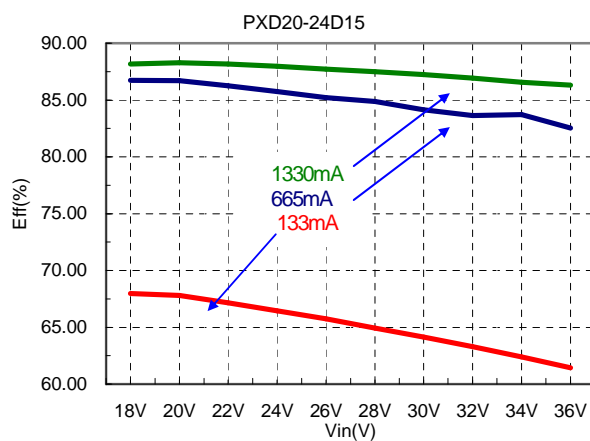
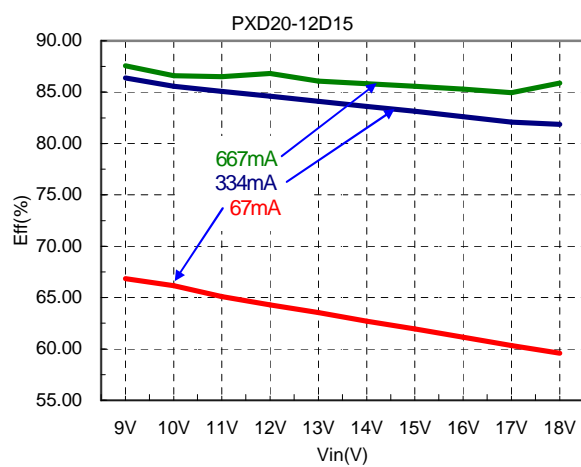

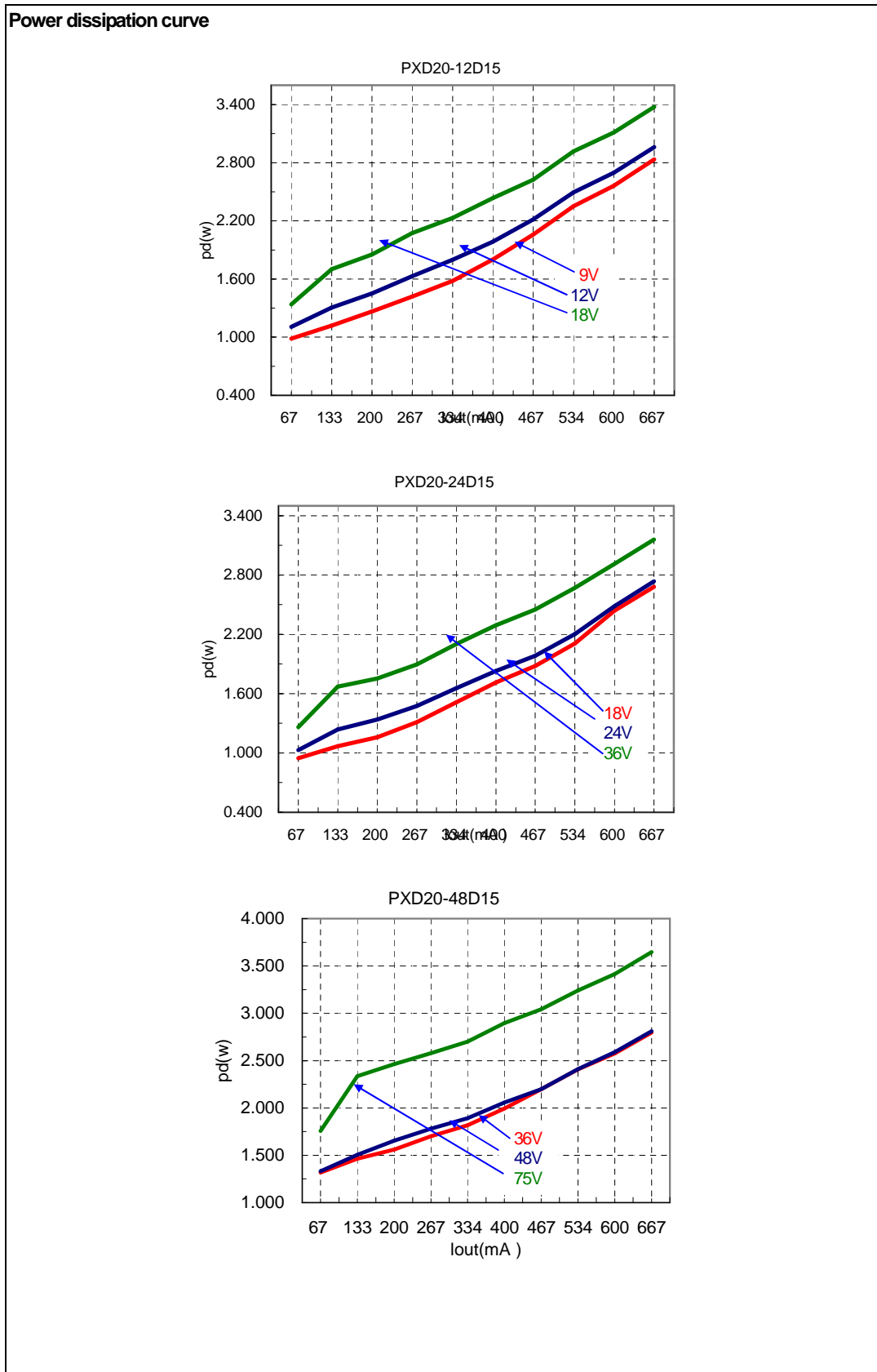

Output ripple & noise

PXD20-12D15

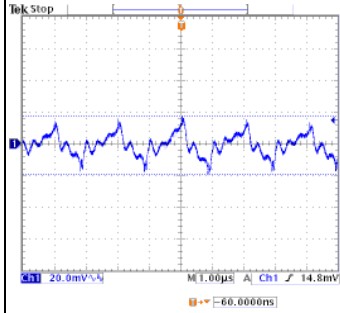

Low Line, Full Load
Output Ripple Noise=36.8mV

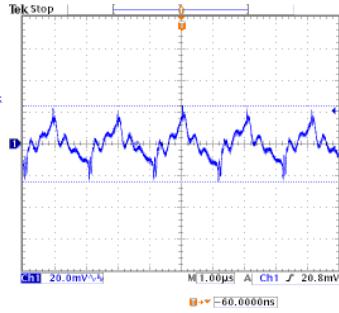

Normal Line, Full Load
Output Ripple Noise=47.6mV

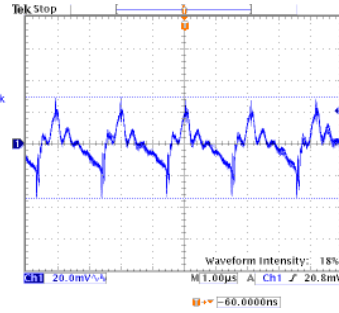

High Line, Full Load
Output Ripple Noise=63.6mV

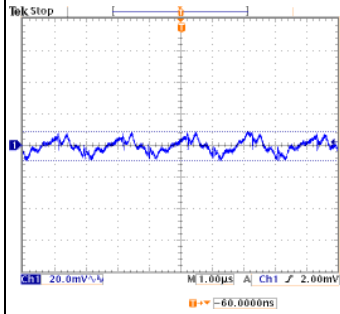

Low Line, Full Load
Output Ripple Noise=18.8mV

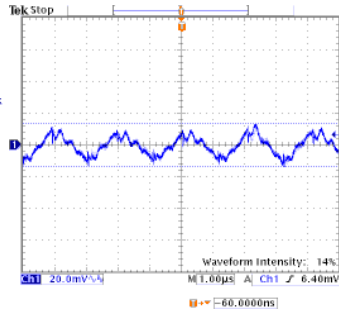

Normal Line, Full Load
Output Ripple Noise=27.2mV

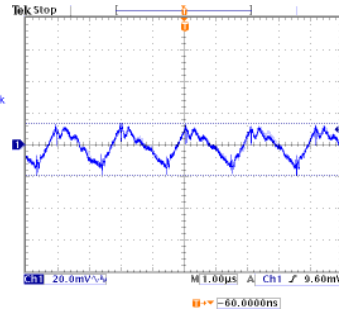

High Line, Full Load
Output Ripple Noise=33.2mV

PXD20-24D15

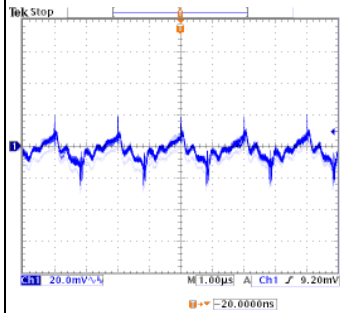

Low Line, Full Load
Output Ripple Noise=44.0mV

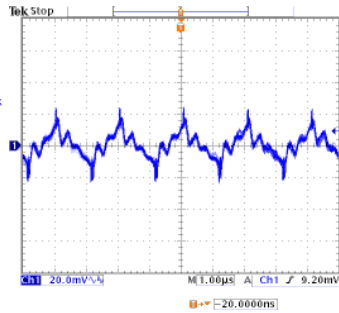

Normal Line, Full Load
Output Ripple Noise=46.4mV

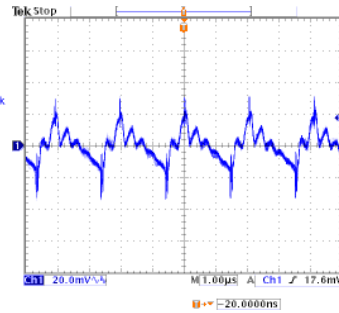

High Line, Full Load
Output Ripple Noise=63.6mV

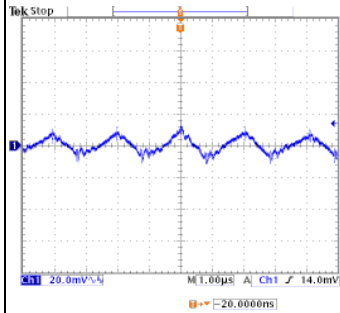

Low Line, Full Load
Output Ripple Noise=27.2mV

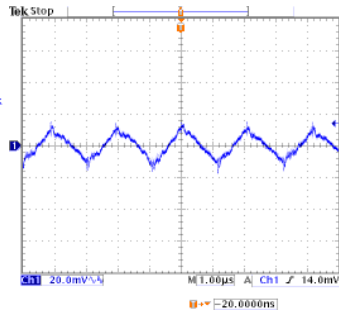

Normal Line, Full Load
Output Ripple Noise=33.6mV

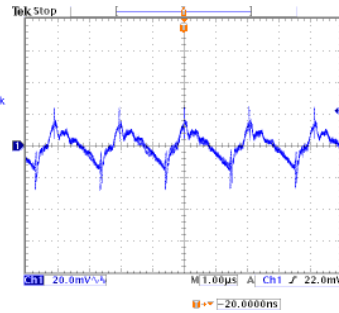

High Line, Full Load
Output Ripple Noise=52.8mV

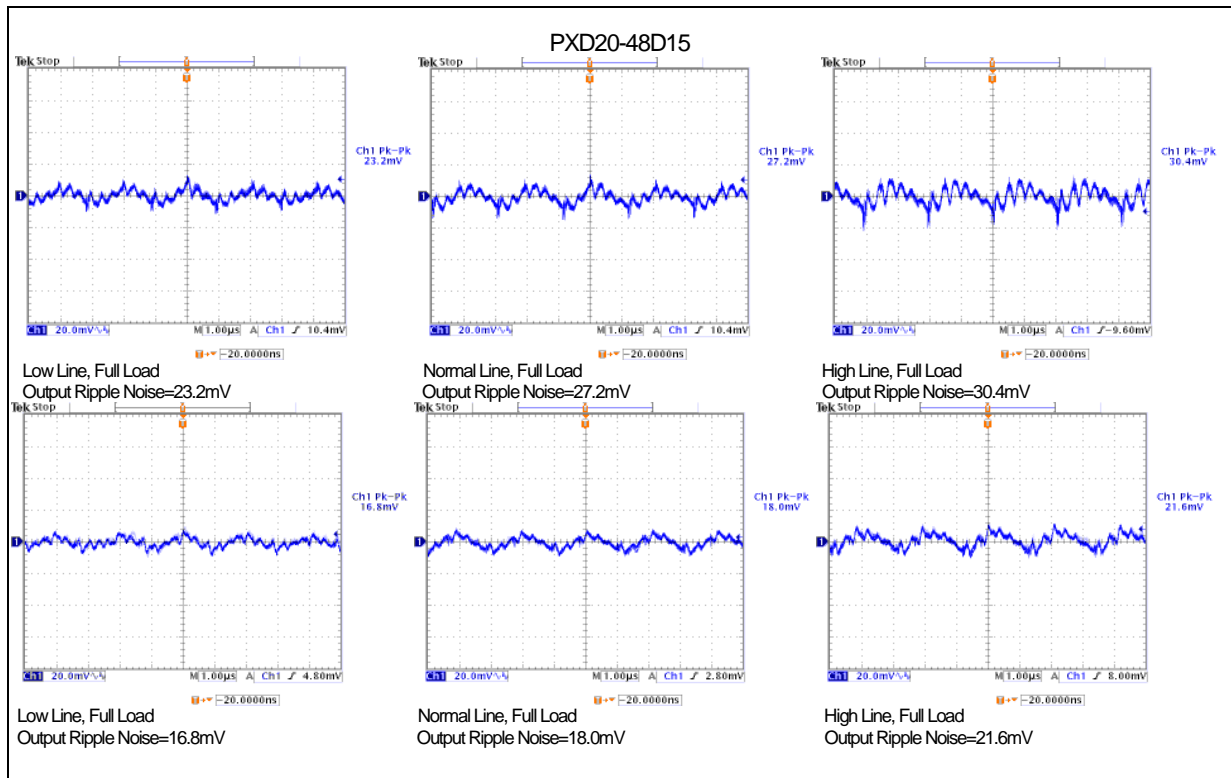

Transient Peak and Response

PXD20-12D15

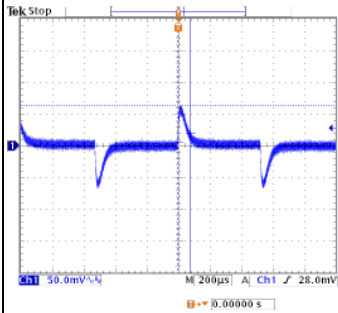

Low Line, Full Load
 Transient Peak 64.0mV
 Transient Response 80uS

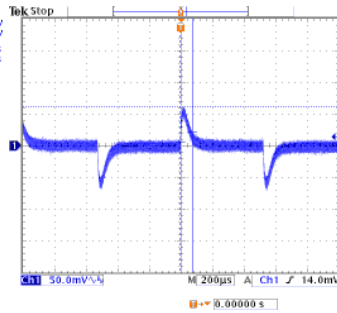

Normal Line, Full Load
 Transient Peak 62.0mV
 Transient Response 76uS

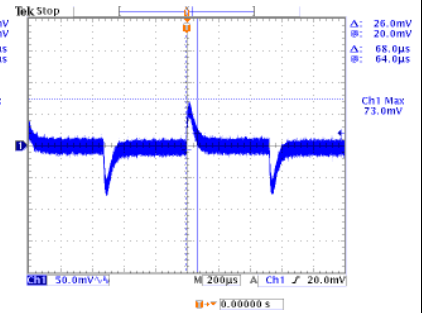

High Line, Full Load
 Transient Peak 73.0mV
 Transient Response 68uS

PXD20-24D15

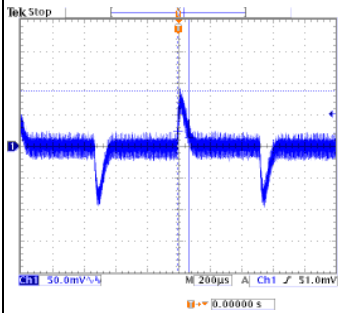

Low Line, Full Load
 Transient Peak 87.0mV
 Transient Response 72uS

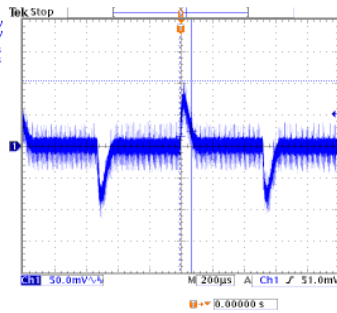

Normal Line, Full Load
 Transient Peak 103.0mV
 Transient Response 72uS

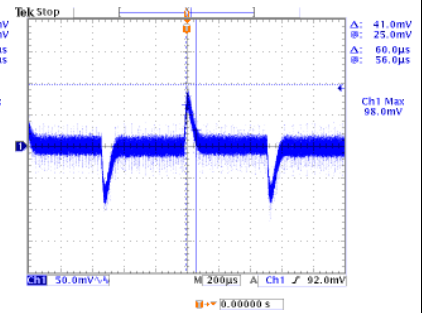

High Line, Full Load
 Transient Peak 98.0mV
 Transient Response 60uS

PXD20-48D15

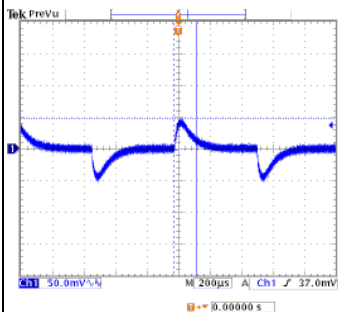

Low Line, Full Load
 Transient Peak 48.0mV
 Transient Response 144uS

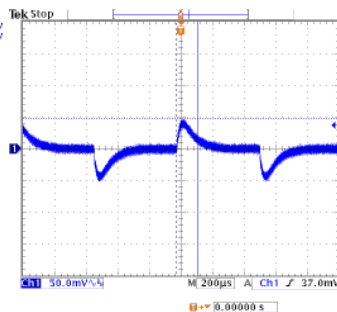

Normal Line, Full Load
 Transient Peak 47.0mV
 Transient Response 136uS

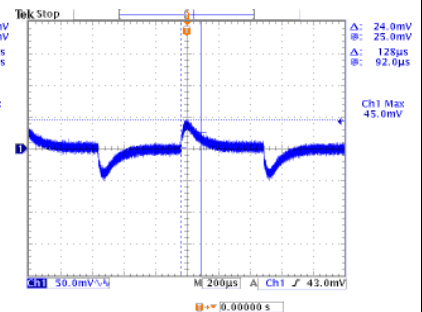

High Line, Full Load
 Transient Peak 45.0mV
 Transient Response 128uS

Inrush Current

PXD20-12D15

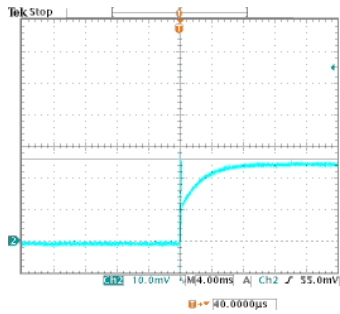

Low Line, Full Load

Inrush current= $(26.0/10) \times 1000\text{mA}=2600\text{mA}$

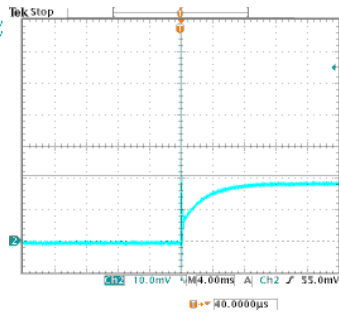

Normal Line, Full Load

Inrush current= $(20.6/10) \times 1000\text{mA}=2060\text{mA}$

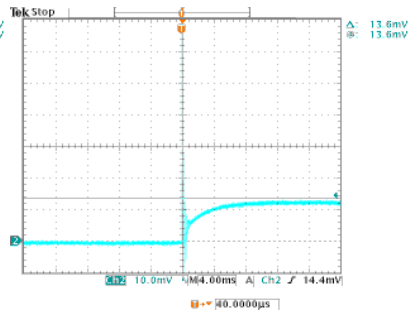

High Line, Full Load

Inrush current= $(13.6/10) \times 1000\text{mA}=1360\text{mA}$

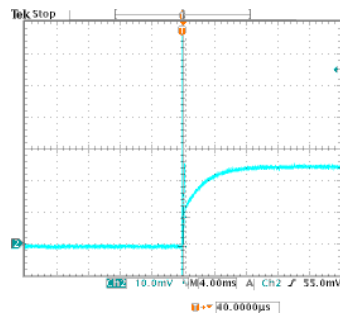

Low Line, Full Load

Duration: 480uS

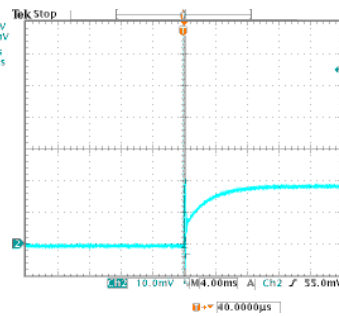

Normal Line, Full Load

Duration: 320uS

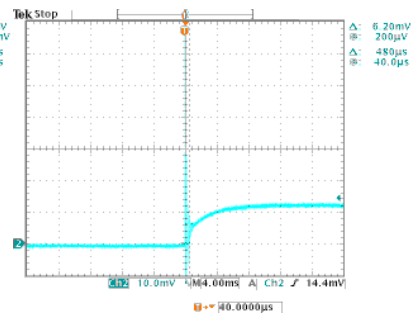

High Line, Full Load

Duration: 480uS

PXD20-24D15

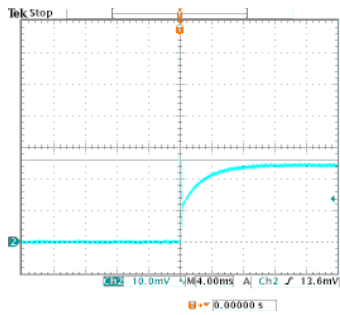

Low Line, Full Load

Inrush current= $(26.0/10) \times 500\text{mA}=1300\text{mA}$

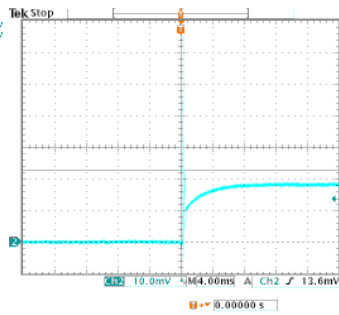

Normal Line, Full Load

Inrush current= $(22.6/10) \times 500\text{mA}=1130\text{mA}$

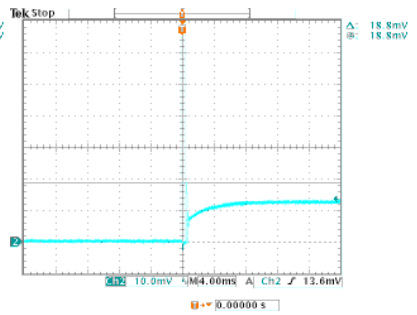

High Line, Full Load

Inrush current= $(18.8/10) \times 500\text{mA}=940\text{mA}$

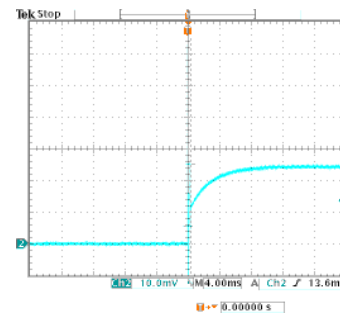

Low Line, Full Load

Duration: 320uS

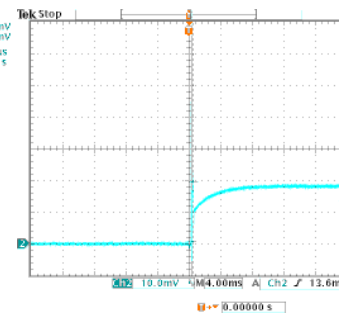

Normal Line, Full Load

Duration: 240uS

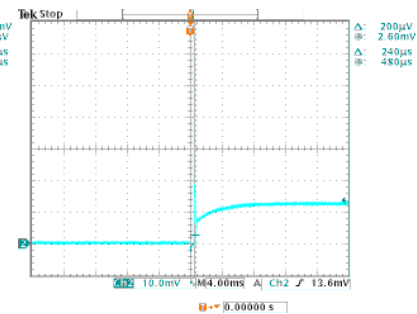

High Line, Full Load

Duration: 240uS

PXD20-48D15

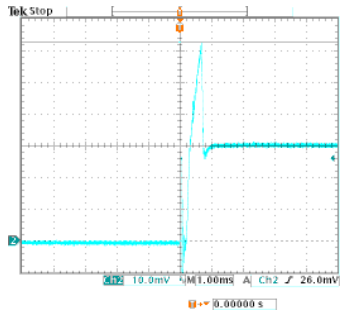

Low Line, Full Load

Inrush current=(62.8/10) X200mA=1256mA

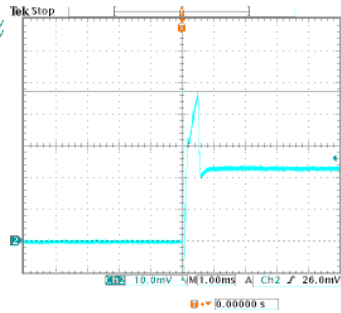

Normal Line, Full Load

Inrush current=(47.2/10) x200mA=944mA

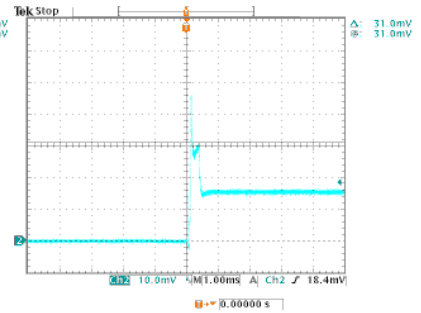

High Line, Full Load

Inrush current=(31.0/10) x200mA=620mA

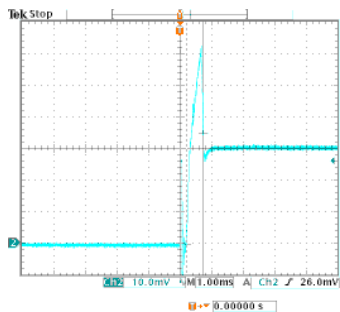

Low Line, Full Load

Duration: 540uS

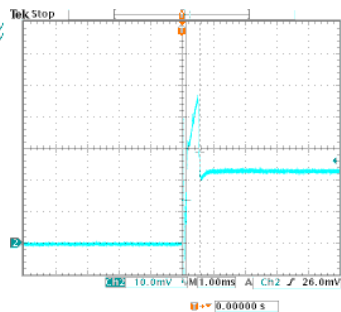

Normal Line, Full Load

Duration: 420uS

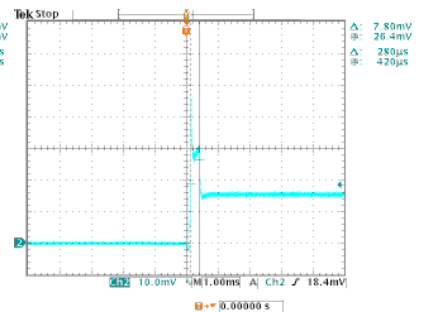

High Line, Full Load

Duration: 280uS

Input Ripple Current

PXD20-12D15

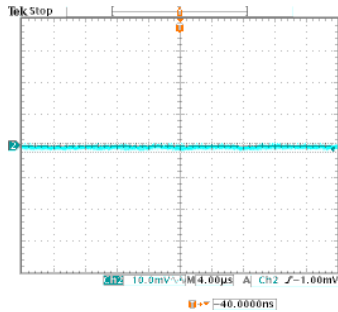

Low Line, Full Load
Ripple current= $(2.8/10) \times 10=2.8\text{mA}$

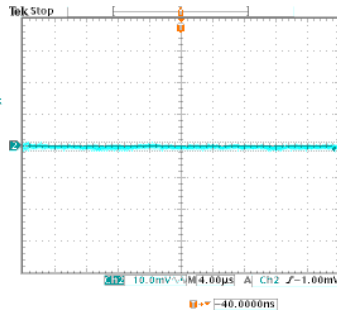

Normal Line, Full Load
Ripple current= $(3.0/10) \times 10=3.0\text{mA}$

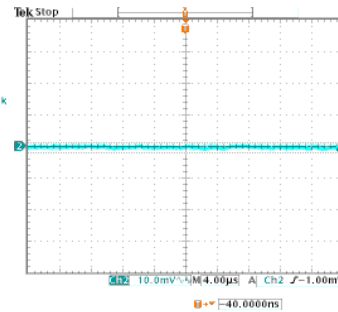

High Line, Full Load
Ripple current= $(3.2/10) \times 10=3.2\text{mA}$

PXD20-24D15

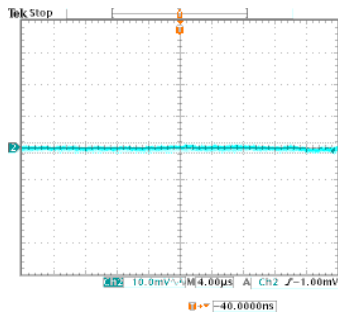

Low Line, Full Load
Ripple current= $(3.2/10) \times 10=3.2\text{mA}$

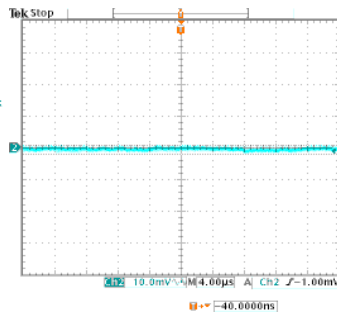

Normal Line, Full Load
Ripple current= $(2.8/10) \times 10=2.8\text{mA}$

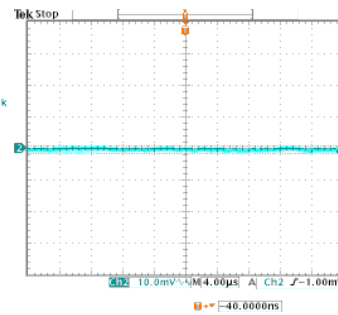

High Line, Full Load
Ripple current= $(2.6/10) \times 10=2.6\text{mA}$

PXD20-48D15

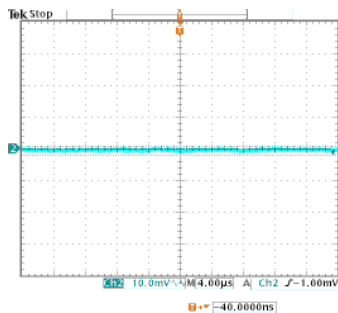

Low Line, Full Load
Ripple current= $(2.8/10) \times 10=2.8\text{mA}$

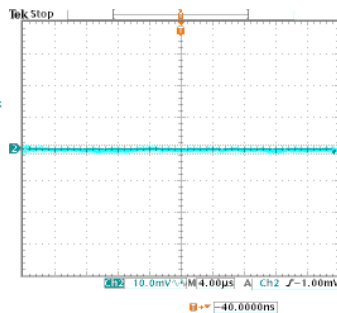

Normal Line, Full Load
Ripple current= $(3.0/10) \times 10=3.0\text{mA}$

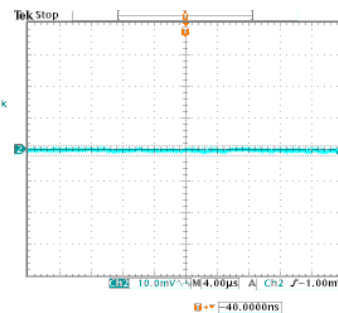

High Line, Full Load
Ripple current= $(3.2/10) \times 10=3.2\text{mA}$

Delay Time and Raise Time

PXD20-12D15

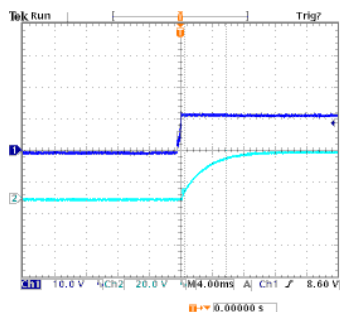

Normal Line, Full Load
Rise Time=5.382mS

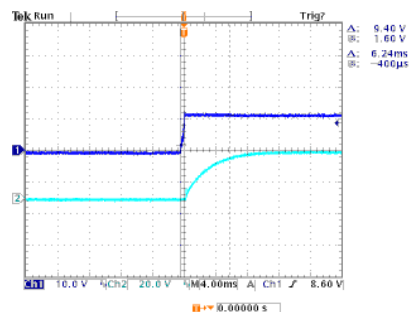

Normal Line, Full Load
Delay Time=6.24mS

PXD20-24D15

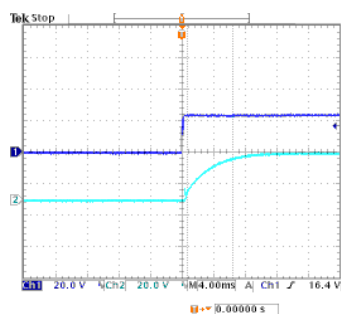

Normal Line, Full Load
Rise Time=5.797mS

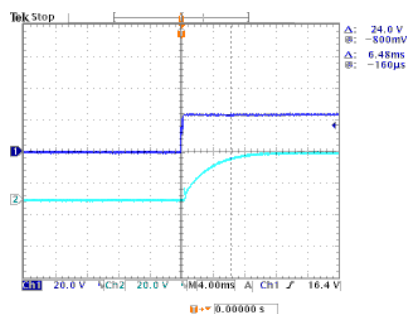

Normal Line, Full Load
Delay Time=6.48mS

PXD20-48D15

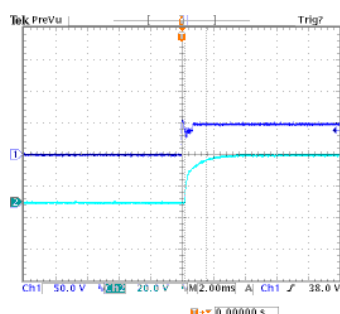

Normal Line, Full Load
Rise Time=1.365mS

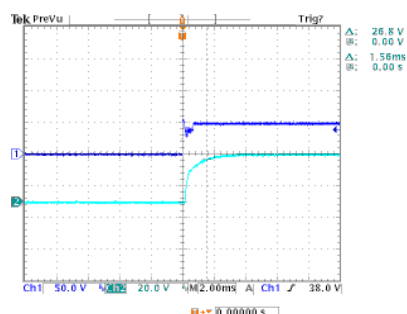

Normal Line, Full Load
Delay Time=1.56mS

Test Configurations

Input reflected-ripple current Measurement Test:

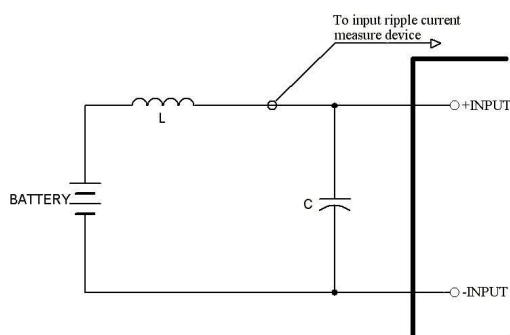

Component	Value	Voltage	Reference
L	12μH	----	----
C	100μF	100V	Aluminum Electrolytic Capacitor

Peak-to-peak output ripple & noise Measurement Test:

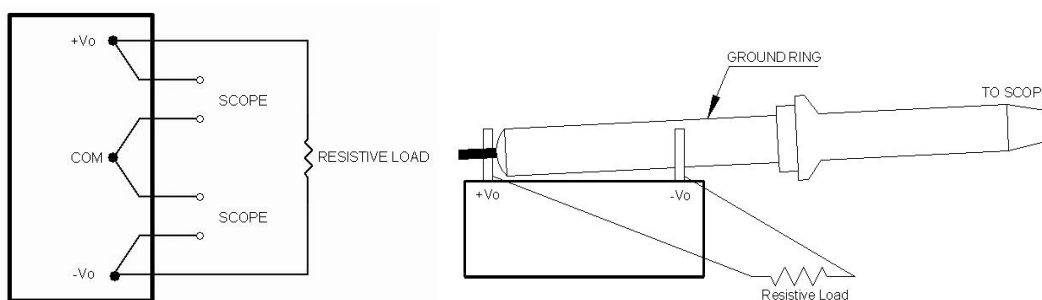

Output Voltage and Efficiency Measurement Test:

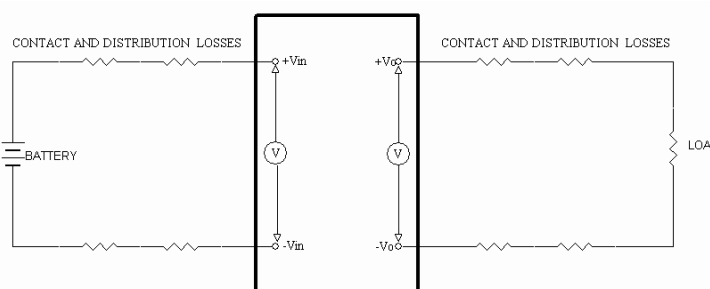

Note: All measurements are taken at the module terminals.

$$Efficiency = \left(\frac{V_o \times I_o}{V_{in} \times I_{in}} \right) \times 100\%$$

Part Number Structure

PXD 20 - 48 D 12

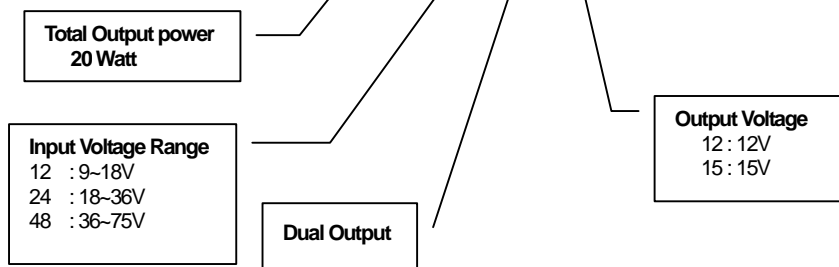

Mechanical Data

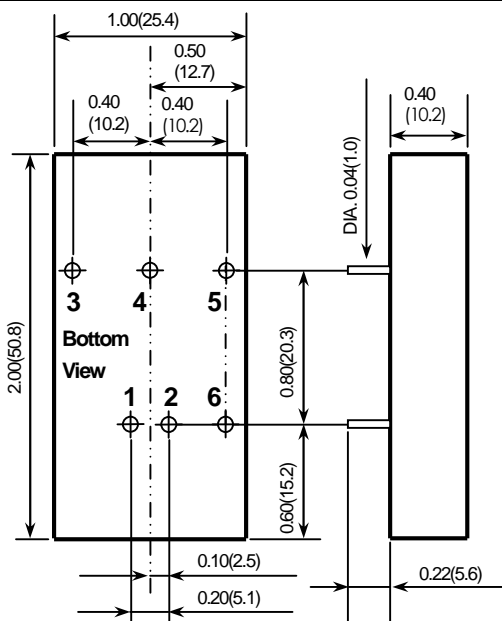

PIN CONNECTION	
PIN	FUNCTION
1	+ INPUT
2	- INPUT
3	+ OUTPUT
4	COMMON
5	- OUTPUT
6	CTRL (Option)

1. All dimensions in Inches (mm)
2. Pin pitch tolerance $\pm 0.0014(0.35)$
3. Tolerance : $x.xx \pm 0.02$ ($x.x \pm 0.5$)
 $x.xxx \pm 0.01$ ($x.xx \pm 0.25$)

Safety and Installation Instruction

Isolation consideration

The PXD20-xxDxx series features 1.6k Volt DC isolation from input to output, input to case, and output to case. The input to output resistance is greater than 10^9 ohms. Nevertheless, if the system using the power module needs to receive safety agency approval, certain rules must be followed in the design of the system using the model. In particular, all of the creepage and clearance requirements of the end-use safety requirement must be observed. These documents include UL-60950-1, EN60950-1 and CSA 22.2-960, although specific applications may have other or additional requirements.

Fusing Consideration

Caution: This power module is not internally fused. An input line fuse must always be used. This encapsulated power module can be used in a wide variety of applications, ranging from simple stand-alone operation to an integrated part of a sophisticated power architecture. To maximum flexibility, internal fusing is not included; however, to achieve maximum safety and system protection, always use an input line fuse. The safety agencies require a slow-blow fuse with maximum rating of 3 A. Based on the information provided in this data sheet on inrush energy and maximum dc input current, the same type of fuse with lower rating can be used. Refer to the fuse manufacturer's data for further information.

Minimum Load Requirement

10%(of full load) minimum load required. The 10% minimum load requirement is in order to meet all performance specifications. The PXD20-xxDxx series does not properly maintain regulation and operate under a no load condition. The output voltage drops about 10%.

MTBF and Reliability

The MTBF of PXD20-xxDxx series of DC/DC converters has been calculated using:

1.MIL-HDBK-217F under the following conditions:

Nominal Input Voltage

$I_o = I_o, \text{max}$

$T_a = 25^\circ\text{C}$

The resulting figure for MTBF is 6.842×10^5 hours.

2.Bell-core TR-NWT-000332 Case I:

50% stress, Operating Temperature at 40°C (Ground fixed and controlled environment)

The resulting figure for MTBF is 1.791×10^6 hours.