

Gravity: I2C ADS1115 16-Bit ADC Module(Arduino & Raspberry Pi Compatible) SKU: DFR0553

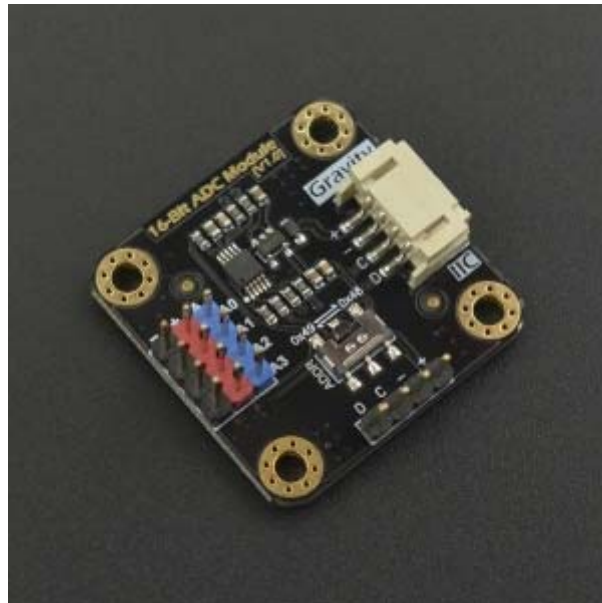

DFRobot I2C ADS1115 16-bit ADC module can accurately collect and convert analog signals. Through this ADC module, Raspberry Pi can easily use a wide range of Gravity series analog sensors to measure various signals, and perceive this world.

Raspberry Pi is a common master control board which is powerful in its functions, but the I/O pins of Raspberry Pi can read digital signals only, what's more, only through an external analog-to-digital conversion (ADC) module can it read signals of analog sensor or device, it is not convenient to use.

DFRobot I2C ADS1115 16-bit ADC module is specially designed for Raspberry Pi and Gravity series analog sensors, which greatly reduces the difficulty of using the Gravity series analog sensors, plug and play, no welding, very convenient. The number of Gravity series sensors is large and its wide variety can meet the needs of various sensors of the Raspberry Pi.

This module uses 16-bit ADC chip ADS1115, supports 3.3 ~ 5V wide voltage power supply. The chip has a precision reference voltage and programmable gain adjustment (PGA), therefore, accurate acquisition and conversion can be performed for both weak and highly variable signals. So it is also applicable to all types of applications that the main control board needs to accurately collect the analog signals.

One ADC module can read analog signals of 4 channels. Because of the on-board I2C address selection switch, it supports the cascade of two ADC modules and can read analog signals of 8 channels, it can satisfy the needs of various applications.

Specification

- Supply Voltage (VCC): 3.3~5.0V
- Analog Signal Detection Range: 0~VCC
- Number of Analog Channels: 4
- ADC Bits: 16 Bit
- Operating Current: 2~3mA (Not include sensor module)
- Interface Type: Gravity I2C
- Interface Level: High 3.3V, Low 0V
- Product Size: 32mm * 32mm(1.26in*1.26in)

Board Overview

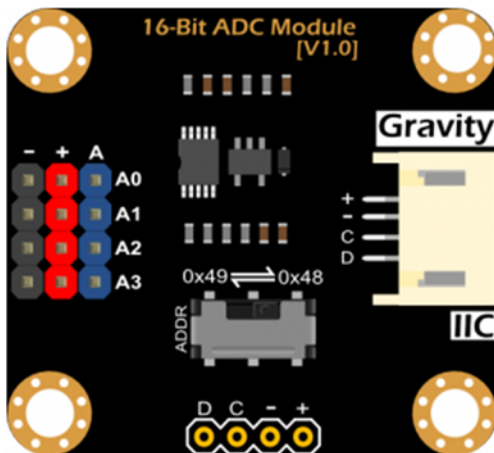

Gravity: I2C ADS1115 16-Bit ADC Module(Arduino & Raspberry Pi Compatible)

| Num | Label | Description |
|------|-------------|---|
| + | VCC | Power VCC(+3.3~5.0V) |
| - | GND | Power GND(0V) |
| C | SCL | I2C Bus Clock Line |
| D | SDA | I2C Bus Data Line |
| A | Analog In | Analog Input Channels: A0, A1, A2, A3 |
| ADDR | I2C Address | I2C address selection switch, I2C address: 0x48, 0x49 |

Tutorial

 The voltage on analog input pins must be less than $VCC+0.3V$! That is, Analog Signal $\leq VCC+0.3V$

Arduino Tutorial

This tutorial will demonstrate how to use the ADC module to read 4 channels analog signals with the Arduino board. Please switch the I2C address to 0x48.

Requirements

- **Hardware**
- DFRduino UNO R3 (or similar) x 1
- I2C ADS1115 16-bit ADC Module x 1
- Analog Sensors(sound, voltage, temperature, ambient light, etc.) x4
- Gravity 4pin Cable (or several DuPont cables) x1
- **Software**
- Arduino IDE (Version requirements: V1.0.x or V1.8.x), [Click to Download Arduino IDE from Arduino®](#)

Connection Diagram

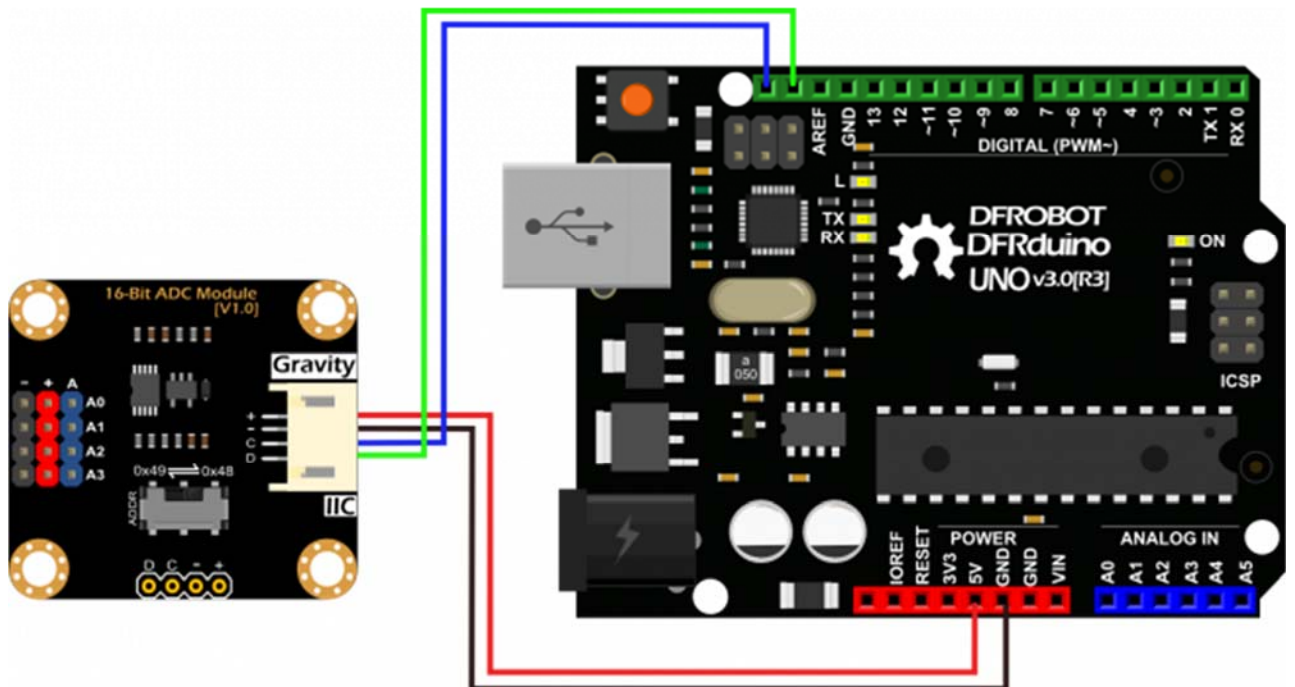

Sample Code

Please download the DFRobot_ADS1115 Library and install it.
How to install Libraries in Arduino IDE

Description of the I2C Address in this Library:

- ADS1115_IIC_ADDRESS0 : 0x48
- ADS1115_IIC_ADDRESS1 : 0x49

```
/*
 * file ADS1115_ReadVoltage.ino
 *
 * @ https://github.com/DFRobot/DFRobot_ADS1115
 *
 * connect ADS1115 I2C interface with your board (please reference board c
ompatibility)
 *
 * The voltage value read by A0 A1 A2 A3 is printed through the serial por
t.
 *
 * Copyright [DFRobot](http://www.dfrobot.com), 2016
 * Copyright GNU Lesser General Public License
 *
 * version V1.0
 * date 2018-01-21
 */
#include <Wire.h>
#include <DFRobot_ADS1115.h>

DFRobot_ADS1115 ads;

void setup(void)
{
    Serial.begin(115200);
    ads.setAddr_ADS1115(ADS1115_IIC_ADDRESS0); // 0x48
    ads.setGain(eGAIN_TWOTHIRDS); // 2/3x gain
    ads.setMode(eMODE_SINGLE); // single-shot mode
```

```

ads.setRate(eRATE_128);           // 128SPS (default)
ads.setOSMode(eOSMODE_SINGLE);    // Set to start a single-conversion
ads.init();
}

void loop(void)
{
    if (ads.checkADS1115())
    {
        int16_t adc0, adc1, adc2, adc3;
        adc0 = ads.readVoltage(0);
        Serial.print("A0:");
        Serial.print(adc0);
        Serial.print("mV, ");
        adc1 = ads.readVoltage(1);
        Serial.print("A1:");
        Serial.print(adc1);
        Serial.print("mV, ");
        adc2 = ads.readVoltage(2);
        Serial.print("A2:");
        Serial.print(adc2);
        Serial.print("mV, ");
        adc3 = ads.readVoltage(3);
        Serial.print("A3:");
        Serial.print(adc3);
        Serial.println("mV");
    }
    else
    {
        Serial.println("ADS1115 Disconnected!");
    }

    delay(1000);
}

```

Expected Results

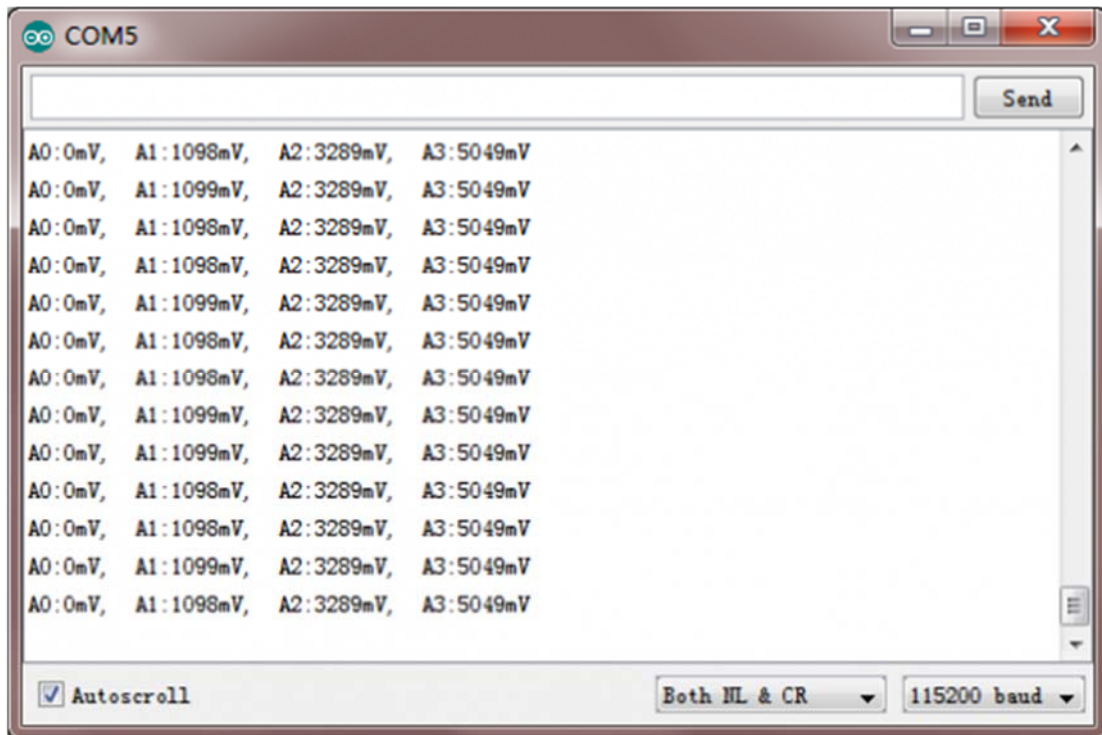

Raspberry Pi Tutorial

This tutorial will demonstrate how to use the ADC module to read 4 channels analog signals with Raspberry Pi. Please switch the I2C address to 0x48.

Requirements

- **Hardware**
- Raspberry Pi 3 Model B (or similar) x 1
- I2C ADS1115 16-bit ADC Module x 1
- Analog Sensors(sound, voltage, temperature, ambient light, etc.) x4
- Gravity 4pin Cable (or several DuPont cables) x1
- **Software**
- DFRobot_ADS1115 Raspberry Driver
- RASPBIAN

Connection Diagram

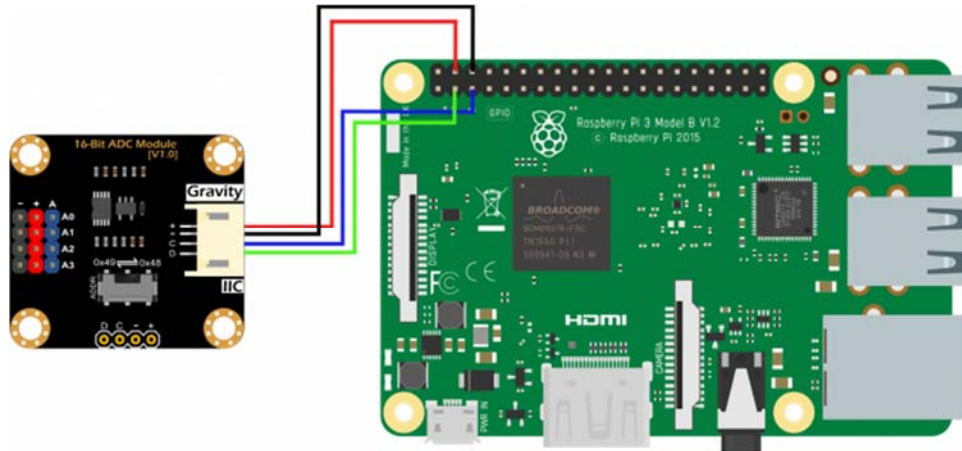

Install Driver

- 1. Open the Raspberry Pi I2C interface. If it is already open, skip this step.

Open Terminal, type the following command, and press Enter:

```
sudo raspi-config
```

Then use the up and down keys to select “5 Interfacing Options”, press Enter, select “P5 I2C” and press Enter to confirm “YES”. Restart the Raspberry Pi.

- 2. Install the Python related libraries and git, then Raspberry Pi requires networking. If it is already installed, skip this step.

In the terminal, type in the following commands in order, and press Enter:

```
sudo apt-get update
sudo apt-get install build-essential python-dev python-smbus git
```

- 3. Download the driver and run. In the terminal, type in the following commands in order, and press Enter.

```
cd ~
git clone https://github.com/DFRobot/DFRobot\_ADS1115.git
cd DFRobot_ADS1115/RaspberryPi/Python
sudo python DFRobot_ADS1115.py
```

Run the Sample Code

- In the terminal, type the following commands in order, and press Enter:

```
cd ~/DFRobot_ADS1115/RaspberryPi/Python/ADS1115_ReadVoltage
sudo python ADS1115_ReadVoltage.py
```

Expected Results

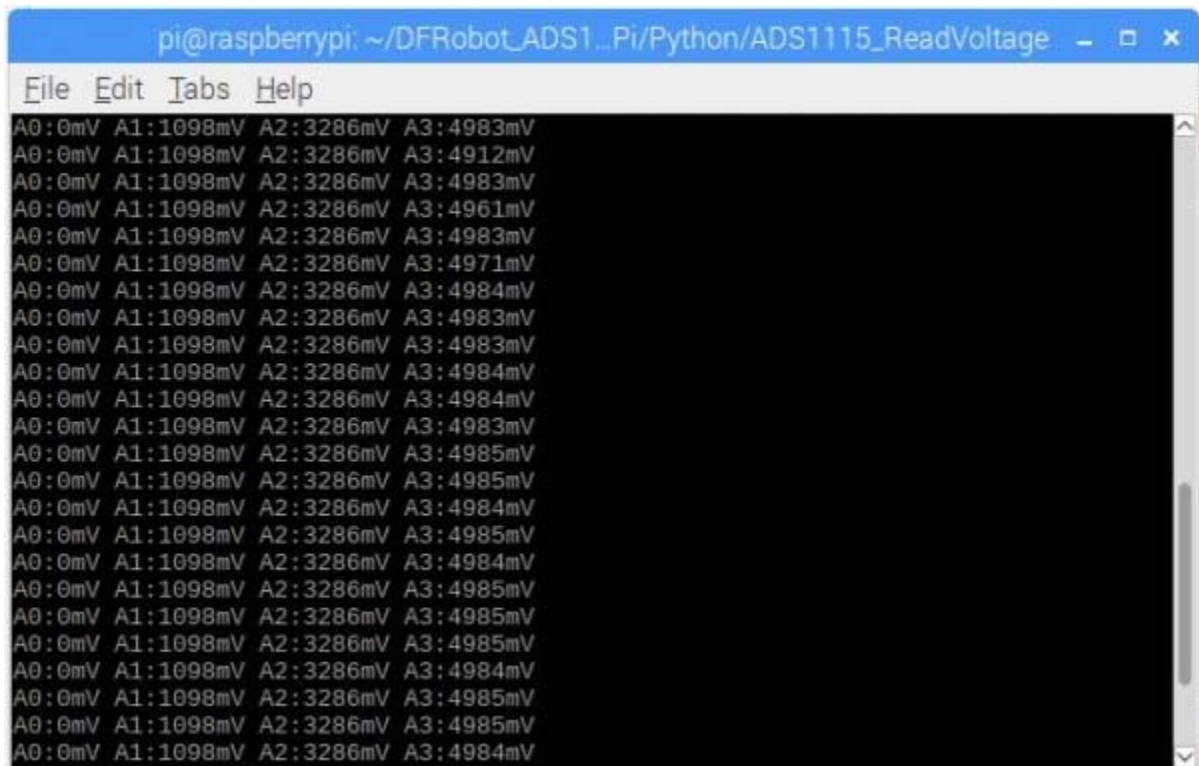

```
pi@raspberrypi: ~/DFRobot_ADS1...Pi/Python/ADS1115_ReadVoltage
File Edit Tabs Help
A0:0mV A1:1098mV A2:3286mV A3:4983mV
A0:0mV A1:1098mV A2:3286mV A3:4912mV
A0:0mV A1:1098mV A2:3286mV A3:4983mV
A0:0mV A1:1098mV A2:3286mV A3:4961mV
A0:0mV A1:1098mV A2:3286mV A3:4983mV
A0:0mV A1:1098mV A2:3286mV A3:4971mV
A0:0mV A1:1098mV A2:3286mV A3:4984mV
A0:0mV A1:1098mV A2:3286mV A3:4983mV
A0:0mV A1:1098mV A2:3286mV A3:4983mV
A0:0mV A1:1098mV A2:3286mV A3:4984mV
A0:0mV A1:1098mV A2:3286mV A3:4984mV
A0:0mV A1:1098mV A2:3286mV A3:4983mV
A0:0mV A1:1098mV A2:3286mV A3:4985mV
A0:0mV A1:1098mV A2:3286mV A3:4985mV
A0:0mV A1:1098mV A2:3286mV A3:4984mV
A0:0mV A1:1098mV A2:3286mV A3:4985mV
A0:0mV A1:1098mV A2:3286mV A3:4985mV
A0:0mV A1:1098mV A2:3286mV A3:4985mV
A0:0mV A1:1098mV A2:3286mV A3:4984mV
A0:0mV A1:1098mV A2:3286mV A3:4985mV
A0:0mV A1:1098mV A2:3286mV A3:4985mV
A0:0mV A1:1098mV A2:3286mV A3:4984mV
```