

FEATURES

- Single-channel, 1024-position resolution
- 10 k Ω nominal resistance
- 50-times programmable (50-TP) wiper memory
- Rheostat mode temperature coefficient: 35 ppm/ $^{\circ}$ C
- 2.7 V to 5.5 V single-supply operation
- ± 2.5 V to ± 2.75 V dual-supply operation for ac or bipolar operations
- SPI-compatible interface
- Wiper setting and memory readback
- Power on refreshed from memory
- Resistor tolerance stored in memory
- Thin LFCSP 10-lead, 3 mm \times 3 mm \times 0.8 mm package
- Compact MSOP, 10-lead, 3 mm \times 4.9 mm \times 1.1 mm package

APPLICATIONS

- Mechanical rheostat replacements
- Op-amp: variable gain control
- Instrumentation: gain, offset adjustment
- Programmable voltage-to-current conversions
- Programmable filters, delays, time constants
- Programmable power supply
- Sensor calibration

GENERAL DESCRIPTION

The AD5174 is a single-channel, 1024-position digital rheostat that combines industry leading variable resistor performance with nonvolatile memory (NVM) in a compact package.

This device supports both dual-supply operation at ± 2.5 V to ± 2.75 V and single-supply operation at 2.7 V to 5.5 V and offers 50-times programmable (50-TP) memory.

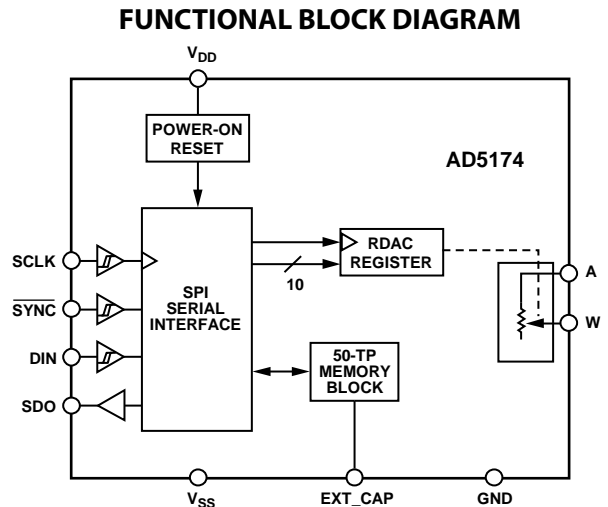

Figure 1.

The AD5174 device wiper settings are controllable through the SPI digital interface. Unlimited adjustments are allowed before programming the resistance value into the 50-TP memory. The AD5174 does not require any external voltage supply to facilitate fuse blow and there are 50 opportunities for permanent programming. During 50-TP activation, a permanent blow fuse command freezes the resistance position (analogous to placing epoxy on a mechanical rheostat).

The AD5174 is available in a 3 mm \times 3mm 10-lead LFCSP package and in a 10-lead MSOP package. The part is guaranteed to operate over the extended industrial temperature range of -40° C to $+125^{\circ}$ C.

Rev. B

Information furnished by Analog Devices is believed to be accurate and reliable. However, no responsibility is assumed by Analog Devices for its use, nor for any infringements of patents or other rights of third parties that may result from its use. Specifications subject to change without notice. No license is granted by implication or otherwise under any patent or patent rights of Analog Devices. Trademarks and registered trademarks are the property of their respective owners.

AD5174* PRODUCT PAGE QUICK LINKS

Last Content Update: 02/23/2017

COMPARABLE PARTS

View a parametric search of comparable parts.

DOCUMENTATION

Application Notes

- AN-1291: Digital Potentiometers: Frequently Asked Questions

Data Sheet

- AD5174: Single-Channel, 1024-Position, Digital Rheostat with SPI Interface and 50-TP Memory Data Sheet

User Guides

- UG-094: Evaluation Board for 10-Bit, Serial Input, High Precision Digital Rheostats

DESIGN RESOURCES

- AD5174 Material Declaration
- PCN-PDN Information
- Quality And Reliability
- Symbols and Footprints

DISCUSSIONS

View all AD5174 EngineerZone Discussions.

SAMPLE AND BUY

Visit the product page to see pricing options.

TECHNICAL SUPPORT

Submit a technical question or find your regional support number.

DOCUMENT FEEDBACK

Submit feedback for this data sheet.

TABLE OF CONTENTS

Features	1	Shift Register	12
Applications	1	RDAC Register.....	12
Functional Block Diagram	1	50-TP Memory Block	12
General Description	1	Write Protection	12
Revision History	2	RDAC and 50-TP Read Operation	13
Specifications.....	3	Shutdown Mode	14
Electrical Characteristics	3	Reset	14
Interface Timing Specifications.....	4	SDO Pin and Daisy-Chain Operation.....	15
Absolute Maximum Ratings.....	6	RDAC Architecture.....	16
Thermal Resistance	6	Programming the Variable Resistor.....	16
ESD Caution.....	6	EXT_CAP Capacitor.....	17
Pin Configuration and Function Descriptions.....	7	Terminal Voltage Operating Range	17
Typical Performance Characteristics	8	Power-Up Sequence	17
Test Circuits.....	11	Outline Dimensions.....	18
Theory of Operation	12	Ordering Guide	18
Serial Data Interface.....	12		

REVISION HISTORY

12/10—Rev. A to Rev. B

Changes to SDO Pin Description.....	7
Changes to SDO Pin and Daisy-Chain Operation Section.....	15

7/10—Rev. 0 to Rev. A

Changes to Daisy-Chain Operation Section including Changing Title to SDO Pin and Daisy-Chain Operation Section	15
Added Table 11	15
Changes to Ordering Guide	18

3/10—Revision 0: Initial Version

SPECIFICATIONS

ELECTRICAL CHARACTERISTICS

$V_{DD} = 2.7\text{ V to }5.5\text{ V}$, $V_{SS} = 0\text{ V}$; $V_{DD} = 2.5\text{ V to }2.75\text{ V}$, $V_{SS} = -2.5\text{ V to }-2.75\text{ V}$; $-40^{\circ}\text{C} < T_A < 125^{\circ}\text{C}$, unless otherwise noted.

Table 1.

Parameter	Symbol	Test Conditions/Comments	Min	Typ ¹	Max	Unit
DC CHARACTERISTICS—RHEOSTAT MODE						
Resolution			10			Bits
Resistor Integral Nonlinearity ^{2,3}	R-INL	$ V_{DD} - V_{SS} = 3.6\text{ V to }5.5\text{ V}$	-1		+1	LSB
		$ V_{DD} - V_{SS} = 3.3\text{ V to }3.6\text{ V}$	-1		+1.5	LSB
		$ V_{DD} - V_{SS} = 2.7\text{ V to }3.3\text{ V}$	-2.5		+2.5	LSB
Resistor Differential Nonlinearity ²	R-DNL		-1		+1	LSB
Nominal Resistor Tolerance				±15		%
Resistance Temperature Coefficient ^{4,5}		Code = full scale		35		ppm/°C
Wiper Resistance		Code = zero scale		35	70	Ω
RESISTOR TERMINALS						
Terminal Voltage Range ^{4,6}	V_{TERM}		V_{SS}		V_{DD}	V
Capacitance A ⁴		f = 1 MHz, measured to GND, code = half scale		90		pF
Capacitance W ⁴		f = 1 MHz, measured to GND, code = half scale		40		pF
Common-Mode Leakage Current ⁴		$V_A = V_W$			50	nA
DIGITAL INPUTS						
Input Logic ⁴						
High	V_{INH}		2.0			V
Low	V_{INL}				0.8	V
Input Current	I_{IN}			±1		μA
Input Capacitance ⁴	C_{IN}			5		pF
DIGITAL OUTPUT						
Output Voltage ⁴						
High	V_{OH}	$R_{PULL_UP} = 2.2\text{ k}\Omega\text{ to }V_{DD}$	$V_{DD} - 0.1$			V
Low	V_{OL}	$R_{PULL_UP} = 2.2\text{ k}\Omega\text{ to }V_{DD}$ $V_{DD} = 2.7\text{ V to }5.5\text{ V}, V_{SS} = 0\text{ V}$ $V_{DD} = 2.5\text{ V to }2.75\text{ V}, V_{SS} = -2.5\text{ V to }-2.75\text{ V}$			0.4	V
					0.6	V
Tristate Leakage Current			-1		+1	μA
Output Capacitance ⁴				5		pF
POWER SUPPLIES						
Single-Supply Power Range		$V_{SS} = 0\text{ V}$	2.7		5.5	V
Dual-Supply Power Range			±2.5		±2.75	V
Supply Current						
Positive	I_{DD}				1	μA
Negative	I_{SS}		-1			μA
50-TP Store Current ^{4,7}						
Positive	$I_{DD_OTP_STORE}$			4		mA
Negative	$I_{SS_OTP_STORE}$			-4		mA
50-TP Read Current ^{4,8}						
Positive	$I_{DD_OTP_READ}$				500	μA
Negative	$I_{SS_OTP_READ}$		-500			μA
Power Dissipation ⁹	P_{DISS}	$V_{IH} = V_{DD}\text{ or }V_{IL} = \text{GND}$			5.5	μW
Power Supply Rejection Ratio ⁴	PSRR	$\Delta V_{DD}/\Delta V_{SS} = \pm 5\text{ V} \pm 10\%$	-50	-55		dB

AD5174

Parameter	Symbol	Test Conditions/Comments	Min	Typ ¹	Max	Unit
DYNAMIC CHARACTERISTICS ^{4, 10}						
Bandwidth		-3 dB, $R_{AW} = 5\text{ k}\Omega$, Terminal W, see Figure 24		700		kHz
Total Harmonic Distortion		$V_A = 1\text{ V rms}$, $f = 1\text{ kHz}$, $R_{AW} = 5\text{ k}\Omega$		-90		dB
Resistor Noise Density		$R_{WB} = 5\text{ k}\Omega$, $T_A = 25^\circ\text{C}$, $f = 10\text{ kHz}$		13		nV/ $\sqrt{\text{Hz}}$

¹ Typical specifications represent average readings at 25°C, $V_{DD} = 5\text{ V}$, and $V_{SS} = 0\text{ V}$.

² Resistor position nonlinearity error (R-INL) is the deviation from an ideal value measured between the maximum resistance and the minimum resistance wiper positions. R-DNL measures the relative step change from the ideal between successive tap positions.

³ The maximum current in each code is defined by $I_{AW} = (V_{DD} - 1)/R_{AW}$.

⁴ Guaranteed by design and not subject to production test.

⁵ See Figure 9 for more details.

⁶ Resistor Terminal A and Resistor Terminal W have no limitations on polarity with respect to each other. Dual-supply operation enables ground referenced bipolar signal adjustment.

⁷ Different from operating current; the supply current for the fuse program lasts approximately 55 ms.

⁸ Different from operating current; the supply current for the fuse read lasts approximately 500 ns.

⁹ P_{DISS} is calculated from $(I_{DD} \times V_{DD}) + (I_{SS} \times V_{SS})$.

¹⁰ All dynamic characteristics use $V_{DD} = +2.5\text{ V}$, $V_{SS} = -2.5\text{ V}$.

INTERFACE TIMING SPECIFICATIONS

$V_{DD} = 2.7\text{ V}$ to 5.5 V , $V_{SS} = 0\text{ V}$; $V_{DD} = 2.5\text{ V}$, $V_{SS} = -2.5\text{ V}$; all specifications T_{MIN} to T_{MAX} , unless otherwise noted.

Table 2.

Parameter	Limit ¹	Unit	Test Conditions/Comments
t_1^2	20	ns min	SCLK cycle time
t_2	10	ns min	SCLK high time
t_3	10	ns min	SCLK low time
t_4	15	ns min	$\overline{\text{SYNC}}$ to SCLK falling edge setup time
t_5	5	ns min	Data setup time
t_6	5	ns min	Data hold time
t_7	1	ns min	SCLK falling edge to $\overline{\text{SYNC}}$ rising edge
t_8^3	400	ns min	Minimum $\overline{\text{SYNC}}$ high time
t_9	15	ns min	$\overline{\text{SYNC}}$ rising edge to next SCLK fall ignored
t_{10}^4	450	ns max	SCLK rising edge to SDO valid
$t_{\text{MEMORY_READ}}$	6	$\mu\text{s max}$	Memory readback execute time
$t_{\text{MEMORY_PROGRAM}}$	350	ms max	Memory program time
t_{RESET}	600	$\mu\text{s max}$	Reset OTP restore time
$t_{\text{POWER-UP}}^5$	2	ms max	Power-on 50-TP restore time

¹ All input signals are specified with $t_r = t_f = 1\text{ ns/V}$ (10% to 90% of V_{DD}) and timed from a voltage level of $(V_{IL} + V_{IH})/2$.

² Maximum SCLK frequency is 50 MHz.

³ Refer to $t_{\text{MEMORY_READ}}$ and $t_{\text{MEMORY_PROGRAM}}$ for memory commands operations.

⁴ $R_{\text{PULL_UP}} = 2.2\text{ k}\Omega$ to V_{DD} with a capacitance load of 168 pF.

⁵ Maximum time after $V_{DD} - V_{SS}$ is equal to 2.5 V.

Shift Register and Timing Diagrams

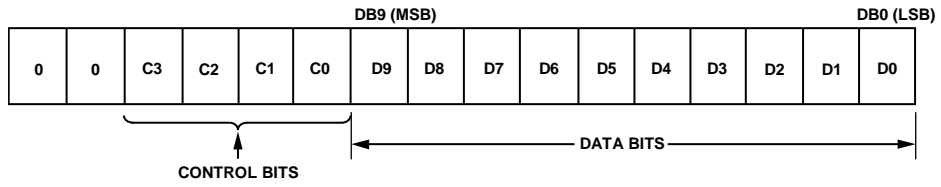

Figure 2. Shift Register Content

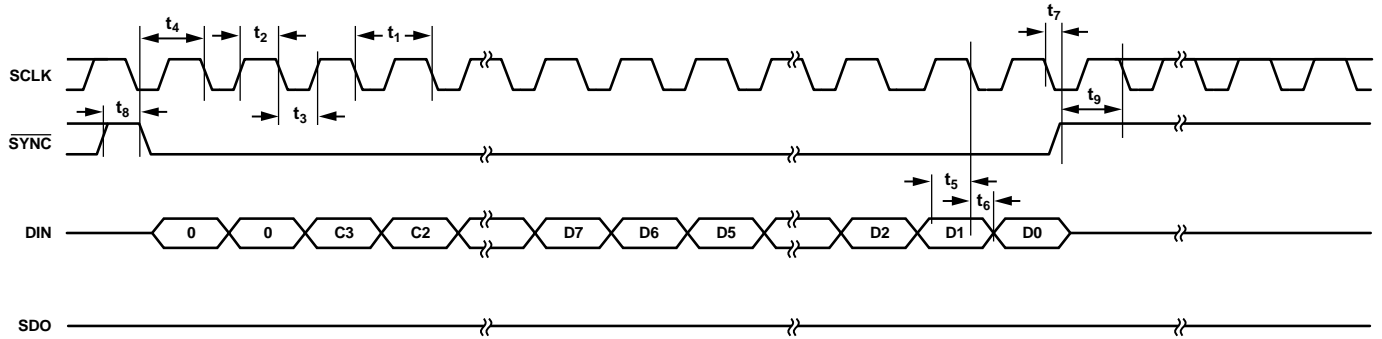

Figure 3. Write Timing Diagram, CPOL=0, CPHA = 1

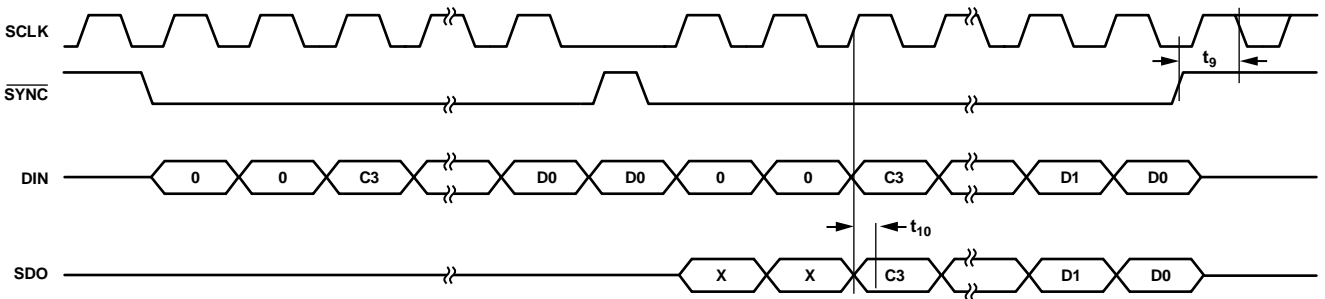

Figure 4. Read Timing Diagram, CPOL=0, CPHA = 1

ABSOLUTE MAXIMUM RATINGS

T_A = 25°C, unless otherwise noted.

Table 3.

Parameter	Rating
V _{DD} to GND	−0.3 V to +7.0 V
V _{SS} to GND	+0.3 V to −7.0 V
V _{DD} to V _{SS}	7 V
V _A , V _W to GND	V _{SS} − 0.3 V, V _{DD} + 0.3 V
Digital Input and Output Voltage to GND	−0.3 V to V _{DD} + 0.3 V
EXT_CAP to V _{SS}	7 V
I _A , I _W	
Pulsed ¹	
Frequency > 10 kHz	±6 mA/d ²
Frequency ≤ 10 kHz	±6 mA/√d ²
Continuous	±6 mA
Operating Temperature Range ³	−40°C to +125°C
Maximum Junction Temperature (T _J Maximum)	150°C
Storage Temperature Range	−65°C to +150°C
Reflow Soldering	
Peak Temperature	260°C
Time at Peak Temperature	20 sec to 40 sec
Package Power Dissipation	(T _J max − T _A)/θ _{JA}

¹ Maximum terminal current is bounded by the maximum current handling of the switches, maximum power dissipation of the package, and maximum applied voltage across any two of the A and W terminals at a given resistance.

² Pulse duty factor.

³ Includes programming of 50-TP memory.

Stresses above those listed under Absolute Maximum Ratings may cause permanent damage to the device. This is a stress rating only and functional operation of the device at these or any other conditions above those indicated in the operational section of this specification is not implied. Exposure to absolute maximum rating conditions for extended periods may affect device reliability.

THERMAL RESISTANCE

θ_{JA} is defined by JEDEC specification JESD-51 and the value is dependent on the test board and test environment.

Table 4. Thermal Resistance

Package Type	θ _{JA} ¹	θ _{JC}	Unit
10-Lead LFCSP	50	3	°C/W
10-Lead MSOP	135	N/A	°C/W

¹ JEDEC 2S2P test board, still air (0 m/sec airflow).

ESD CAUTION



ESD (electrostatic discharge) sensitive device. Charged devices and circuit boards can discharge without detection. Although this product features patented or proprietary protection circuitry, damage may occur on devices subjected to high energy ESD. Therefore, proper ESD precautions should be taken to avoid performance degradation or loss of functionality.

PIN CONFIGURATION AND FUNCTION DESCRIPTIONS

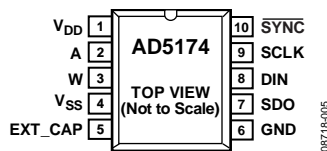

Figure 5. MSOP Pin Configuration

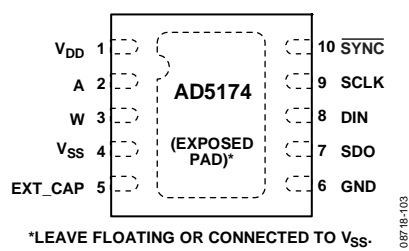

Figure 6. LFCSP Pin Configuration

Table 5. Pin Function Descriptions

Pin No.	Mnemonic	Description
1	V _{DD}	Positive Power Supply. Decouple this pin with 0.1 μ F ceramic capacitors and 10 μ F capacitors.
2	A	Terminal A of RDAC. $V_{SS} \leq V_A \leq V_{DD}$.
3	W	Wiper Terminal of RDAC. $V_{SS} \leq V_W \leq V_{DD}$.
4	V _{SS}	Negative Supply. Connect to 0 V for single-supply applications. Decouple this pin with 0.1 μ F ceramic capacitors and 10 μ F capacitors.
5	EXT_CAP	External Capacitor. Connect a 1 μ F capacitor between EXT_CAP and V _{SS} . This capacitor must have a voltage rating of ≥ 7 V.
6	GND	Ground Pin, Logic Ground Reference.
7	SDO	Serial Data Output. This pin can be used to clock data from the shift register in daisy-chain mode or in readback mode. This open-drain output requires an external pull-up resistor even if it is not use.
8	DIN	Serial Data Line. This pin is used in conjunction with the SCLK line to clock data into or out of the 16-bit input register.
9	SCLK	Serial Clock Input. Data is clocked into the shift register on the falling edge of the serial clock input. Data can be transferred at rates of up to 50 MHz.
10	$\overline{\text{SYNC}}$	Falling Edge Synchronization Signal. This is the frame synchronization signal for the input data. When $\overline{\text{SYNC}}$ goes low, it enables the shift register and data is transferred in on the falling edges of the subsequent clocks. The selected register is updated on the rising edge of $\overline{\text{SYNC}}$ following the 16 th clock cycle. If $\overline{\text{SYNC}}$ is taken high before the 16 th clock cycle, the rising edge of $\overline{\text{SYNC}}$ acts as an interrupt, and the write sequence is ignored by the RDAC.
EPAD	Exposed Pad	Leave floating or connected to V _{SS}

TYPICAL PERFORMANCE CHARACTERISTICS

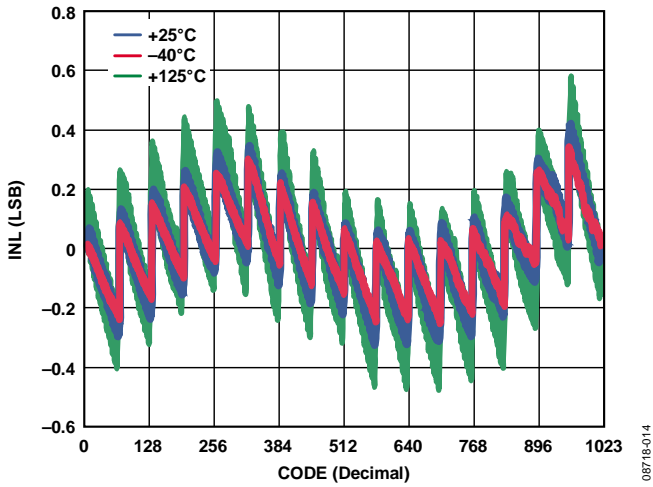

Figure 7. R-INL vs. Code vs. Temperature

08718-014

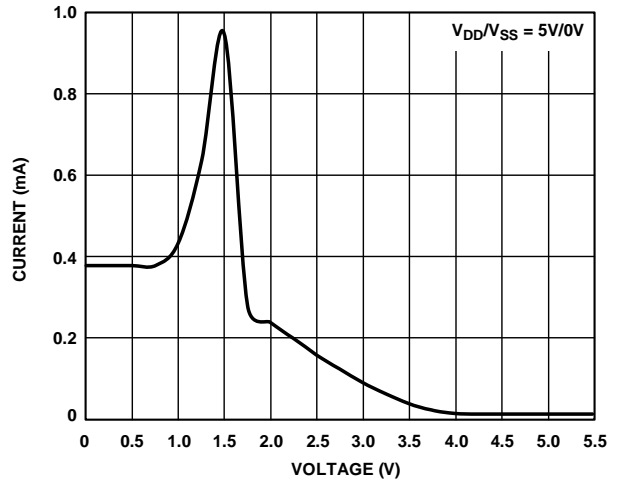

Figure 10. Supply Current (I_{DD}) vs. Digital Input Voltage

08718-023

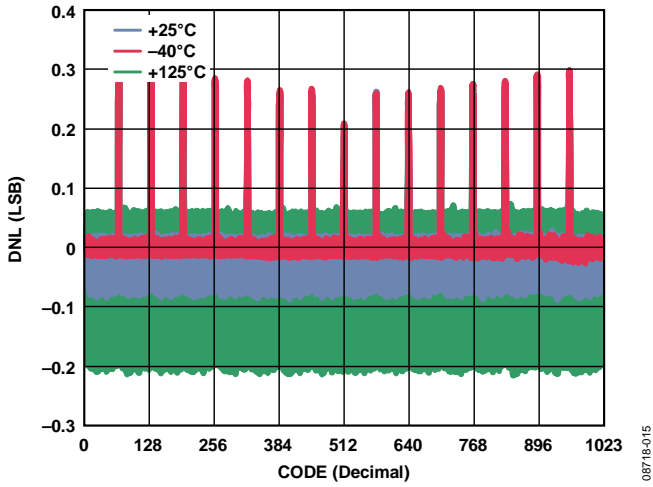

Figure 8. R-DNL vs. Code vs. Temperature

08718-015

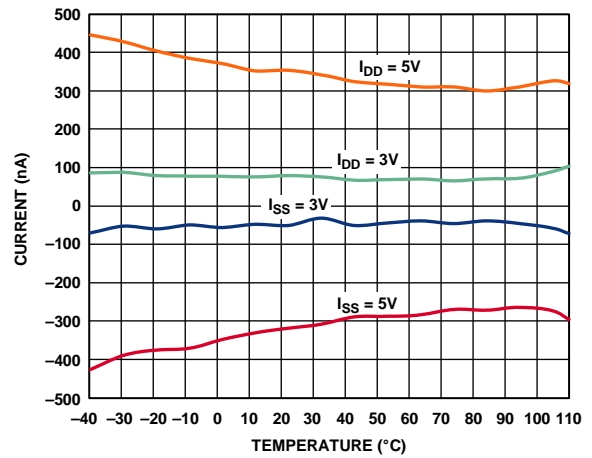

Figure 11. Supply Current (I_{DD} , I_{SS}) vs. Temperature

08718-018

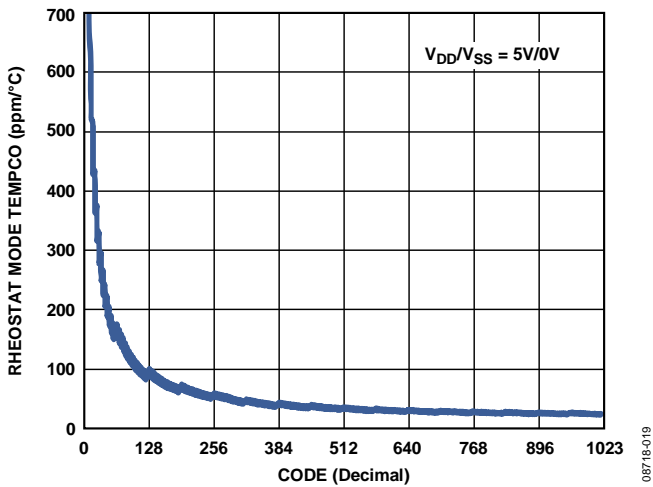

Figure 9. Tempco $\Delta R_{WW}/\Delta T$ vs. Code

08718-019

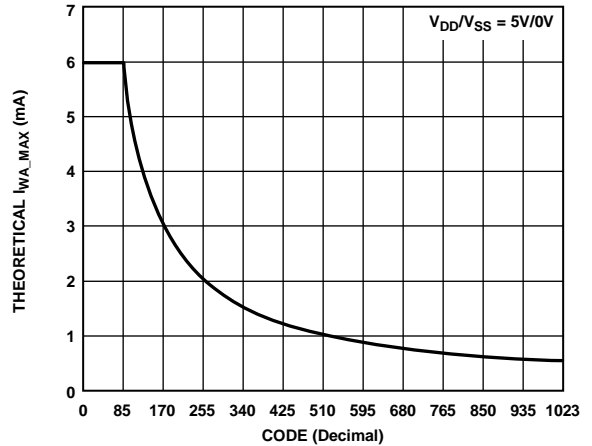

Figure 12. Theoretical Maximum Current vs. Code

08718-028

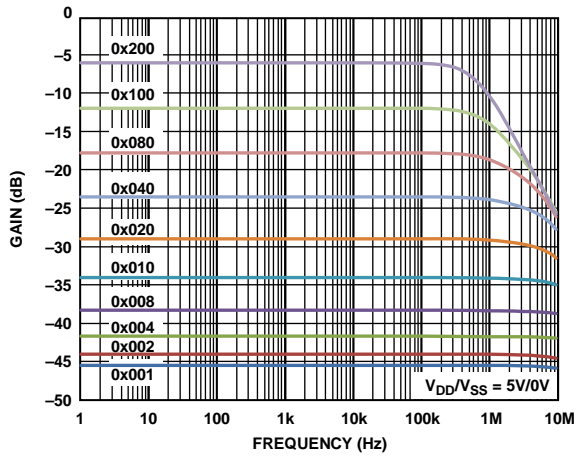

Figure 13. Bandwidth vs. Frequency vs. Code

08718-031

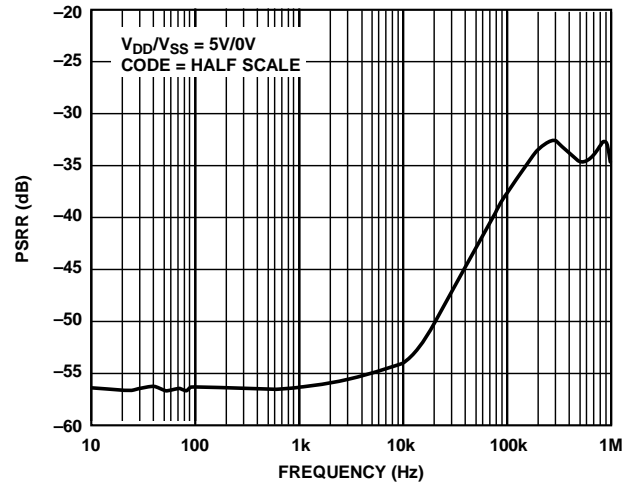

Figure 16. PSRR vs. Frequency

08718-024

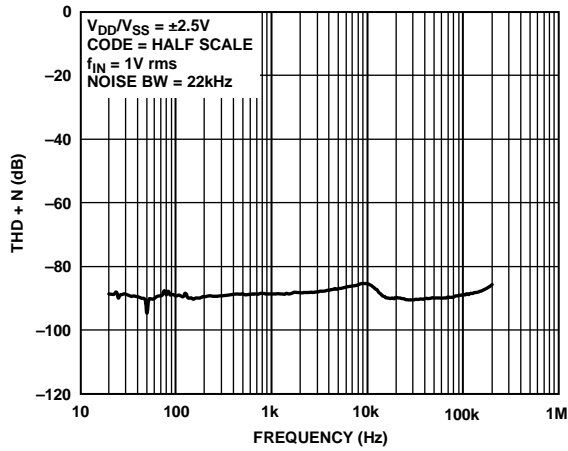

Figure 14. THD + N vs. Frequency

08718-039

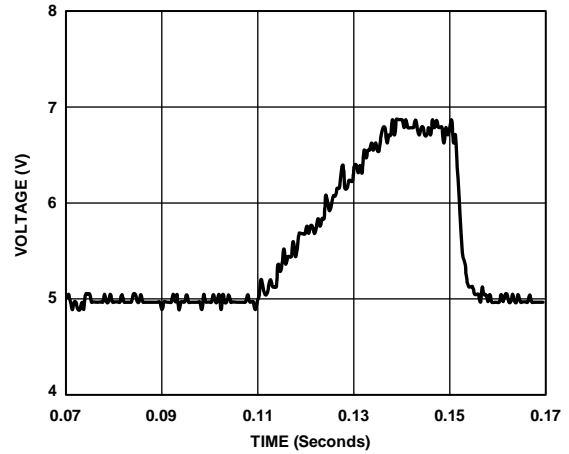

Figure 17. V_{EXT_CAP} Waveform While Writing Fuse

08718-029

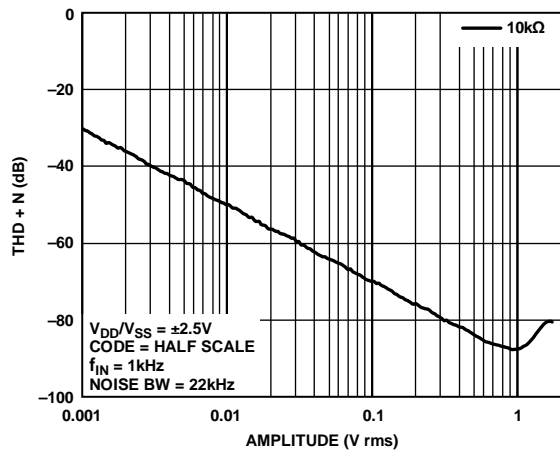

Figure 15. THD + N vs. Amplitude

08718-028

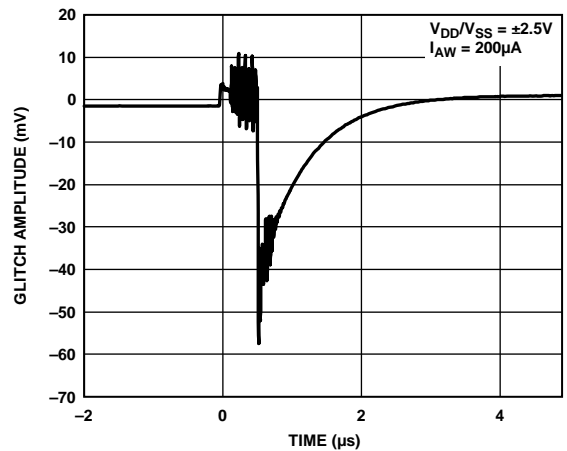

Figure 18. Maximum Glitch Energy

08718-102

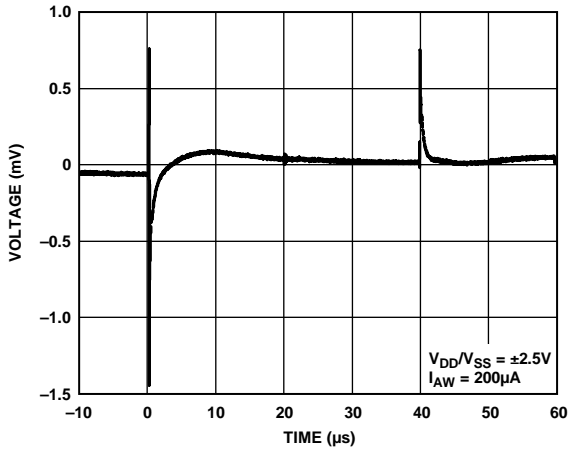

Figure 19. Digital Feedthrough

08718-100

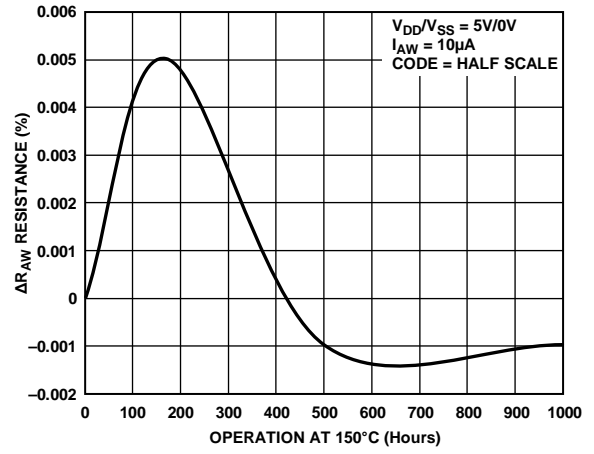

Figure 20. Long-Term Drift Accelerated Average by Burn-In

08718-101

TEST CIRCUITS

Figure 21 to Figure 25 define the test conditions used in the Specifications section.

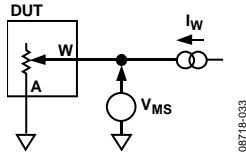

Figure 21. Resistor Position Nonlinearity Error (Rheostat Operation; R-INL, R-DNL)

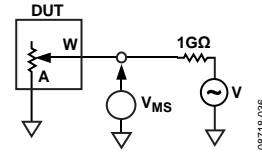

Figure 24. Gain vs. Frequency

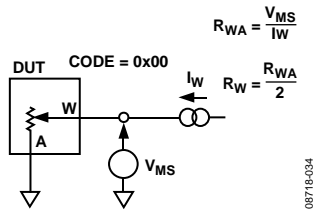

Figure 22. Wiper Resistance

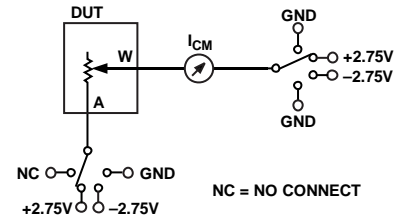

Figure 25. Common Leakage Current

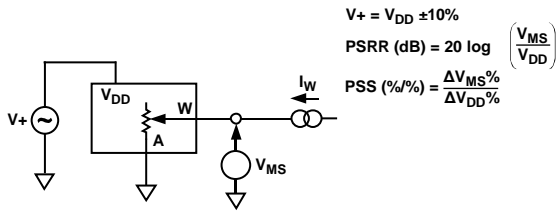

Figure 23. Power Supply Sensitivity (PSS, PSRR)

08718-035

08718-037

THEORY OF OPERATION

The AD5174 is designed to operate as a true variable resistor for analog signals within the terminal voltage range of $V_{SS} < V_{TERM} < V_{DD}$. The RDAC register contents determine the resistor wiper position. The RDAC register acts as a scratchpad register, which allows unlimited changes of resistance settings. The RDAC register can be programmed with any position setting by using the SPI interface. When a desirable wiper position is found, this value can be stored in a 50-TP memory register. Thereafter, the wiper position is always restored to that position for subsequent power-ups. The storing of 50-TP data takes approximately 350 ms; during this time, the AD5174 locks to prevent any changes from taking place.

The AD5174 also features a patented 1% end-to-end resistor tolerance. This simplifies precision, rheostat mode, and open-loop applications where knowledge of absolute resistance is critical.

SERIAL DATA INTERFACE

The AD5174 contains a serial interface ($\overline{\text{SYNC}}$, SCLK, DIN, and SDO) that is compatible with SPI interface standards, as well as most DSPs. This device allows writing of data via the serial interface to every register.

SHIFT REGISTER

The shift register is 16 bits wide, as shown in Figure 2. The 16-bit word consists of two unused bits, which should be set to 0, followed by four control bits and 10 RDAC data bits. Data is loaded MSB first (Bit D9). The four control bits determine the function of the software command as listed in Table 6. Figure 3 shows a timing diagram of a typical AD5174 write sequence.

The write sequence begins by bringing the $\overline{\text{SYNC}}$ line low. The $\overline{\text{SYNC}}$ pin must be held low until the complete data-word is loaded from the DIN pin. When $\overline{\text{SYNC}}$ returns high, the serial data-word is decoded according to the instructions in Table 6. The command bits (Cx) control the operation of the digital potentiometer. The data bits (Dx) are the values that are loaded into the decoded register. The AD5174 has an internal counter that counts a multiple of 16 bits (a frame) for proper operation. For example, AD5174 works with a 32-bit word but does not work properly with a 31-bit or 33-bit word. The AD5174 does not require a continuous SCLK when $\overline{\text{SYNC}}$ is high.

To minimize power consumption in the digital input buffers, operate all serial interface pins close to the V_{DD} supply rails.

RDAC REGISTER

The RDAC register directly controls the position of the digital rheostat wiper. For example, when the RDAC register is loaded with all 0s, the wiper is connected to Terminal A of the variable resistor. The RDAC register is a standard logic register, and there is no restriction on the number of changes allowed. The basic mode of setting the variable resistor wiper position (programming the RDAC register) is accomplished by loading the serial data input register with Command 1 (see Table 6) and with the desired wiper position data.

50-TP MEMORY BLOCK

The AD5174 contains an array of 50-TP programmable memory registers, which allow the wiper position to be programmed up to 50 times. Table 10 shows the memory map. When the desired wiper position is determined, the user can load the serial data input register with Command 3 (see Table 6), which stores the wiper position data in a 50-TP memory register. The first address to be programmed is Location 0x01 (see Table 10); the AD5174 increments the 50-TP memory address for each subsequent program until the memory is full. Programming data to 50-TP consumes approximately 4 mA for 55 ms, and takes approximately 350 ms to complete, during which time the shift register locks to prevent any changes from occurring. Bit C2 of the control register can be polled to verify that the fuse program command was completed properly. No change in supply voltage is required to program the 50-TP memory; however, a 1 μF capacitor on the EXT_CAP pin is required (see Figure 28). Prior to 50-TP activation, the AD5174 presets to midscale on power-up.

WRITE PROTECTION

At power-up, the serial data input register write commands for both the RDAC register and the 50-TP memory registers are disabled. The RDAC write protect bit, C1, of the control register (see Table 8 and Table 9) is set to 0 by default. This disables any change of the RDAC register content regardless of the software commands, except that the RDAC register can be refreshed from the 50-TP memory using the software reset, Command 4 (see Table 6). To enable programming of the RDAC register, the write protect bit (Bit C1), of the control register must first be programmed by loading the serial data input register with Command 7. To enable programming of the 50-TP memory, the program enable bit (Bit C0) of the control register, which is set to 0 by default, must first be set to 1.

RDAC AND 50-TP READ OPERATION

A serial data output SDO pin is available for readback of the internal RDAC register or 50-TP memory contents. The contents of the RDAC register can be read back through SDO by using Command 2 (see Table 6). Data from the RDAC register is clocked out of the SDO pin during the last 10 clocks of the next SPI operation.

It is possible to read back the contents of any of the 50-TP memory registers through SDO by using Command 5. The lower six LSB bits, D5 to D0 of the data byte, select which memory location is to be read back, as shown in Table 10.

Data from the selected memory location is clocked out of the SDO pin during the next SPI operation. A binary encoded version address of the most recently programmed wiper memory location can be read back using Command 6 (see Table 6). This can be used to monitor the spare memory status of the 50-TP memory block.

Table 7 provides a sample listing for the sequence of serial data input (DIN) words with the serial data output appearing at the SDO pin in hexadecimal format for a write and read to both the RDAC register and the 50-TP memory (Memory Location 20).

Table 6. Command Operation Truth Table

Command Number	Command[DB13:DB10]				Data[DB9:DB0] ¹										Operation
	C3	C2	C1	C0	D9	D8	D7	D6	D5	D4	D3	D2	D1	D0	
0	0	0	0	0	X	X	X	X	X	X	X	X	X	X	NOP: do nothing.
1	0	0	0	1	D9	D8	D7	D6	D5	D4	D3	D2	D1	D0	Write contents of serial register data to RDAC.
2	0	0	1	0	X	X	X	X	X	X	X	X	X	X	Read contents of RDAC wiper register.
3	0	0	1	1	X	X	X	X	X	X	X	X	X	X	Store wiper setting: store RDAC setting to 50-TP.
4	0	1	0	0	X	X	X	X	X	X	X	X	X	X	Software reset: refresh RDAC with last 50-TP memory stored value.
5 ²	0	1	0	1	X	X	X	X	D5	D4	D3	D2	D1	D0	Read contents of 50-TP from SDO output in the next frame.
6	0	1	1	0	X	X	X	X	X	X	X	X	X	X	Read address of last 50-TP programmed memory location.
7 ³	0	1	1	1	X	X	X	X	X	X	X	X	D1	D0	Write contents of serial register data to control register.
8	1	0	0	0	X	X	X	X	X	X	X	X	X	X	Read contents of control register.
9	1	0	0	1	X	X	X	X	X	X	X	X	X	D0	Software shutdown. D0 = 0; normal mode. D0 = 1; device placed in shutdown mode.

¹ X is don't care.

² See Table 10 for 50-TP memory map.

³ See Table 9 for bit details.

AD5174

SHUTDOWN MODE

The AD5174 can be shut down by executing the software shutdown command, Command 9 (see Table 6), and setting the LSB to 1. This feature places the RDAC in a zero-power-consumption state where Terminal A is open circuited and the wiper terminal, W, remains connected. It is possible to execute any command from Table 6 while the AD5174 is in shutdown mode. The parts can be taken out of shutdown mode by executing Command 9 and setting the LSB to 0 or by a software reset, Command 4 (see Table 6).

RESET

The AD5174 can be reset through software by executing Command 4 (see Table 6). The reset command loads the RDAC register with the contents of the most recently programmed 50-TP memory location. The RDAC register loads with midscale if no 50-TP memory location has been previously programmed.

Table 7. Write and Read to RDAC and 50-TP Memory

DIN	SDO ¹	Action
0x1C03	0xFFFF	Enable update of the wiper position and the 50-TP memory contents through the digital interface.
0x0500	0x1C03	Write 0x100 to the RDAC register; wiper moves to ¼ full-scale position.
0x0800	0x0500	Prepares data read from RDAC register.
0x0C00	0x100	Stores RDAC register content into the 50-TP memory. A 16-bit word appears out of SDO, where the last 10 bits contain the contents of the RDAC register (0x100).
0x1800	0x0C00	Prepares data read of the last programmed 50-TP memory monitor location.
0x0000	0xFF19	NOP Instruction 0 sends a 16-bit word out of SDO, where the six LSBs (that is, last six bits) contain the binary address of the last programmed 50-TP memory location, for example, 0x19 (see Table 10).
0x1419	0x0000	Prepares data read from Memory Location 0x19.
0x2000	0x0100	Prepares data read from the control register. Sends a 16-bit word out of SDO, where the last 10 bits contain the contents of Memory Location 0x19.
0x0000	0xFFFF	NOP Instruction 0 sends a 16-bit word out of SDO, where the last four bits contain the contents of the control register. If Bit C2 = 1, the fuse program command was successful.

¹ X is don't care.

Table 8. Control Register Bit Map

D9	D8	D7	D6	D5	D4	D3	D2	D1	D0
0	0	0	0	0	0	C2	0	C1	C0

Table 9. Control Register Bit Description

Bit Name	Description
C0	50-TP program enable 0 = 50-TP program disabled (default) 1 = enable device for 50-TP program
C1	RDAC register write protect 0 = wiper position frozen to value in 50-TP memory (default) ¹ 1 = allow update of wiper position through digital interface
C2	50-TP memory program success bit 0 = fuse program command was unsuccessful (default) 1 = fuse program command was successful

¹ Wiper position frozen to the last value programmed in the 50-TP memory. The wiper is frozen to midscale if the 50-TP memory has not been previously programmed.

Table 10. Memory Map

Command Number	Data Byte[DB9:DB0] ¹										Register Contents
	D9	D8	D7	D6	D5	D4	D3	D2	D1	D0	
5	X	X	X	0	0	0	0	0	0	0	Reserved
	X	X	X	0	0	0	0	0	0	1	1 st programmed wiper location (0x01)
	X	X	X	0	0	0	0	0	1	0	2 nd programmed wiper location (0x02)
	X	X	X	0	0	0	0	0	1	1	3 rd programmed wiper location (0x03)
	X	X	X	0	0	0	0	1	0	0	4 th programmed wiper location (0x04)

	X	X	X	0	0	0	1	0	1	0	10 th programmed wiper location (0xA)

	X	X	X	0	0	1	0	1	0	0	20 th programmed wiper location (0x14)

	X	X	X	0	0	1	1	1	1	0	30 th programmed wiper location (0x1E)

	X	X	X	0	1	0	1	0	0	0	40 th programmed wiper location (0x28)

	X	X	X	0	1	1	0	0	1	0	50 th programmed wiper location (0x32)
...	
X	X	X	0	1	1	1	0	0	1	MSB resistance tolerance (0x39)	
X	X	X	0	1	1	1	0	1	0	LSB resistance tolerance (0x3A)	

¹ X is don't care.

SDO PIN AND DAISY-CHAIN OPERATION

The serial data output pin (SDO) serves two purposes: it can be used to read the contents of the wiper setting and 50-TP values using Command 2 and Command 5, respectively (see Table 6) or the SDO pin can be used in daisy-chain mode. Data is clocked out of SDO on the rising edge of SCLK. The SDO pin contains an open-drain N-channel FET that requires a pull-up resistor. To place the pin in high impedance and minimize the power dissipation when the pin is used, the 0x8001 data word followed by Command 0 should be sent to the part. Table 11 provides a sample listing for the sequence of the serial data input (DIN). Daisy chaining minimizes the number of port pins required from the controlling IC. As shown in Figure 26, users need to tie the SDO pin of one package to the DIN pin of the next package. Users may need to increase the clock period, because the pull-up resistor and the capacitive loading at the SDO-to-DIN interface may require additional time delay between subsequent devices. When two AD5174 devices are daisy-chained, 32 bits of data are required. The first 16 bits go to U2, and the second 16 bits go to U1.

Table 11. Minimize Power Dissipation at SDO Pin

DIN	SDO ¹	Action
0xXXXX	0xXXXX	Last user command sent to the digipot
0x8001	0xXXXX	Prepares the SDO pin to be placed in high impedance mode
0x0000	High Impedance	The SDO pin is placed in high impedance

¹ X is don't care.

Keep the SYNC pin low until all 32 bits are clocked into their respective serial registers. The SYNC pin is then pulled high to complete the operation.

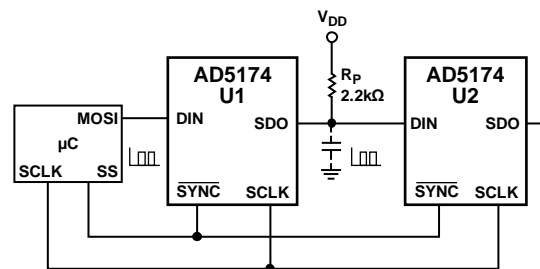

Figure 26. Daisy-Chain Configuration Using SDO

08718-006

RDAC ARCHITECTURE

To achieve optimum performance, Analog Devices, Inc., has patented the RDAC segmentation architecture for all the digital potentiometers. In particular, the AD5174 employs a three-stage segmentation approach as shown in Figure 27. The AD5174 wiper switch is designed with the transmission gate CMOS topology.

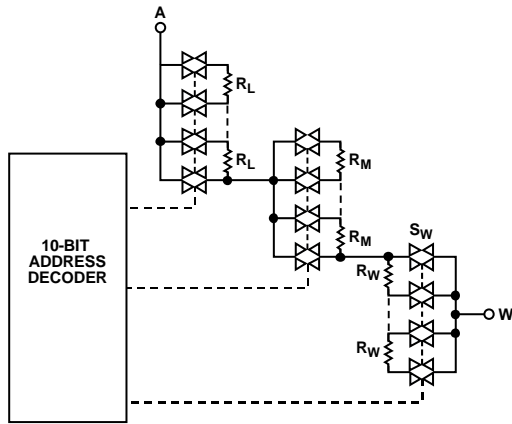

Figure 27. Simplified RDAC Circuit

PROGRAMMING THE VARIABLE RESISTOR

Rheostat Operation

The nominal resistance between Terminal W and Terminal A, R_{WA} , is 10 k Ω and has 1024-tap points accessed by the wiper terminal. The 10-bit data in the RDAC latch is decoded to select one of the 1024 possible wiper settings. As a result, the general equation for determining the digitally programmed output resistance between the W terminal and the A terminal is

$$R_{WA}(D) = \frac{D}{1024} \times R_{WA} \quad (1)$$

where:

D is the decimal equivalent of the binary code loaded in the 10-bit RDAC register.

R_{WA} is the end-to-end resistance.

Table 12. End-to-End Resistance Tolerance Bytes

Memory Map Address	Data Byte ¹									
	DB9	DB8	DB7	DB6	DB5	DB4	DB3	DB2	DB1	DB0
0x39	X	X	Sign	2 ⁶	2 ⁵	2 ⁴	2 ³	2 ²	2 ¹	2 ⁰
0x3A	X	X	2 ⁻¹	2 ⁻²	2 ⁻³	2 ⁻⁴	2 ⁻⁵	2 ⁻⁶	2 ⁻⁷	2 ⁻⁸

¹ X is don't care.

In the zero-scale condition, a finite total wiper resistance of 120 Ω is present. Regardless of which setting the part is operating in, take care to limit the current between Terminal A and Terminal W to the maximum continuous current of ± 6 mA or a pulse current specified in Table 3. Otherwise, degradation or possible destruction of the internal switch contact may occur.

Calculate the Actual End-to-End Resistance

The resistance tolerance is stored in the internal memory during factory testing. The actual end-to-end resistance can, therefore, be calculated (which is valuable for calibration, tolerance matching, and precision applications).

The resistance tolerance (in percentage) is stored in fixed-point format, using a 16-bit sign magnitude binary. The sign bit (0 = negative and 1 = positive) and the integer part is located in Address 0x39 as shown in Table 10. Address 0x3A contains the fractional part as shown in Table 12.

That is, if the data readback from Address 0x39 is 0000001010 and data from Address 0x3A is 0010110000, then the end-to-end resistance can be calculated as follows.

For Memory Location 0x39,

DB[9:8]: XX = don't care

DB[7]: 0 = negative

DB[6:0]: 0001010 = 10

For Memory Location 0x3A,

DB[9:8]: XX = don't care

DB[7:0]: 10110000 = $176 \times 2^{-8} = 0.6875$

Therefore, tolerance = -10.6875% and $R_{WA}(1023) = 8.931$ k Ω .

EXT_CAP CAPACITOR

A 1 μF capacitor to V_{SS} must be connected to the EXT_CAP pin, as shown in Figure 28, on power-up and throughout the operation of the AD5174.

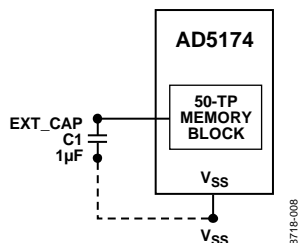

Figure 28. EXT_CAP Hardware Setup

TERMINAL VOLTAGE OPERATING RANGE

The positive V_{DD} and negative V_{SS} power supplies of the AD5174 define the boundary conditions for proper 2-terminal digital resistor operation. Supply signals present on Terminal A and Terminal W that exceed V_{DD} or V_{SS} are clamped by the internal forward-biased diodes (see Figure 29).

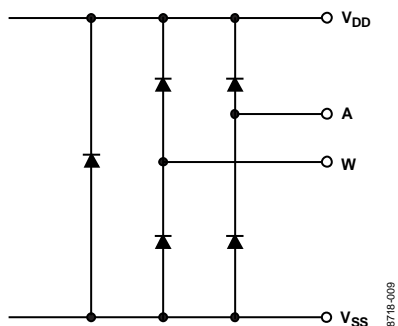

Figure 29. Maximum Terminal Voltages Set by V_{DD} and V_{SS}

The ground pin of the AD5174 is primarily used as a digital ground reference. To minimize the digital ground bounce, join the AD5174 ground terminal remotely to the common ground. The digital input control signals to the AD5174 must be referenced to the device ground pin (GND) and must satisfy the logic level defined in the Specifications section. An internal level shift circuit ensures that the common-mode voltage range of the three terminals extends from V_{SS} to V_{DD} , regardless of the digital input level.

POWER-UP SEQUENCE

Because there are diodes to limit the voltage compliance at Terminal A and Terminal W (see Figure 29), it is important to power V_{DD}/V_{SS} first before applying any voltage to Terminal A and Terminal W; otherwise, the diode is forward-biased such that V_{DD}/V_{SS} are powered unintentionally. The ideal power-up sequence is V_{SS} , GND, V_{DD} , digital inputs, V_A , and V_W . The order of powering V_A , V_W , and the digital inputs is not important as long as they are powered after V_{DD}/V_{SS} .

As soon as V_{DD} is powered, the power-on preset activates, which first sets the RDAC to midscale and then restores the last programmed 50-TP value to the RDAC register.

OUTLINE DIMENSIONS

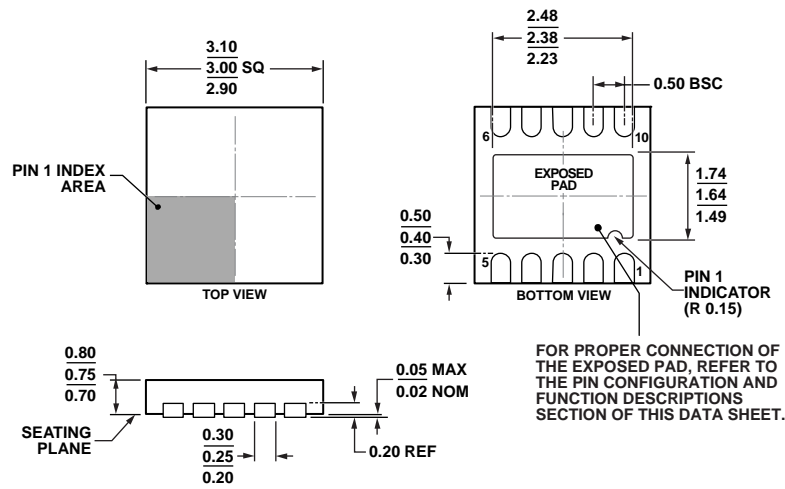
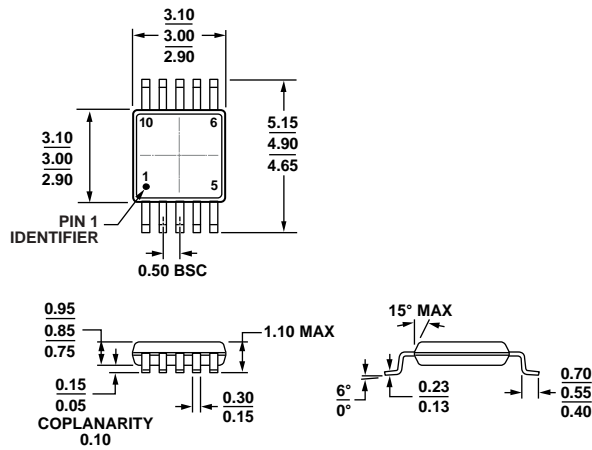

Figure 30. 10-Lead Frame Chip Scale Package [LFCSP_WD]
 3 mm × 3mm Body, Very Thin, Dual Lead
 (CP-10-9)
 Dimensions shown in millimeters

121009-A



COMPLIANT TO JEDEC STANDARDS MO-187-BA
 Figure 31. 10-Lead Mini Small Outline Package [MSOP]
 (RM-10)
 Dimensions shown in millimeters

001709-A

ORDERING GUIDE

Model ¹	R _{AB} (kΩ)	Resolution	Temperature Range	Package Description	Package Option	Branding
AD5174BRMZ-10	10	1,024	-40°C to +125°C	10-Lead MSOP	RM-10	DDT
AD5174BRMZ-10-RL7	10	1,024	-40°C to +125°C	10-Lead MSOP	RM-10	DDT
AD5174BCPZ-10-RL7	10	1,024	-40°C to +125°C	10-Lead LFCSP_WD	CP-10-9	DEF

¹ Z = RoHS Compliant Part.

NOTES

AD5174

NOTES