



MB39C811

Ultra Low Power Buck PMIC Solar/Vibrations Energy Harvesting

The MB39C811 is the high efficient buck (Power Management) DC/DC converter IC which adopts the all-wave bridge rectifier using the low-dissipation and the comparator system. It achieves the energy harvest solution for the energy source of the high output impedance such as the piezoelectric transducer.

It is possible to select from eight preset output voltages and supply up to 100 mA of the output current.

Features

- Quiescent current (No load, Output in regulation): 1.5 μ A
- Quiescent current (VIN = 2.5V UVLO): 550nA
- Integrated Low Loss Full-Wave Bridge Rectifier
- VIN input voltage range: 2.6V to 23V
- Preset output voltage: 1.5V, 1.8V, 2.5V, 3.3V, 3.6V, 4.1V, 4.5V, 5.0V
- Output current: Up to 100mA
- Protection functions
- Shunt for input protection: VIN \geq 21V, Up to 100mA Pull-down
- Over current limit
- I/O power-good detection signal output

Applications

- Light energy harvesting
- Piezoelectric energy harvesting
- Electro-Mechanical energy harvesting
- Wireless HVAC sensor
- Stand-alone nano-power buck regulator



Online Design Simulation Easy DesignSim

This product supports the web-based design simulation tool.
It can easily select external components and can display useful information.
Please access from the following URL.

<http://cypress.transim.com/login.aspx>

Contents

1. **Pin Assignments** 3

2. **Pin Descriptions** 4

3. **Block Diagram** 5

4. **Absolute Maximum Ratings** 6

5. **Recommended Operating Conditions** 7

6. **Electrical Characteristics** 8

6.1 DC Characteristics 8

6.2 Characteristics of Built-in Bridge Rectification Circuit 9

6.3 AC Characteristics (Input/Output Power-Good) 9

7. **Function** 10

7.1 Operational Summary 10

7.2 Start-Up/Shut-Down Sequences 11

7.3 Function Descriptions 11

8. **Typical Application Circuits** 13

9. **Application Notes** 15

10. **Typical Characteristics** 19

11. **Layout for Printed Circuit Board** 25

12. **Usage Precaution** 26

13. **Ordering Information** 26

14. **Marking** 26

15. **Product Labels** 27

16. **Recommended Mounting Conditions** 30

17. **PackageDimensions** 32

18. **Major Changes** 33

Document History 35

1. Pin Assignments

Figure 1. Pin Assignments

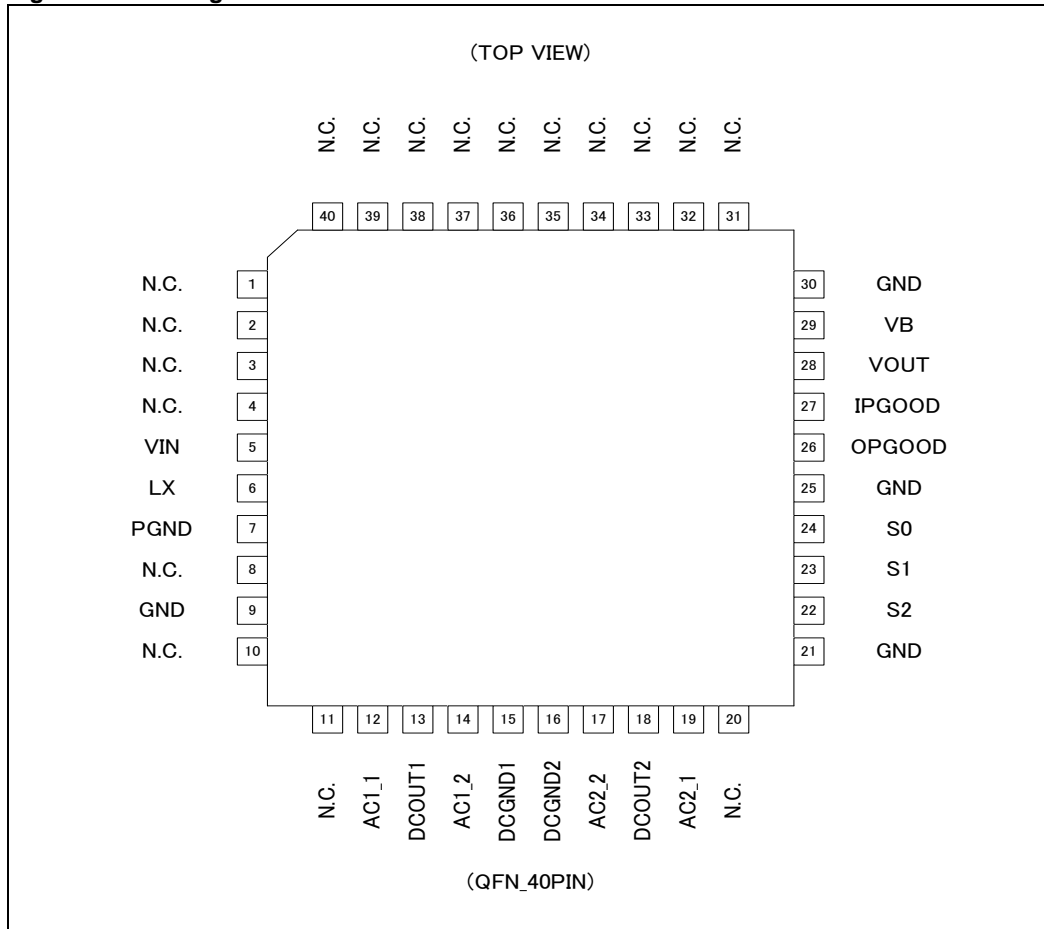

2. Pin Descriptions

Table 1. Pin Descriptions.

Pin No.	Pin Name	I/O	Description
1 to 4	N.C.	-	Non connection pins (Leavethese pins open)
5	VIN	-	DC power supply input pin
6	LX	O	DC/DC output pin
7	PGND	-	PGND pin
8	N.C.	-	Non connection pin (Leavethis pin open)
9	GND	-	GND pin
10,11	N.C.	-	Non connection pins (Leavethese pins open)
12	AC1_1	I	Bridge Rectifier1 AC input pin 1
13	DCOUT1	O	Bridge Rectifier1 DC output pin
14	AC1_2	I	Bridge Rectifier1 AC input pin 2
15	DCGND1	-	GND pin
16	DCGND2	-	GND pin
17	AC2_2	I	Bridge Rectifier2 AC input pin 2
18	DCOUT2	O	Bridge Rectifier2 DC output pin
19	AC2_1	I	Bridge Rectifier2 AC input pin 1
20	N.C.	-	Non connection pin (Leavethis pin open)
21	GND	-	GND pin
22	S2	I	Output voltage select pin 2
23	S1	I	Output voltage select pin 1
24	S0	I	Output voltage select pin 0
25	GND	-	GND pin
26	OPGOOD	O	Output power-good output pin
27	IPGOOD	O	Input power-good output pin
28	VOUT	I	Output voltage feedback pin
29	VB	O	Internal circuit power supply pin
30	GND	-	GND pin
31 to 40	N.C.	-	Non connection pins (Leavethese pins open)

3. Block Diagram

Figure 2. Block Diagram

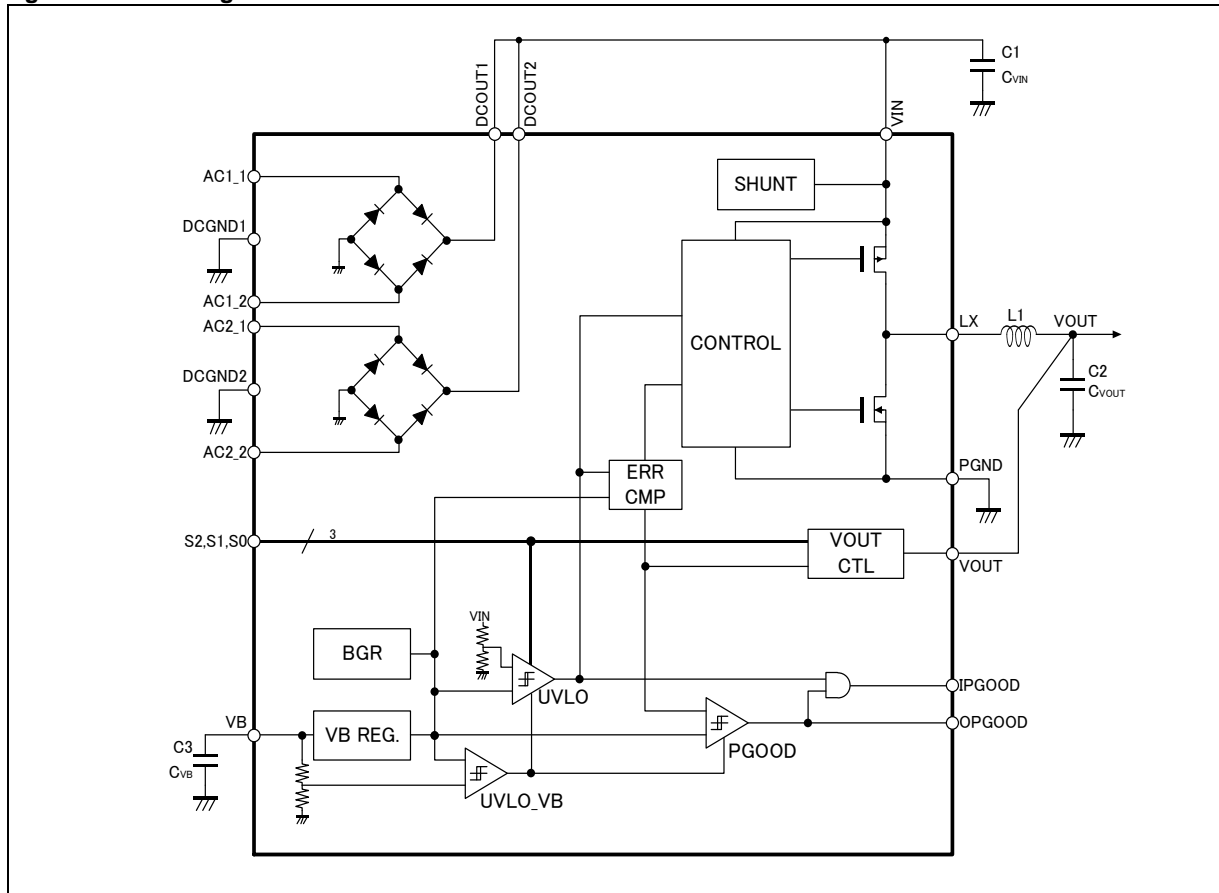

4. Absolute Maximum Ratings

Table 2. Absolute Maximum Ratings

Parameter	Symbol	Condition	Rating		Unit
			Min	Max	
VIN pin input voltage	VVINMAX	VIN pin	-0.3	+24	V
VIN pin input slew rate	SRMAX	VIN pin (VIN≥7V)	-	0.25	V/ms
VIN pin input current	IINMAX	VIN pin	-	100	mA
AC pin input voltage	VACMAX	AC1_1 pin, AC1_2 pin, AC2_1 pin, AC2_2 pin	-0.3	+24	V
AC pin input current	IPVMAX	AC1_1 pin, AC1_2 pin, AC2_1 pin, AC2_2 pin	-	50	mA
LX pin input voltage	VLXMAX	LX pin	-0.3	+24	V
Input voltage	VVINPUTMAX	S0 pin, S1 pin, S2 pin	-0.3	VVB + 0.3 (≤+7.0)	V
		VOOUT pin	-0.3	+7.0	V
Power dissipation	PD	Ta ≤ +25°C	-	2500	mW
Storage temperature	TSTG	-	-55	+125	°C
ESD voltage 1	VESDH	Human Body Model (100pF, 5kΩ)	-900	+2000	V
ESD voltage 2	VESDM	Machine Model (200pF, 0Ω)	-150	+150	V
ESD voltage3	VCDM	Charged Device Model	-1000	+1000	V

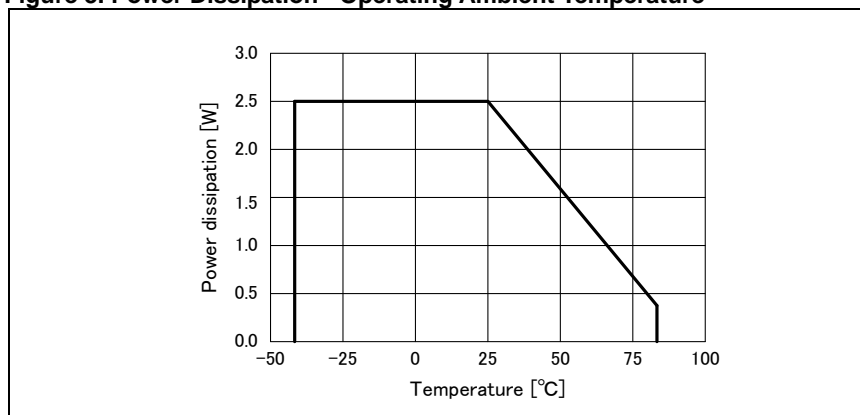
Figure 3. Power Dissipation - Operating Ambient Temperature

WARNING:

- Semiconductor devices may be permanently damaged by application of stress (including, without limitation, voltage, current or temperature) in excess of absolute maximum ratings. Do not exceed any of these ratings.

5. Recommended Operating Conditions

Table 3. Recommended operating conditions

Parameter	Symbol	Condition	Value			Unit
			Min	Typ	Max	
VIN pin input voltage	VVIN	VIN pin	2.6	-	23	V
AC pin input voltage	VPV	AC1_1 pin, AC1_2 pin, AC2_1 pin, AC2_2 pin	-	-	23	V
Input voltage	VSI	S0 pin, S1 pin, S2 pin	0	-	VVB	V
	VFB	VOUT pin	0	-	5.5	V
Operating ambient temperature	Ta	-	-40	-	+85	°C

WARNING:

- *The recommended operating conditions are required in order to ensure the normal operation of the semiconductor device. All of the device's electrical characteristics are warranted when the device is operated under these conditions.*
- *Any use of semiconductor devices will be under their recommended operating condition.*
- *Operation under any conditions other than these conditions may adversely affect reliability of device and could result in device failure.*
- *No warranty is made with respect to any use, operating conditions or combinations not represented on this data sheet. If you are considering application under any conditions other than listed herein, please contact sales representatives beforehand.*

6. Electrical Characteristics

6.1 DC Characteristics

Table 4. DC Characteristics

(Ta = -40°C to +85°C, VVIN = 7.0V, L1 = 22μH, C2 = 47μF)

Parameter	Symbol	Condition	Value			Unit
			Min	Typ	Max	
Quiescent current	IVIN	VVIN = 2.5V (UVLO), Ta = +25°C	-	550	775	nA
		VVIN = 4.5V (sleep mode), Ta = +25°C	-	1.5	2.25	μA
		VVIN = 18V (sleep mode), Ta = +25°C	-	1.9	2.85	μA
Preset output voltage	VVOUT	S2 = L, S1 = L, S0 = L, IOOUT = 1mA	1.457	1.5	1.544	V
		S2 = L, S1 = L, S0 = H, IOOUT = 1mA	1.748	1.8	1.852	V
		S2 = L, S1 = H, S0 = L, IOOUT = 1mA	2.428	2.5	2.573	V
		S2 = L, S1 = H, S0 = H, IOOUT = 1mA	3.214	3.3	3.386	V
		S2 = H, S1 = L, S0 = L, IOOUT = 1mA	3.506	3.6	3.694	V
		S2 = H, S1 = L, S0 = H, IOOUT = 1mA	3.993	4.1	4.207	V
		S2 = H, S1 = H, S0 = L, IOOUT = 1mA	4.383	4.5	4.617	V
		S2 = H, S1 = H, S0 = H, IOOUT = 1mA	4.870	5.0	5.130	V
Peak switching current	IPEAK	-	200	250	400	mA
Maximum Output current	IOUTMAX	Ta = +25°C	100*	-	-	mA
UVLO release voltage (Input power-good detection voltage)	VUVLOH	S2 = L, S1 = L, S0 = L	3.8	4.0	4.2	V
		S2 = L, S1 = L, S0 = H				
		S2 = L, S1 = H, S0 = L				
		S2 = L, S1 = H, S0 = H	4.94	5.2	5.46	V
		S2 = H, S1 = L, S0 = L				
		S2 = H, S1 = L, S0 = H				
		S2 = H, S1 = H, S0 = L				
S2 = H, S1 = H, S0 = H	6.84	7.2	7.56	V		
UVLO detection voltage (Input power-good reset voltage)	VUVLOL	S2 = L, S1 = L, S0 = L	2.6	2.8	3.0	V
		S2 = L, S1 = L, S0 = H				
		S2 = L, S1 = H, S0 = L				
		S2 = L, S1 = H, S0 = H	3.8	4.0	4.2	V
		S2 = H, S1 = L, S0 = L				
		S2 = H, S1 = L, S0 = H				
		S2 = H, S1 = H, S0 = L				
S2 = H, S1 = H, S0 = H	5.7	6.0	6.3	V		
VIN pin shunt voltage	VSHUNT	IVIN = 1mA	19	21	23	V
VIN pin shunt current	ISHUNT	-	100	-	-	mA
Output power-good detection voltage (Rising)	VOPGH	To preset voltage ratio VVOUT ≥ 3.3V ^[2]	90	94	98	%
Output power-good reset voltage (Falling)	VOPGL	To preset voltage ratio	65.5	70	74.5	%
Power supply output voltage for internal circuit	VVB	VVIN = 6V to 20V	-	5.0 ^[1]	-	V

[1]: This parameter is not be specified. This should be used as a reference to support designing the circuits.

[2]: Please contact the department in charge if use this output power-good function under the conditions of $V_{OUT} \leq 2.5V$.

6.2 Characteristics of Built-in Bridge Rectification Circuit

Table 5. Characteristics of Built-in Bridge Rectification Circuit

($T_a = +25^\circ C$)

Parameter	Symbol	Condition	Value			Unit
			Min	Typ	Max	
Forward bias voltage	VF	$I_F = 10\mu A$	150	280	450	mV
Forward direction current	IF	-	-	-	50	mA
Reverse bias leak current	IR	$V_R = 18V$	-	-	20	nA
Break down voltage	VBREAK	$I_R = 1\mu A$	VSHUNT	25	-	V

6.3 AC Characteristics (Input/Output Power-Good)

Table 6. AC Characteristics

($T_a = +25^\circ C$, $V_{OUT} = 3.3V$)

Parameter	Symbol	Condition	Value			Unit
			Min	Typ	Max	
Input power-good detection delay time (Rising)	tIPGH	$SR_{VIN} = 0.1V/ms$	-	1	-	ms
Input power-good reset delay time (Falling)	tIPGL	$SR_{VIN} = 0.1V/ms$	-	1	-	ms
Input power-good undefined time	tIPGX	OPGOOD rising	-	1	3	ms
Output power-good detection delay time (Rising)	tOPGH	$I_{OUT} = 0mA$, $L1 = 22\mu H$, $C2 = 47\mu F$	-	1	-	ms
Output power-good reset delay time (Falling)	tOPGL	$I_{OUT} = 1mA$, $C2 = 47\mu F$	-	1	-	ms

Figure 4. AC characteristics

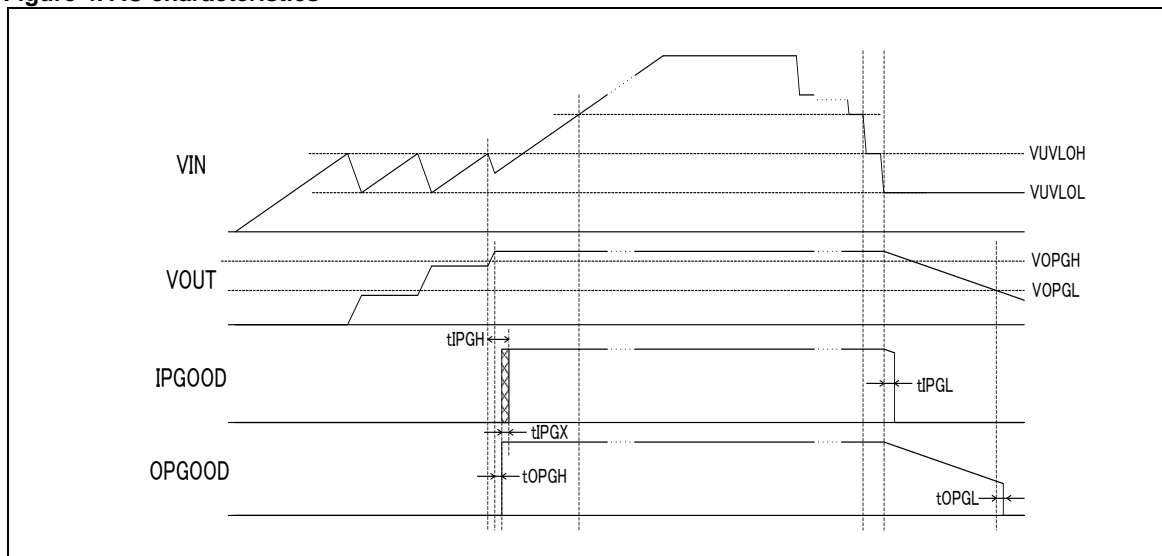

7. Function

7.1 Operational Summary

Bridge Rectifier

The A/C voltage which is input to the AC1_1 and AC1_2 pins or the AC2_1 and AC2_2 pins is all-wave rectified at the bridge rectifier of the low-dissipation diode. The bridge rectifier output is output from the DCOUT1 pin and the DCOUT2 pin. By connecting those outputs to the VIN pin, the electric charge is accumulated to the capacitor and it is used as the energy condenser of the buck converter.

Power Supply for Internal Circuit

When the VIN pin voltage is 3.5V or lower, the power supply is supplied from the VIN pin to the internal circuit directly. If the VIN pin is over 3.5V, the internal regulator is activated and the power supply is supplied from the internal regulator to the internal circuit. Therefore, the stable output voltage is maintained in the wide input voltage range 2.6 V to 23V.

DC/DC Start-Up/Shut-Down

When the VIN pin voltage is over the release voltage VUVLOH for the under voltage lockout protection circuit (UVLO), the converter circuit is enabled and the electric charge is supplied from the input capacitor to the output capacitor. When the VIN pin voltage is below the UVLO detection voltage VUVLOL, the converter is disabled. The 12V hysteresis between the release voltage and the detection voltage for UVLO prevents the converter from noise or frequent ON/OFF which is caused by the VIN pin voltage-drop during start-up.

Sleep/Auto Active Control

When the feedback voltage VFB for the converter reaches the determinate voltage, the sleep state to stop the switching operation starts and that can reduce the consumption power from the internal circuit. When the VOUT voltage is below the threshold value, the VOUT voltage is maintained to the rated value by making the converter active again.

7.2 Start-Up/Shut-Down Sequences

Figure 5. Timing Chart

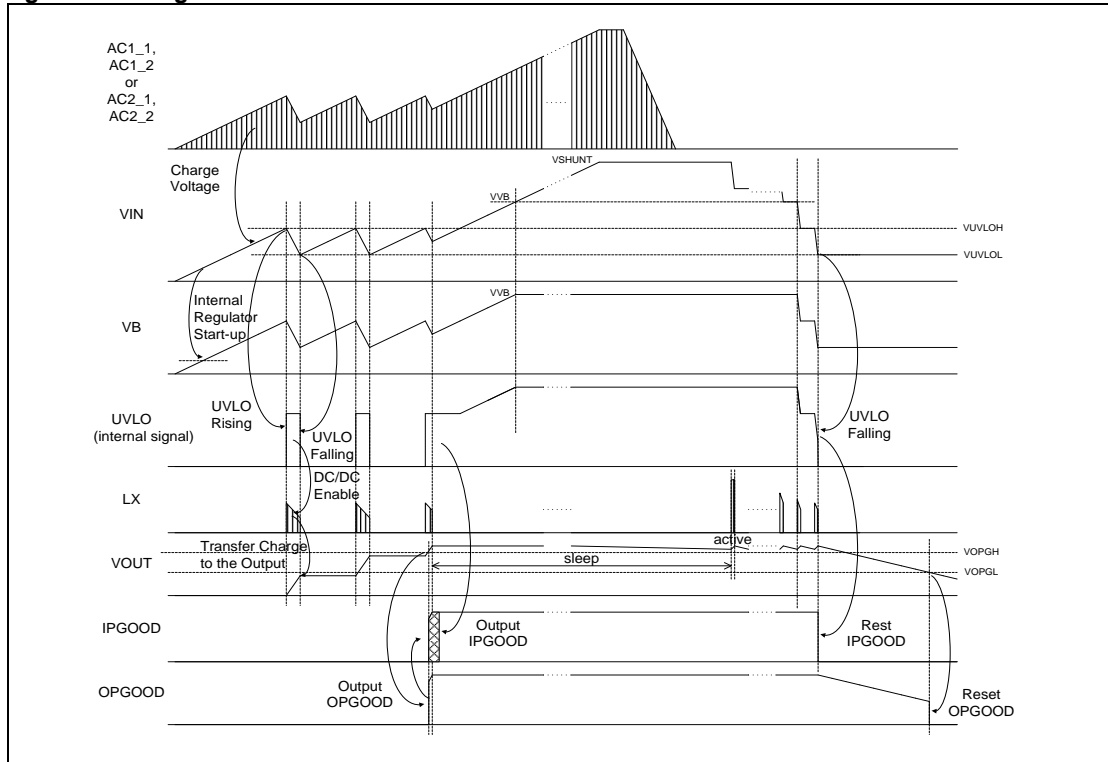

7.3 Function Descriptions

Output Voltage Setting and Under Voltage Lockout Protection (UVLO) Function

It is possible to select the output voltage from eight kinds of presets using the S2, S1 and S0 pins.

Also, the under voltage lockout protection circuit is provided to prevent IC's malfunction by the transient state or the instant drop during the VIN pin voltage activation, system destroy and deterioration, and it is set as follows according to the preset voltage. When the VIN pin exceeds the release voltage for the UVLO circuit, the system is recovered.

Table 7. Output Voltage Setting and Under Voltage Lockout Protection (UVLO) Function

S2	S1	S0	VOUT[V]	Under voltage lockout protection (UVLO) -Typ-	
				Detection voltage (Falling) VUVLOL [V]	Release voltage (Rising) VUVLOH [V]
L	L	L	1.5	2.8	4.0
L	L	H	1.8		
L	H	L	2.5		
L	H	H	3.3	4.0	5.2
H	L	L	3.6		
H	L	H	4.1	6.0	7.2
H	H	L	4.5		
H	H	H	5.0		

Input/output power-good signal output

When the VIN pin input voltage is equal to the release voltage VUVLOH for UVLO or more, the output for the IPGOOD pin is set to the “H” level as the input power-good. When the VIN pin input voltage is equal to the detection voltage VUVLOL for UVLO or less, the output for the IPGOOD pin is reset to the “L” level. The IPGOOD output is enabled only when the following output power-good signal output OPGOOD is “H” level.

The output power-good signal OPGOOD is set to the “H” level when the feedback voltage VFB for the VOUT pin is equal to the detection voltage VOPGH or more. When the feedback voltage VFB is equal to the reset voltage VOPGL or less, the output for the OPGOOD pin is reset to the “L” level.

Table 8. Input Power-Good Signal Output (IPGOOD)

OPGOOD	UVLO	IPGOOD
L	Don't care	L
H	L	L
H	H	H

Table 9. Output Power-Good Signal Output (OPGOOD)

VFB	OPGOOD
$\leq VOPGL$	L
$\geq VOPGH$ ($V_{VOUT} \geq 3.3V$) ^[1]	H

[1]:Please contact the department in charge if use this output power-good function under the conditions of $V_{VOUT} \leq 2.5V$.

Figure 6. Input/Output Power-Good Signal Output

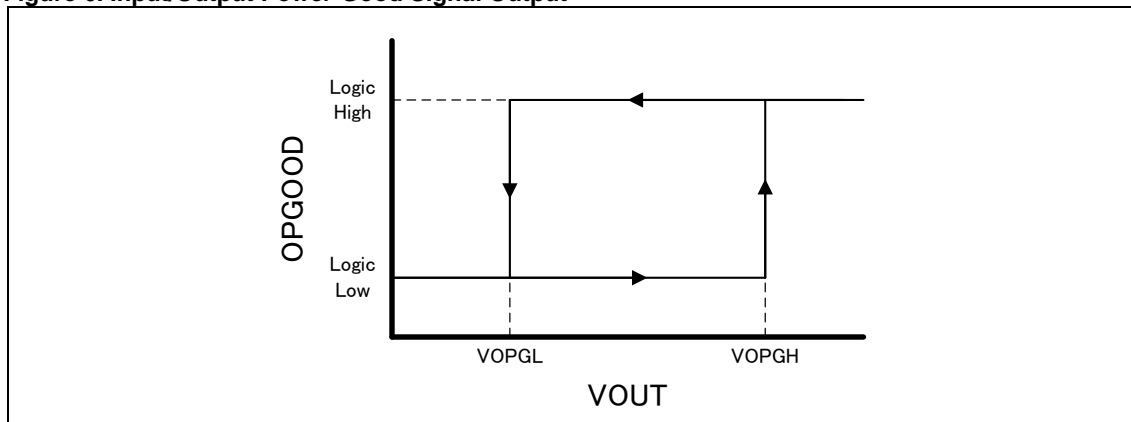

Input Over Voltage Protection

If the voltage exceeding VSHUNT (Typ : 21V) is input to the VIN pin, the input level is clamped enabling the over voltage protection circuit. The flowing current is ISHUNT (Min 100mA) during clamp.

Over Current Protection

If the output current for the LX pin reaches the over current detection level IPEAK, the circuit is protected by controlling the peak value for the inductor current setting the main side FET to the OFF state.

8. Typical Application Circuits

Figure 7. Application Circuit For Photovoltaic Energy Harvester

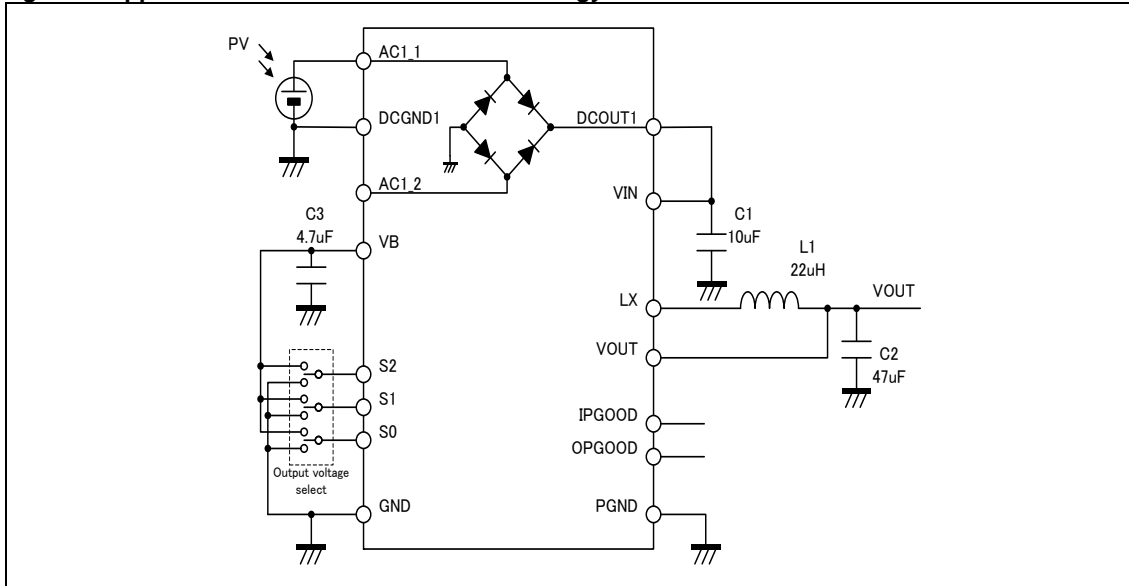

Figure 8. Application circuit for vibration energy harvester

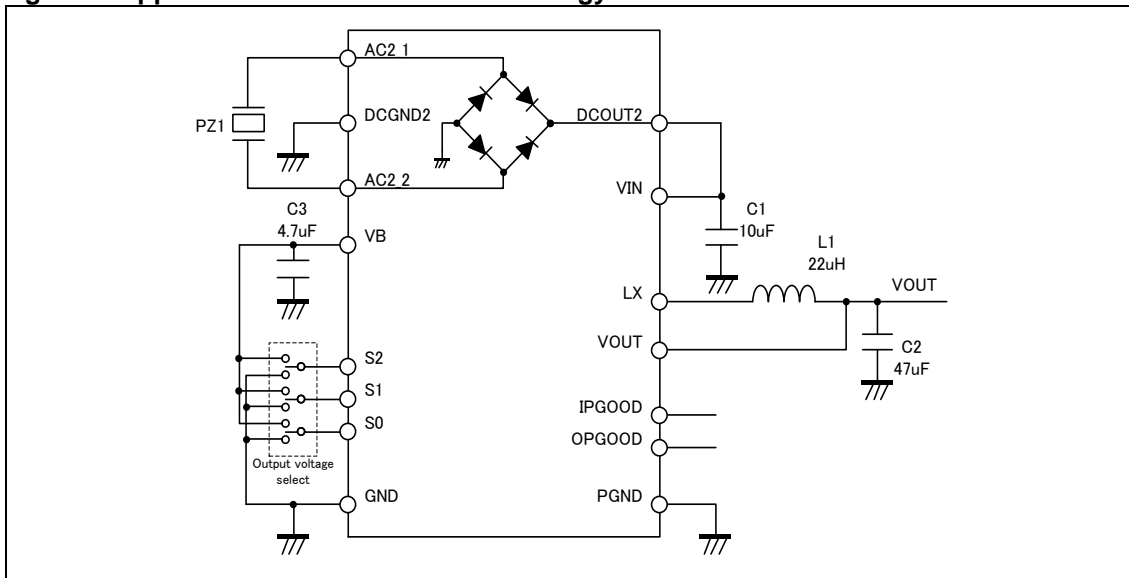
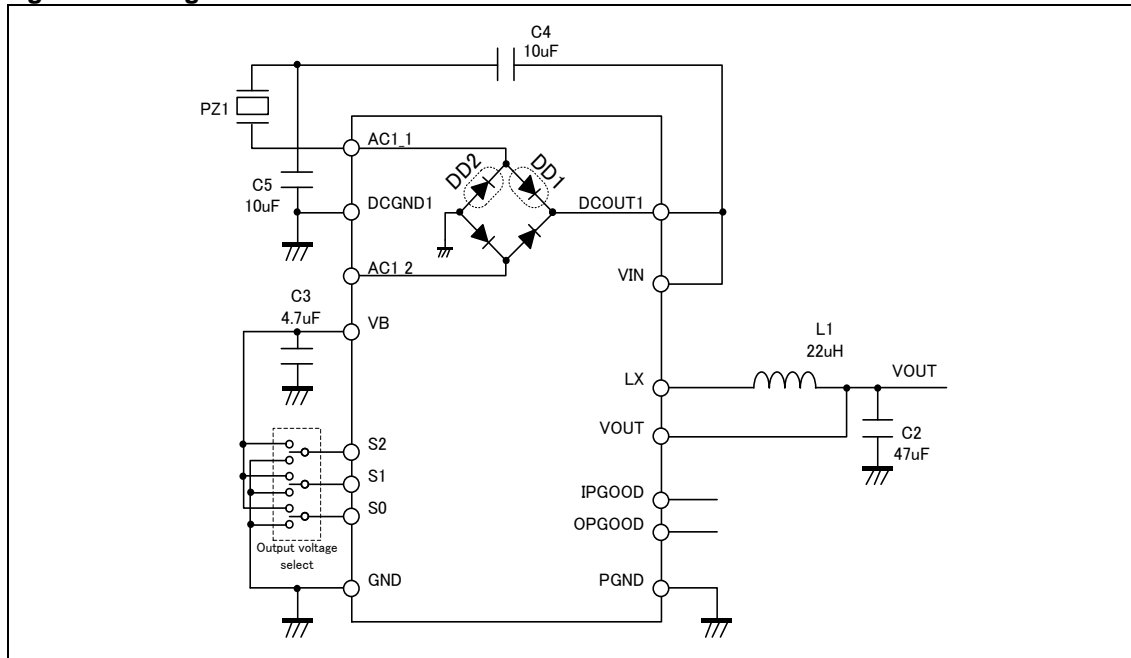

Figure 9. Voltage doubler rectification circuit for vibration harvester

Operation of the double voltage rectifier circuit rectifying an AC input voltage

When the AC1_1 input voltage is positive, the capacitor C4 charges up through the diode DD1, and when the AC1_1 input voltage is negative, the capacitor C5 charges up through the diode DD2. Each capacitor takes on a charge of the positive peak of the AC input. The output voltage at the VIN pin is the series total of C4+C5.

Table 10. Parts list

Part number	Value	Description
C1	10µF ^[1]	Capacitor
C2	47µF ^[1]	Capacitor
C3	4.7µF	Capacitor
C4	10µF ^[1]	Capacitor
C5	10µF ^[1]	Capacitor
L1	10µH to 22µH	Inductor

[1]: Adjust the values according to the source supply ability and the load power.

9. Application Notes

Inductor

The MB39C811 is optimized to work with an inductor in the range of 10 μ H to 22 μ H. Also, since the peak switching current is up to 400mA, select an inductor with a DC current rating greater than 400mA.

Table 11. Manufactures of Recommended Inductors

Part number	Value	Manufacture
LPS5030-223ML	22 μ H	Coilcraft, Inc.
VLF403215MT-220M	22 μ H	TDK Corporation

Harvester (Photovoltaic Power Generator)

In case of photovoltaic energy harvesting, such as solar or light energy harvesting, use a solar cell with high open-circuit voltage which must be higher than the UVLO release voltage. Electric power obtained from light or solar is increased in proportion to the ambient illuminance.

There are silicone-based solar cells and organic-based solar cells about photovoltaic power generators. Silicone-based solar cells are single crystal silicon solar cell, polycrystalline silicon solar cell, and amorphous silicon solar cell. Organic-based solar cells are dye-sensitized solar cell (DSC), and organic thin film solar cell. Crystal silicon and polycrystalline silicon solar cells have high energy conversion efficiency. Amorphous silicon solar cells are lightweight, flexible, and produced at low cost. Dye-sensitized solar cells are composed by sensitizing dye and electrolytes, and are low-cost solar cell. Organic thin film solar cells are lightweight, flexible, and easily manufactured.

Table 12. Manufactures Of Photovoltaic Harvesters

Part number/Series name	Type	Manufacture
BCS4630B9	Film amorphous silicon solar cells	TDK Corporation
Amorton	Amorphous silicon solar cells	Panasonic Corporation

Harvester (Vibration Power Generator, Piezoelectric Generator)

Vibration power generators produce AC power by vibration. For AC to DC rectification, the MB39C811 integrates two bridge rectifiers. Electric power obtained from a vibration power generator depends on frequency of vibration and usage of the generator. Although, vibration generators produce high voltage, the shunt circuit protects from higher voltage than 21V.

There are electromagnetic induction generators and piezoelectric generators about vibration harvesters. The electromagnetic induction generator is consists of coil and magnet. The piezoelectric generators are made from plastics or ceramics. Plastic-based piezoelectric generators made from polyvinylidene fluoride are lightweight, flexible. Ceramic-based piezoelectric generators are made from barium titanate or lead zirconate titanate ceramics.

Table 13. Manufactures of Vibration Harvesters

Part number	Type	Manufacture
EH12, EH13, EH15	Electromagnetic induction	Star Micronics Co., Ltd.

Sizing of Input and Output Capacitors

Energy from harvester should be stored on the Cin and Cout to operate the application block. If the size of these capacitors were too big, it would take too much time to charge energy into these capacitors, and the system cannot be operated frequently. On the other hand, if these capacitors were too small, enough energy cannot be stored on these capacitors for the application block. The sizing of the Cin and Cout is important.

Common capacitors are layered ceramic capacitor, electrolytic capacitor, electric double layered capacitor, and so on. Electrostatic capacitance of layered ceramic capacitors is relatively small. However, layered ceramic capacitors are small and have high voltage resistance characteristic. Electrolytic capacitors have high electrostatic capacitance from μF order to mF order. The size of capacitor becomes large in proportion to the size of capacitance. Electric double layered capacitors have high electrostatic capacitance around 0.5F to 1F, but have low voltage resistance characteristics around 3V to 5V. Be very careful with a voltage resistance characteristic. Also, leak current, equivalent series resistance (ESR), and temperature characteristic are criteria for selecting,

Table 14. Manufactures Of Capacitors

Part number/Series name	Type, Capacitance	Manufacture
EDLC351420-501-2F-50	EDLC, 500mF	TDK Corporation
EDLC082520-500-1F-81	EDLC, 50mF	
EDLC041720-050-2F-52	EDLC, 5mF	
Gold capacitor	EDLC	Panasonic Corporation

First of all, apply the following equation and calculate energy consumption for an application from voltage, current, and time during an operation.

$$E_{\text{Appli.}}[J] = V_{\text{Appli.}} \times I_{\text{Appli.}} \times t_{\text{Appli.}}$$

The energy stored on a capacitor is calculated by the following equation.

$$E_c[J] = \frac{1}{2} CV^2$$

Since the energy in a capacitor is proportional to the square of the voltage, it is energetically advantageous for the buck DC/DC converter to make the Cin larger.

An example of an application using the power gating by the OPGOOD signal is shown in the [Figure 10](#). The Cin and the Cout are sized so as to satisfy the following equation. The η , the efficiency of the MB39C811, is determined from the current of application and the graph shown in [Figure 12](#), Efficiency vs IOUT.

$$E_{\text{Appli.}} \leq dE_{\text{Cin}} \times \eta + dE_{\text{Cout}}$$

dE_{Cin} and dE_{Cout} are the available energies for the application.

$$dE_{\text{Cin}}[J] = \frac{1}{2} C_{\text{in}}(V_{\text{UVLOH}}^2 - V_{\text{UVLOL}}^2)$$

$$dE_{\text{Cout}}[J] = \frac{1}{2} C_{\text{out}}(V_{\text{VOUT}}^2 - V_{\text{VOPGL}}^2)$$

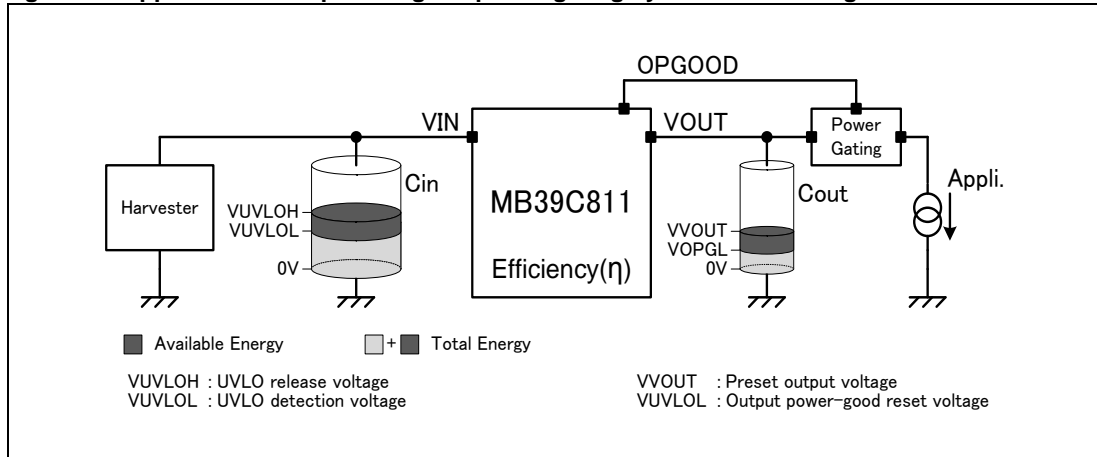
Figure 10. Application example using the power gating by the OPGOOD signal

Before calculating the initial charging time ($T_{Initial}[s]$), calculate the total energy (E_{Cin} and E_{Cout}) stored on both C_{in} and C_{out} .

$$E_{Cout}[J] = \frac{1}{2} C_{in} \times VUVLOH^2$$

$$E_{Cout}[J] = \frac{1}{2} C_{out} \times VVOUT^2$$

A $P_{Harvester}[W]$ is a power generation capability of a harvester. An initial charging time ($T_{Initial}[s]$) is calculated by the following equation.

$$T_{Initial} = \frac{E_{Cin}}{P_{Harvester}} + \frac{E_{Cout}}{P_{Harvester} \times \eta}$$

A repeat charging time ($T_{Repeat}[s]$) is calculated by the following equation. The $T_{Repeat}[s]$ become shorter than the $T_{Initial}[s]$.

$$T_{Repeat} = \frac{dE_{Cin}}{P_{Harvester}} + \frac{dE_{Cout}}{P_{Harvester} \times \eta}$$

Additionally, waiting for a period of time after the OPGOOD signal goes high can store more energy on the capacitor C_{in} Figure 11.

$$dE_{Cout}[J] = \frac{1}{2} C_{in}(V_{OpenCircuitVoltage}^2 - VUVLOL^2)$$

Figure 11. Waiting for a Period of Time after the OPGOOD Signal goes High

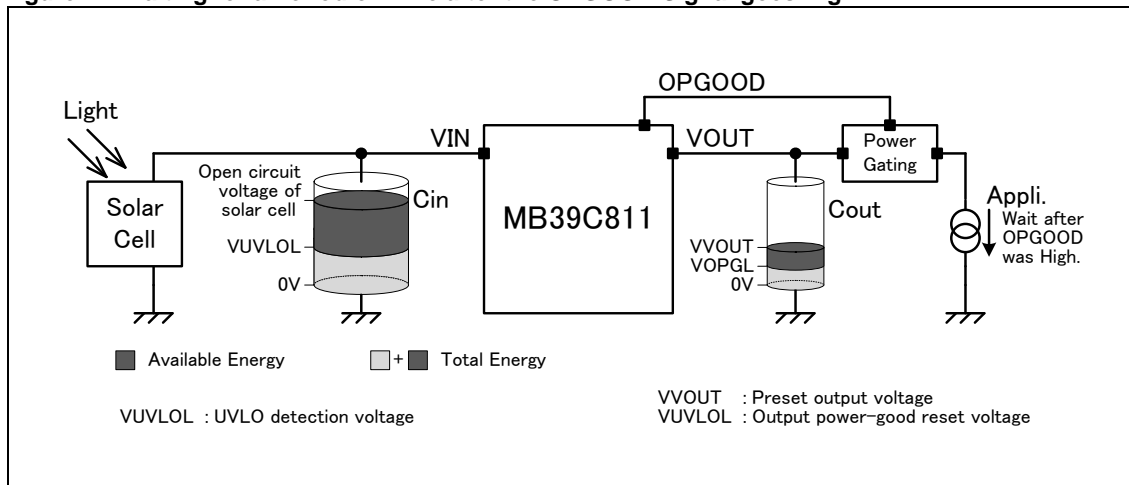

For more information about the energy calculation, refer to the APPLICATION NOTE, Energy Calculation For Energy Harvesting.

10. Typical Characteristics

Figure 12. Typical characteristics of DC/DC Converter

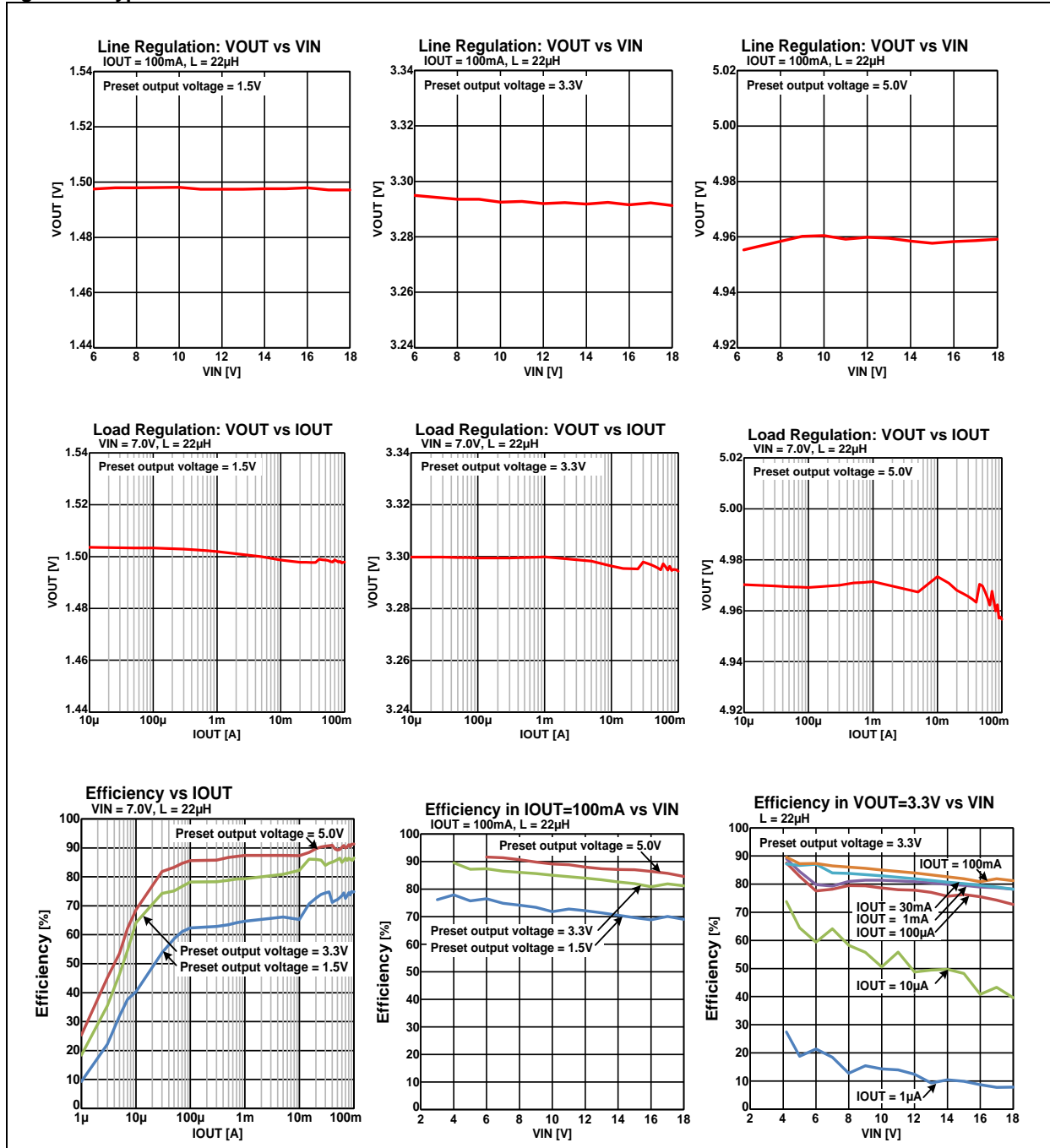

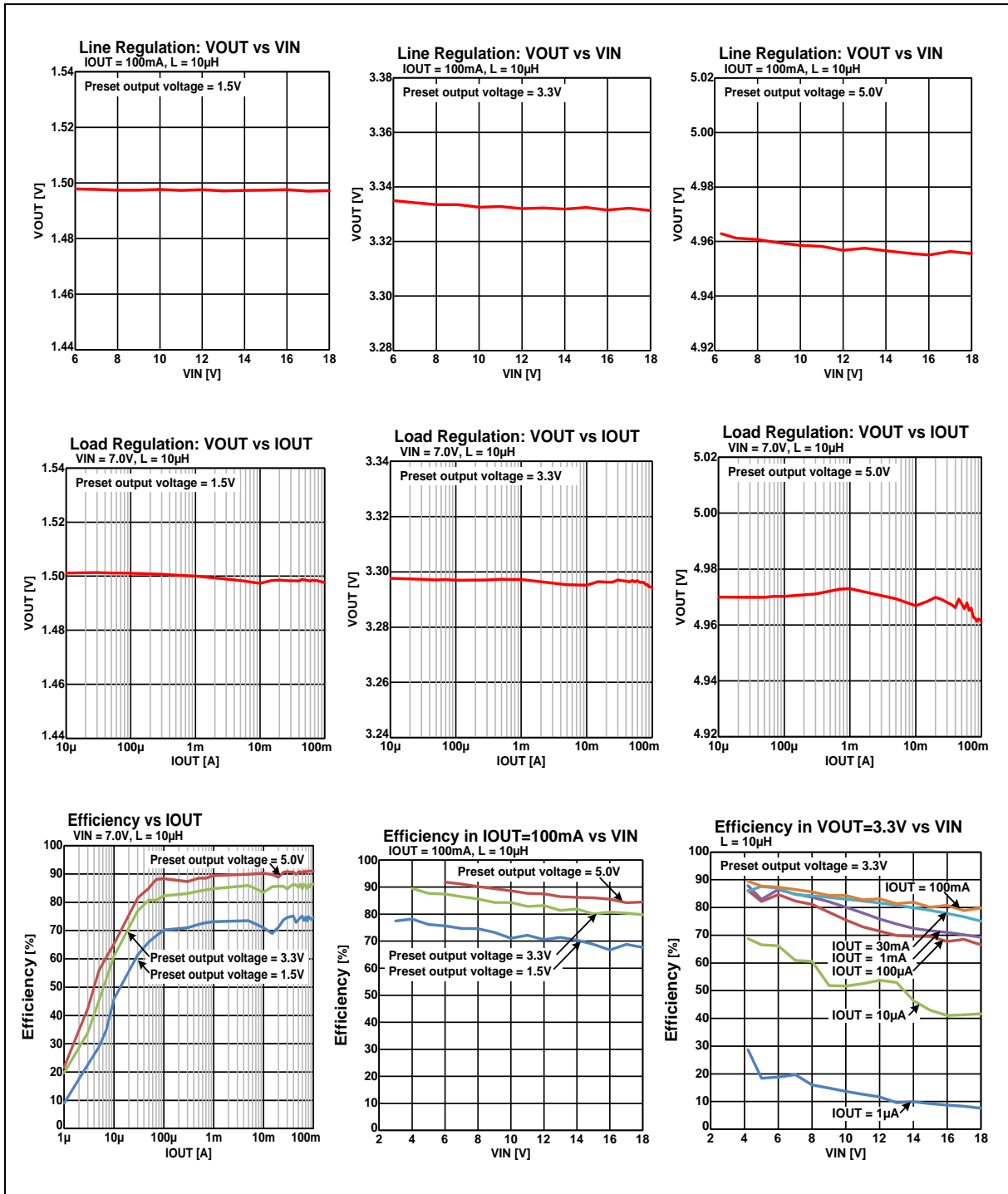

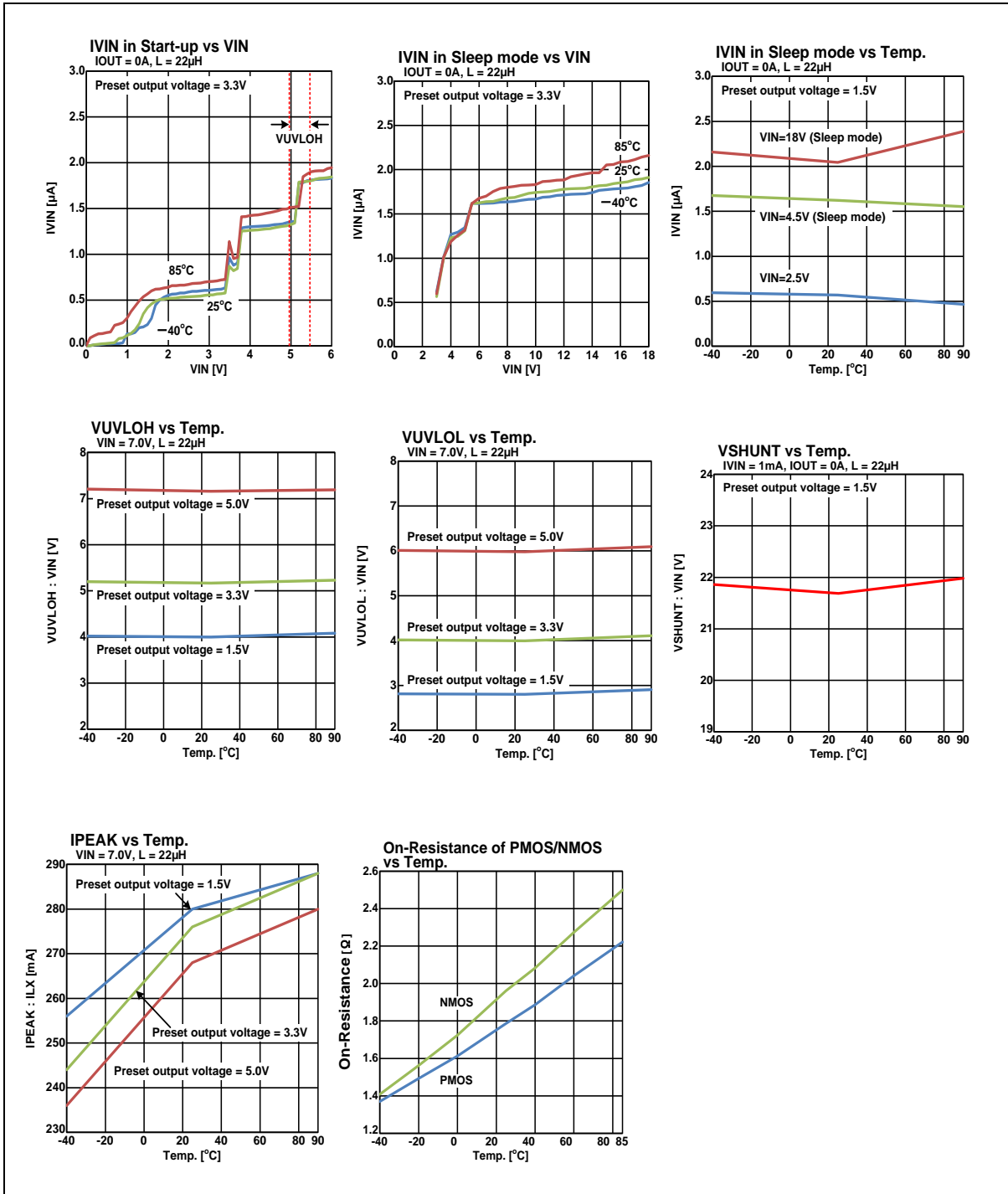

Figure 13. Typical Characteristics of Bridge Rectifier

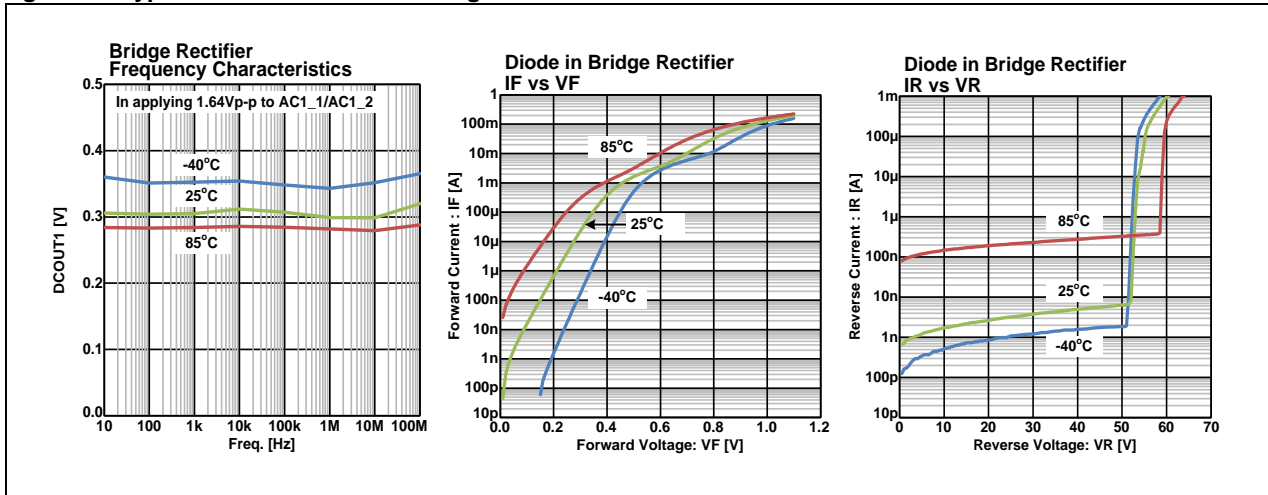

Figure 14. DC/DC Converter Sudden Load Change

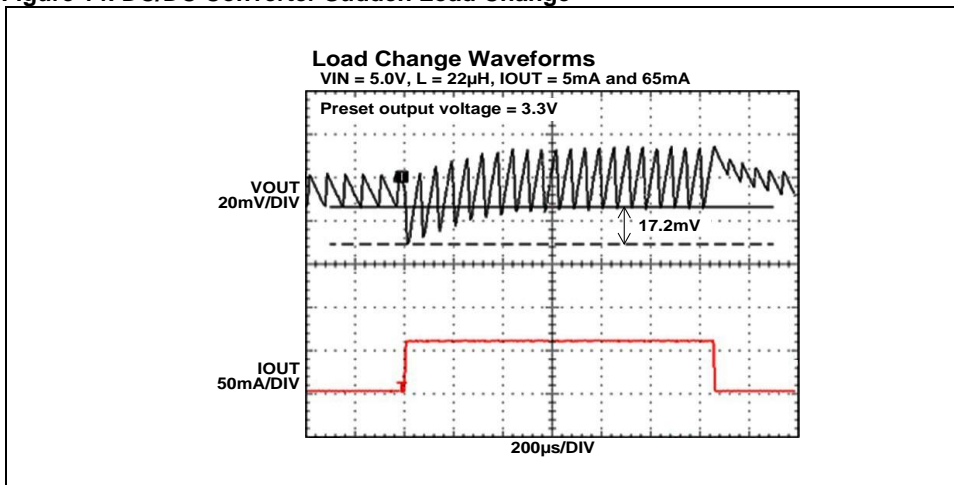
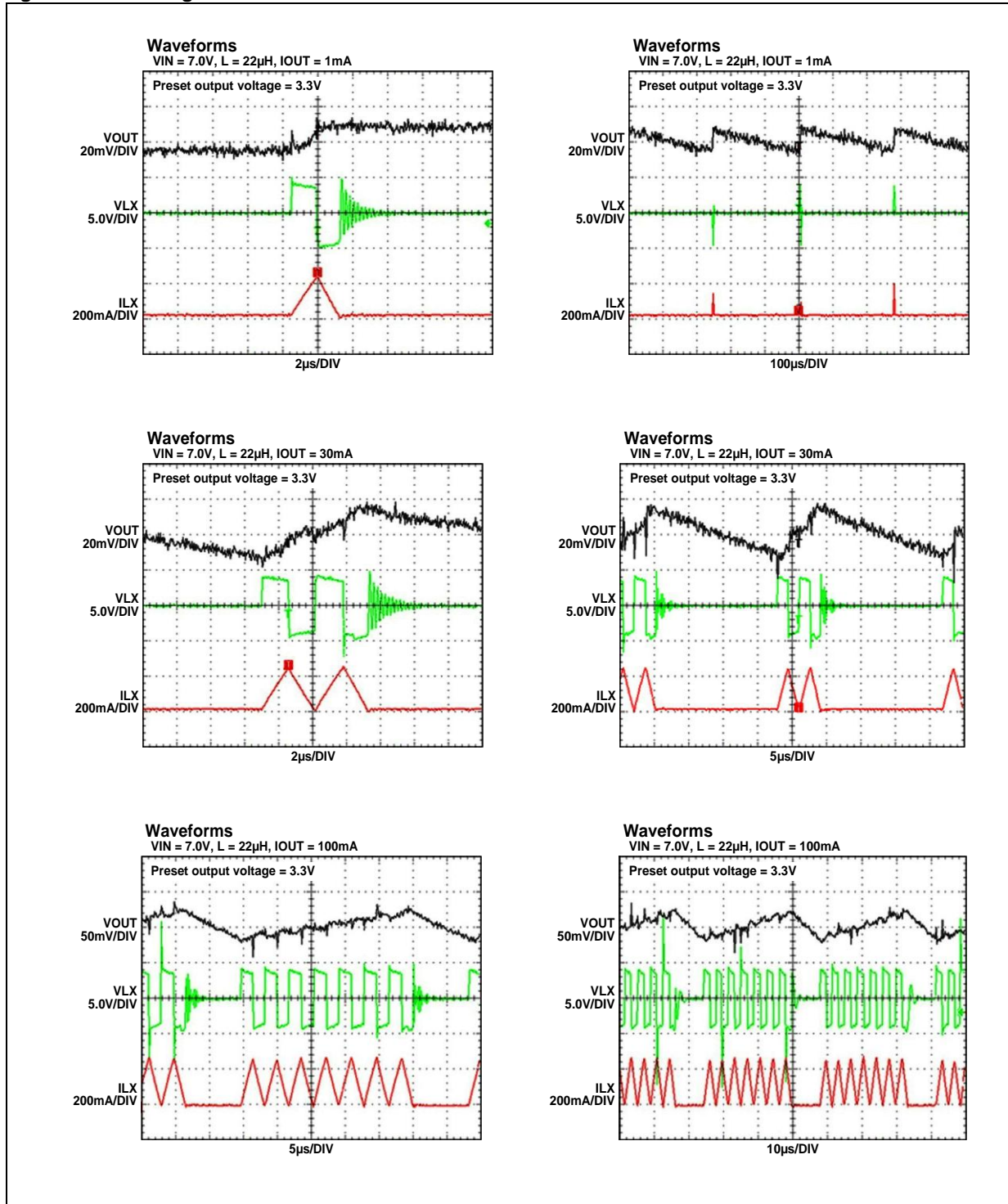
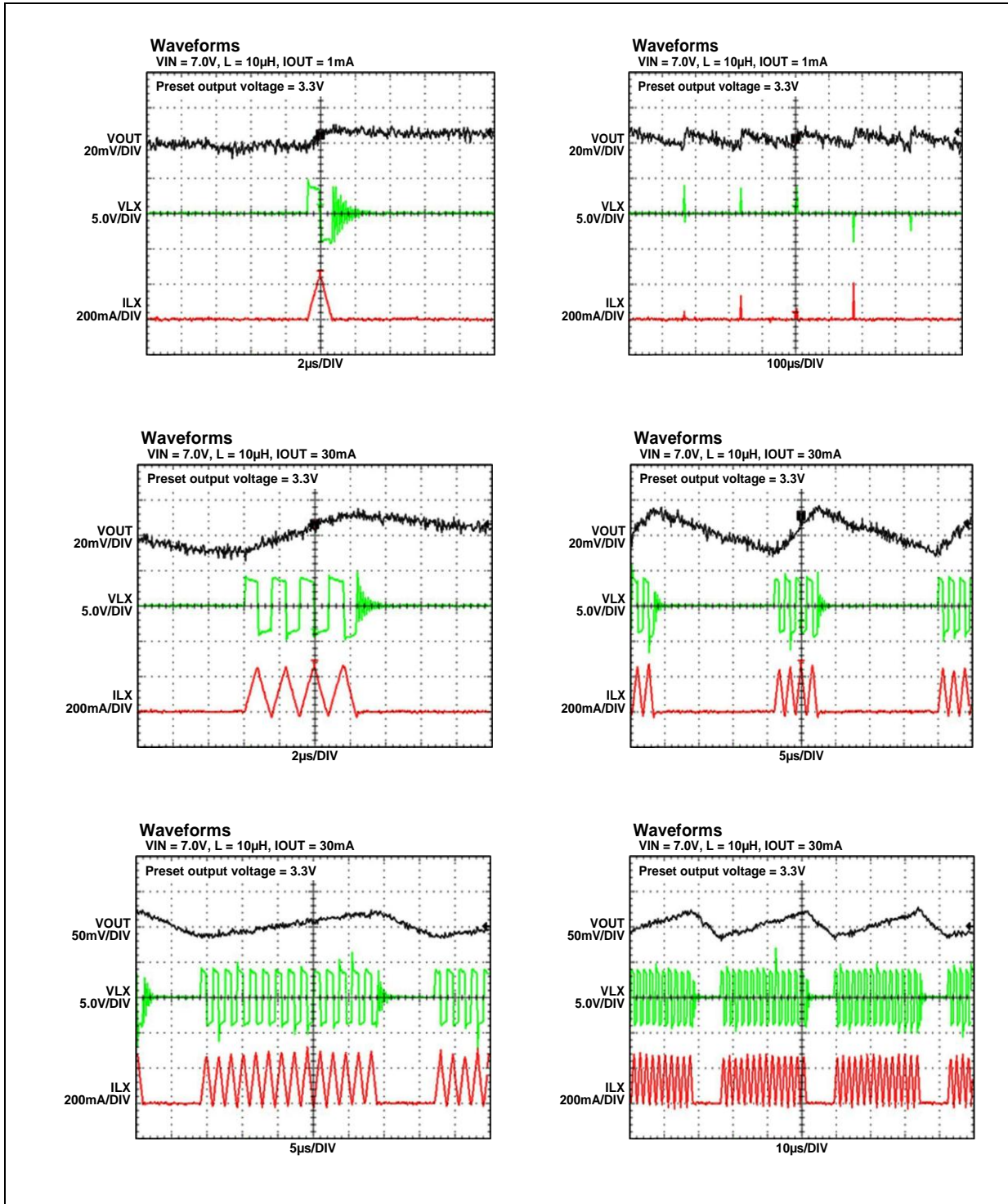

Figure 15. Switching Waveforms of DC/DC Converter





11. Layout for Printed Circuit Board

Note the points listed below in layout design

- Place the switching parts^[1] on top layer, and avoid connecting each other through through-holes.
- Make the through-holes connecting the ground plane close to the GND pins of the switching parts^[1]
- Be very careful about the current loop consisting of the input capacitor CVIN, the VIN pin of IC, and the PGND pin. Place and connect these parts as close as possible to make the current loop small.
- The output capacitor CVOUT and the inductor L are placed adjacent to each other.
- Place the bypass capacitor CVB close to VB pin, and make the through-holes connecting the ground plane close to the GND pin of the bypass capacitor CVB.
- Draw the feedback wiring pattern from the VOUT pin to the output capacitor CVOUT pin. The wiring connected to the VOUT pin is very sensitive to noise so that the wiring should keep away from the switching parts^[1]. Especially, be very careful about the leaked magnetic flux from the inductor L, even the back side of the inductor L.

[1]: Switching parts: IC (MB39C811), Input capacitor (CVIN), Inductor (L), Output capacitor (CVOUT).

Refer to [Figure 2](#).

Figure 16. Example of a Layout Design

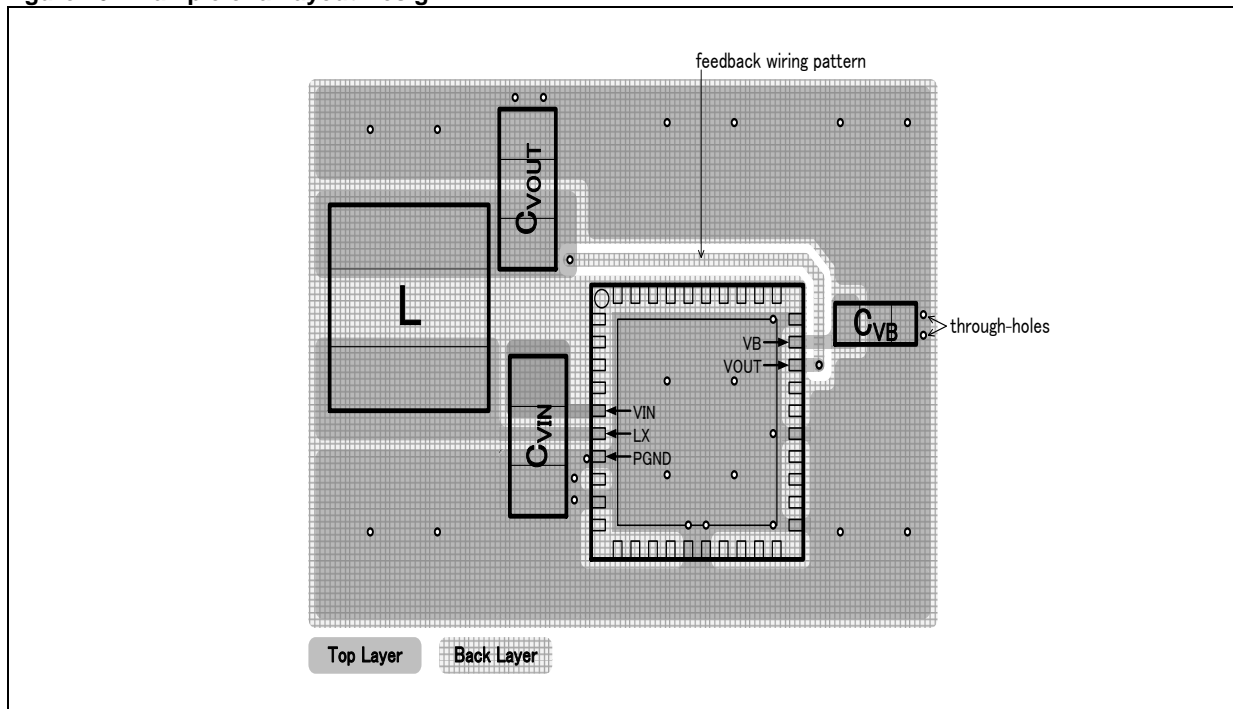

12. Usage Precaution

Do Not Configure the IC Over the Maximum Ratings

If the IC is used over the maximum ratings, the LSI may be permanently damaged.

It is preferable for the device to be normally operated within the recommended usage conditions. Usage outside of these conditions can have a bad effect on the reliability of the LSI.

Use the Devices within Recommended Operating Conditions

The recommended operating conditions are the recommended values that guarantee the normal operations of LSI. The electrical ratings are guaranteed when the device is used within the recommended operating conditions and under the conditions stated for each item.

Printed Circuit Board Ground Lines should be set up with Consideration for Common Impedance

Take Appropriate Measures against Static Electricity

- Containers for semiconductor materials should have anti-static protection or be made of conductive material.
- After mounting, printed circuit boards should be stored and shipped in conductive bags or containers.
- Work platforms, tools, and instruments should be properly grounded.
- Working personnel should be grounded with resistance of 250 kΩ to 1MΩ in series between body and ground.

Do not apply Negative Voltages

The use of negative voltages below -0.3V may cause the parasitic transistor to be activated on LSI lines, which can cause malfunctions.

13. Ordering Information

Table 15. Ordering Information

Part number	Package
MB39C811QN	40-pin plastic QFN (LCC-40P-M63)





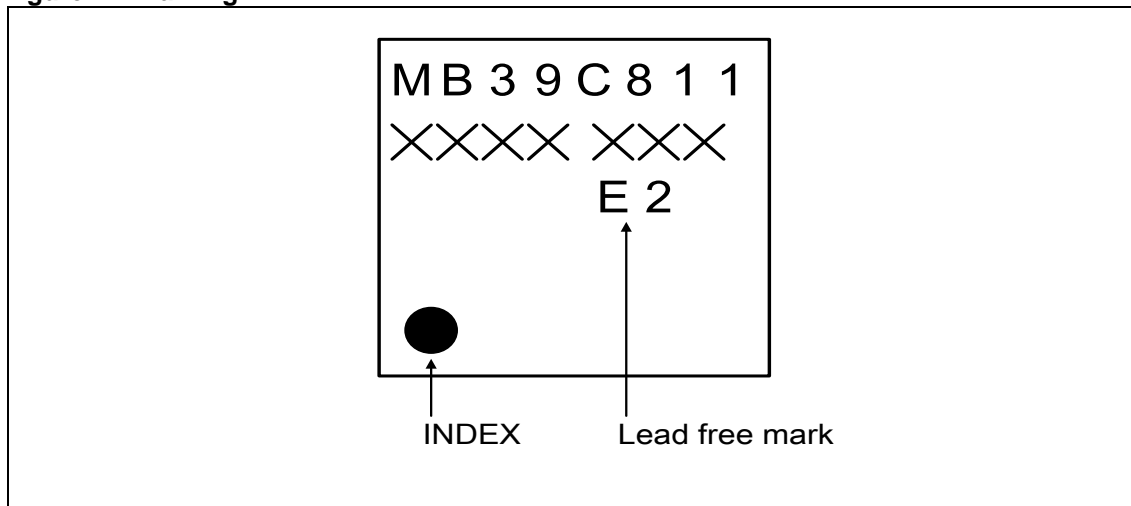















14. Marking

Figure 17. Marking



15. Product Labels

Figure 18. Inner Box Label [Q-Pack Label (4 × 8.5 inch)]

		1234	
RoHS	2Li	12345678901234567890 1234567	
Category=	12		
SPEC#	123456789012345678		
IDV	1234567890	PKG	123456 FULL CNTR QTY 1234
			
(1P) MFR#	123456789012345678901234		
(P) OPN	123456789012345678901234		
(1Z) BOX ID			
LOT#	1234567		
HU		123	BOX OF 123
HULN	1234567890123		
(1T) BATCH#	1234567000 		
			
12345678901234567890123		123456789012345	
			
SEAL DC	12345678	TTL QTY (Q)	12345 
ASSEMBLED IN:	12	1234567890123456789012345	
12345678901234567890			
12345678901234567890			
12345678901234567890			
123456789012345			
(9D)M/C: 001HH071			
(7Q)QTY: 02500PC			
12345678 12345678	12345678 1234567		
			
12345678 12345678	12345678 1234567		
			
12345678 12345678	12345678 1234567		
			
12345678 12345678	12345678 1234567		
			
12345678 12345678	12345678 1234567		
			
12345678 12345678	12345678 1234567		

Label spec : Conformable JEDEC
Barcode form : Code 39

Ordering Part Number (P)+Part No.

Quantity

Mark lot information

Figure 20. Reel label [Reel label (4 x 2.5 inch)]

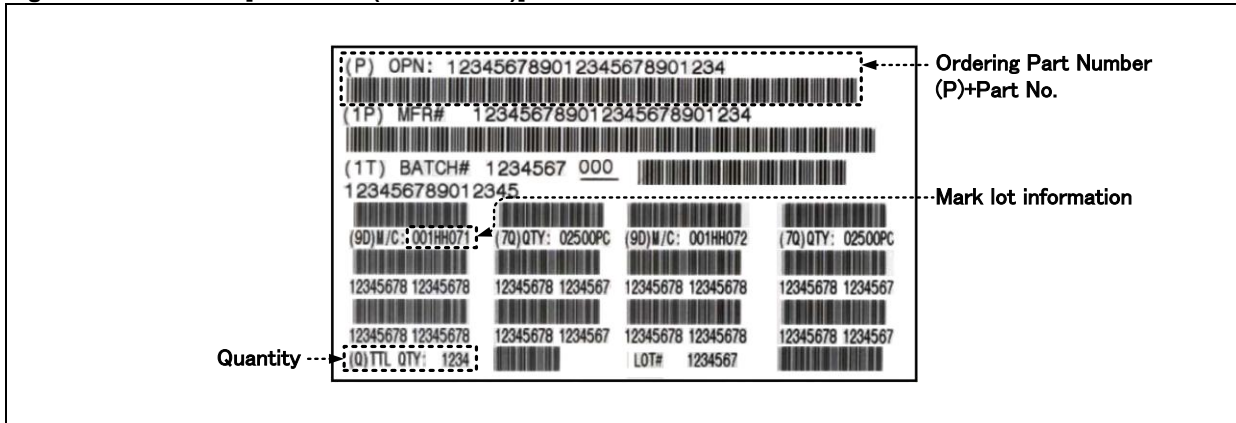

Figure 21. Reel label [Dry pack & Reel label (4 x 2.5 inch)]

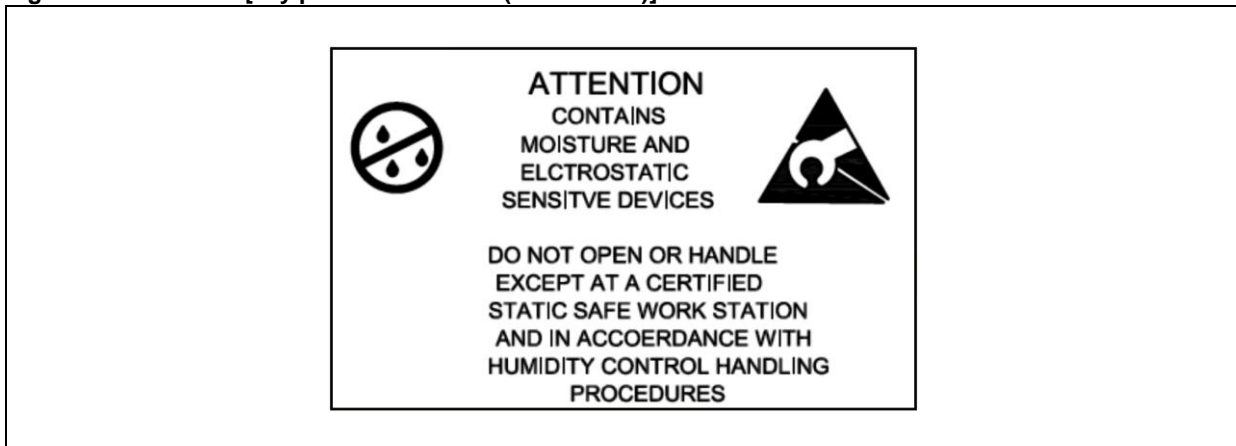









Figure 22. Outer box label [Shopping label (4 x 8.5 inch)]

Quantity		Ordering Part Number : (1P)+Part No.	
(3S) PKG ID: 80000599 		FROM: Spansion LLC and its affiliates 915 DeGuigne Drive, P.O. Box 3453 SUNNYVALE, CA 94088-3453 SHIP TO: 1234567890123456789012345678901234567890 1234567890123456789012345678901234567890 1234567890123456789012345678901234567890 1234567890123456789012345678901234567890 1234567890123456789012345678901234567890 1234567890123456789012345678901234567890 1234567890123456789012345678901234567890 1234567890123456789012345678901234567890 1234567890123456789012345678901234567890	
(1P) MFR P/N: 123456789012345678901234 			
(Q) QUANTITY:  12345678 EA		(4L) CTRY OF ORIGIN:  12 123456789012345	
(K) TRANS ID: 12345678901234567890123456789012345 		DESC: I. C. HU NO. 1234567890123 	
(P) CUST PROD ID: 123456789012345678901234 		CTRY OF DIFFUSION: 12 12 12 12 12 12 ASSEMBLED IN: 123456789012345 DEL NO. 80000599 	

16. Recommended Mounting Conditions

Table 16. Recommended Mounting Conditions

Items	Contents	
Method	IR(Infrared Reflow) / Convection	
Times	3 times in succession	
Floor life	Before unpacking	Please use within 2 years after production.
	From unpacking to reflow	Within 7 days
	In case over period of floor life ^[1]	Baking with 125°C+/-3°C for 24hrs+2hrs/-0hrs is required. Then please use within 7 days. (Please remember baking is up to 2 times)
Floor life condition	Between 5°C and 30°C and also below 70%RH required. (It is preferred lower humidity in the required temp range.)	

[1]: Concerning the Tape & Reel product, please transfer product to heatproof tray and so on when you perform baking. Also please prevent lead deforming and ESD damage during baking process.

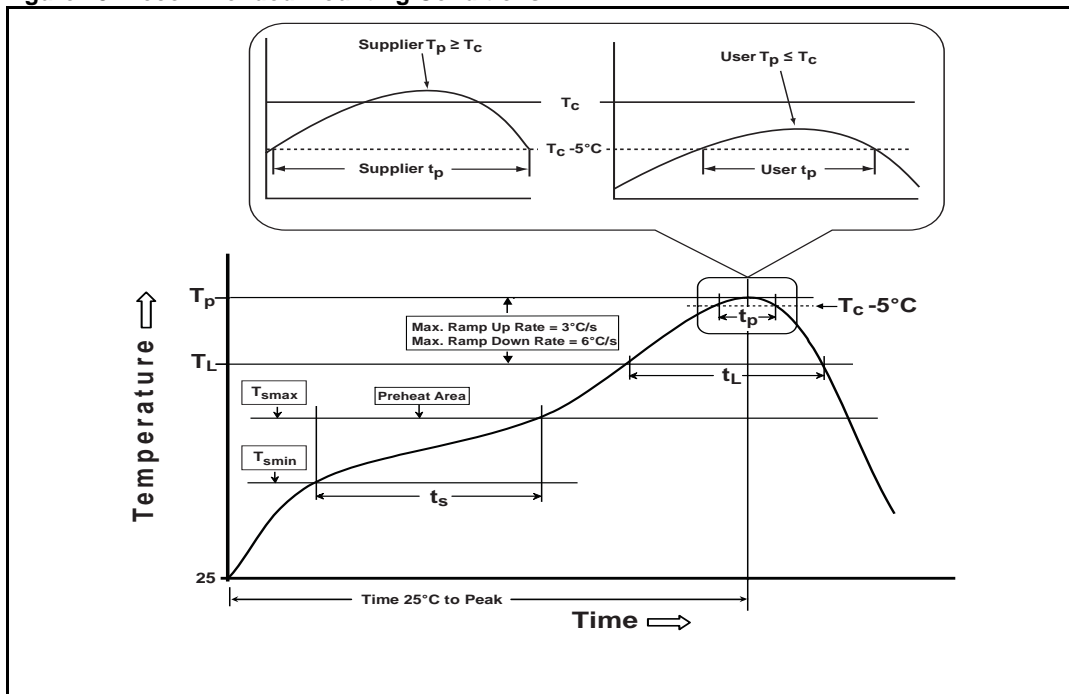
Figure 23. Recommended Mounting Conditions

Table 17. Recommended Mounting Conditions(J-STD-020D)

(Temperature on the top of the package body is measured.)

260°C Max.	
TL to TP: Ramp Up Rate	3°C/s Max.
TS: Preheat & Soak	150 to 200°C, 60 to 120s
TP - tP: Peak Temperature	260°C Down, within 30s
TL - tL: Liquidous Temperature	217°C, 60 to 150s
TP to TL: Ramp Down Rate	6°C/s Max.
Time 25°C to Peak	8min Max.

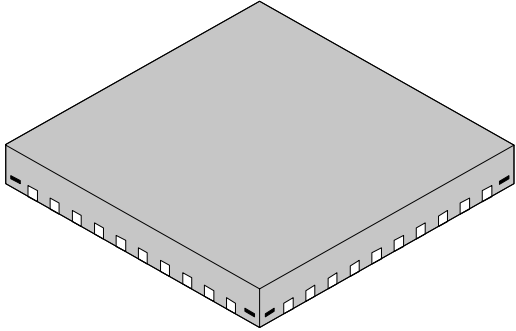
17. PackageDimensions

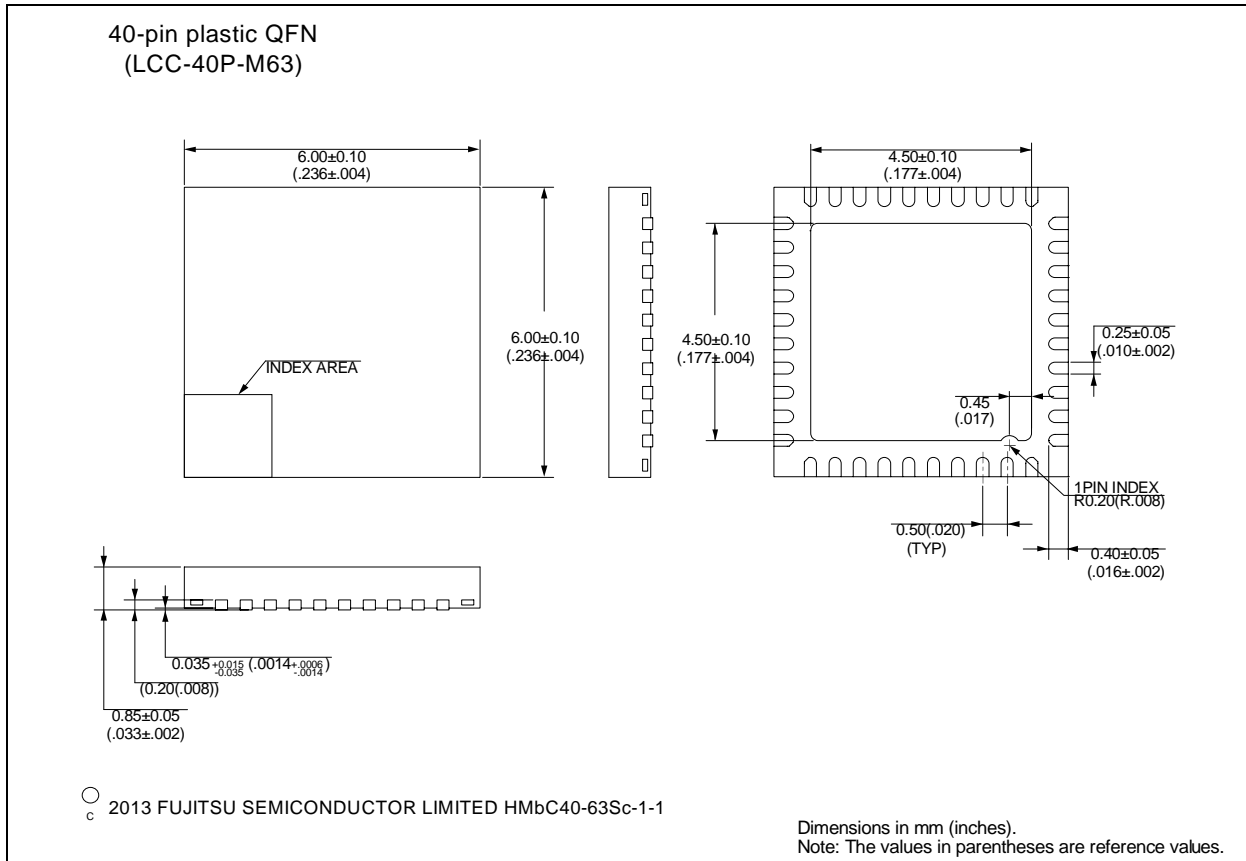
<p style="text-align: center;">40-pin plastic QFN</p>  <p style="text-align: center;">(LCC-40P-M63)</p>	Lead pitch	0.50 mm	
	Package width x package length	6.00 mm x 6.00 mm	
	Sealing method	Plastic mold	
	Mounting height	0.90 mm MAX	
	Weight	0.10 g	



18. Major Changes

Spancion Publication Number: MB39C811_DS405-00013....

Page	Section	Change Results
Preliminary 0.1 [June 14, 2013]		
-	-	Initial release
Revision 1.0 [November 18, 2013]		
6	4.Pin Assignments	Changed Pin8 PGND to N.C.
7	5.Pin Descriptions	Changed Pin8 PGND to N.C.
9	7.Absolute Maximum Rating	Added Max in Power dissipation
		Added Figure [Power dissipation]
		Changed VIN pin input slew rate
		Added VIN pin , Input current
		AddedAC pin input current
10	8.RecommendedOperatingConditions	Deleted Added VIN pin , Input current
		Deleted AC pin input current
11	9.1.DC Characteristics	Changed values in "Input voltage range"
		Deleted Input slew rate
		Added "IOUT=1mA" in "Preset output voltage" and changed values
		Changed "over current protection" to "peak switching current" and values
		Changed "Output current" to "Maximum output current" and values
		Changed values in "UVLO release voltage"
		Changed values in "UVLO detection voltage"
18	11.Example	Added new
22	14.OrderingInformation	Added "Table 14-2 EVB OrderingInformation"
23	15.Marking	Added new
24	16.Product Label	Added new
25	17.RecommendedMountingConditions	Added new
Revision 2.0 [August 29, 2014]		
11	9. Electrical Characteristics Table 9-1 DC characteristics	Deleted Input voltage range
18	11. Typical Application Circuits Figure 11-3 Voltage doubler rectification circuit for vibration harvester	Added the explanation of the voltage doubler rectification circuit
19 to 21	12. Application Notes	Added the "12. Application Notes"
22 to 26	13. Typical Characteristics	Updated the "13. Typical Characteristics"
27	14. Layout for Printed Circuit Board	Added the "14. Layout for Printed Circuit Board"
30 to 32	18. Product Label	Changed the "18. Product Label"
Revision 3.0		
7	5. Pin Descriptions	Added descriptions for all N.C. pins in "Table 5-1 Pin descriptions" "Non connection pin"→"Non connection pin (Leavethis pin open)"
8	6. Block Diagram	Wiring correction in "Figure 6-1 Block diagram" Deleted the wire connections between DCGND1, DCGND2 pins and each bridge rectifier, then added the internal GNDs.
11	9. Electrical Characteristics 9.1 DC characteristics	Addedconditions and notes for output power-good detection voltage in "Table 9-1 DC characteristics" "To preset voltage ratio"→"To preset voltage ratio $V_{VOUT} \geq 3.3V$ (*2)"
15	10. Function 10.3 Function descriptions	Addedconditions and notes in "Table 10-3 Output power-good signal output (OPGOOD)" " $\geq V_{OPGH}$ "→" $\geq V_{OPGH}$ ($V_{VOUT} \geq 3.3V$) (*1)"

Page	Section	Change Results
17	11. Typical Application Circuits	Wiring correction in "Figure 11-1 Application circuit for photovoltaic energy harvester" Deleted the wire connections between DCGND1 pin and the bridge rectifier, then added the internal GND.
17	11. Typical Application Circuits	Wiring correction in "Figure 11-2 Application circuit for vibration energy harvester" Deleted the wire connections between DCGND2 pin and the bridge rectifier, then added the internal GND.
18	11. Typical Application Circuits	Wiring correction in "Figure 11-3 Voltage doubler rectification circuit for vibration harvester" Deleted the wire connections between DCGND1 pin and the bridge rectifier, then added the internal GND.
19, 20	12. Application Notes	Added the "Table 12-1 Manufactures of recommended inductors" Added the "Table 12-2 Manufactures of photovoltaic harvesters" Added the "Table 12-3 Manufactures of vibration harvesters" Added the "Table 12-4 Manufactures of capacitors"
23 to 28	13. Typical Characteristics	Inserted the data of 22 μ H and 10 μ H together into "Figure 13-1 Typical characteristics of DC/DC conveter". Inserted the data of 22 μ H and 10 μ H together into "Figure 13-4 Switching waveforms of DC/DC converter".
23, 24	13. Typical Characteristics	Replaced the line regulation datas of 22 μ H in "Figure 13-1 Typical characteristics of DC/DC conveter" Replaced the load regulation datas of 22 μ H in "Figure 13-1" Added the line and load regulation data of 10 μ H in "Figure 13-1".
31	16. Ordering Information	Deleted "Table 16-2 EVB Ordering information"

NOTE: Please see "Document History" about later revised information.

Document History

Document Title: MB39C811 Ultra Low Power Buck PMIC Solar/Vibrations Energy Harvesting
Document Number: 002-08401

Revision	ECN	Orig. of Change	Submission Date	Description of Change
**	—	TAOA	12/05/2014	Migrated to Cypress and assigned document number 002-08401. No change to document contents or format.
*A	5124887	TAOA	02/22/2016	Updated to Cypress template

Sales, Solutions, and Legal Information

Worldwide Sales and Design Support

Cypress maintains a worldwide network of offices, solution centers, manufacturer's representatives, and distributors. To find the office closest to you, visit us at [Cypress Locations](#).

Products

Automotive	cypress.com/go/automotive
Clocks & Buffers	cypress.com/go/clocks
Interface	cypress.com/go/interface
Lighting & Power Control	cypress.com/go/powerpsoc
Memory	cypress.com/go/memory
PSoC	cypress.com/go/psoc
Touch Sensing	cypress.com/go/touch
USB Controllers	cypress.com/go/usb
Wireless/RF	cypress.com/go/wireless
Spanion Products	cypress.com/spanionproducts

PSoC® Solutions

psoc.cypress.com/solutions
[PSoC 1](#) | [PSoC 3](#) | [PSoC 4](#) | [PSoC 5LP](#)

Cypress Developer Community

[Community](#) | [Forums](#) | [Blogs](#) | [Video](#) | [Training](#)

Technical Support

cypress.com/go/support

© Cypress Semiconductor Corporation 2014-2016. This document is the property of Cypress Semiconductor Corporation and its subsidiaries, including Spanion LLC ("Cypress"). This document, including any software or firmware included or referenced in this document ("Software"), is owned by Cypress under the intellectual property laws and treaties of the United States and other countries worldwide. Cypress reserves all rights under such laws and treaties and does not, except as specifically stated in this paragraph, grant any license under its patents, copyrights, trademarks, or other intellectual property rights. If the Software is not accompanied by a license agreement and you do not otherwise have a written agreement with Cypress governing the use of the Software, then Cypress hereby grants you under its copyright rights in the Software, a personal, non-exclusive, nontransferable license (without the right to sublicense) (a) for Software provided in source code form, to modify and reproduce the Software solely for use with Cypress hardware products, only internally within your organization, and (b) to distribute the Software in binary code form externally to end users (either directly or indirectly through resellers and distributors), solely for use on Cypress hardware product units. Cypress also grants you a personal, non-exclusive, nontransferable, license (without the right to sublicense) under those claims of Cypress's patents that are infringed by the Software (as provided by Cypress, unmodified) to make, use, distribute, and import the Software solely to the minimum extent that is necessary for you to exercise your rights under the copyright license granted in the previous sentence. Any other use, reproduction, modification, translation, or compilation of the Software is prohibited. CYPRESS MAKES NO WARRANTY OF ANY KIND, EXPRESS OR IMPLIED, WITH REGARD TO THIS DOCUMENT OR ANY SOFTWARE, INCLUDING, BUT NOT LIMITED TO, THE IMPLIED WARRANTIES OF MERCHANTABILITY AND FITNESS FOR A PARTICULAR PURPOSE. Cypress reserves the right to make changes to this document without further notice. Cypress does not assume any liability arising out of the application or use of any product or circuit described in this document. Any information provided in this document, including any sample design information or programming code, is provided only for reference purposes. It is the responsibility of the user of this document to properly design, program, and test the functionality and safety of any application made of this information and any resulting product. Cypress products are not designed, intended, or authorized for use as critical components in systems designed or intended for the operation of weapons, weapons systems, nuclear installations, life-support devices or systems, other medical devices or systems (including resuscitation equipment and surgical implants), pollution control or hazardous substances management, or other uses where the failure of the device or system could cause personal injury, death, or property damage ("Unintended Uses"). A critical component is any component of a device or system whose failure to perform can be reasonably expected to cause the failure of the device or system, or to affect its safety or effectiveness. Cypress is not liable, in whole or in part, and Company shall and hereby does release Cypress from any claim, damage, or other liability arising from or related to all Unintended Uses of Cypress products. Company shall indemnify and hold Cypress harmless from and against all claims, costs, damages, and other liabilities, including claims for personal injury or death, arising from or related to any Unintended Uses of Cypress products.

Cypress, the Cypress logo, Spanion, the Spanion logo, and combinations thereof, PSoC, CapSense, EZ-USB, F-RAM, and Traveo are trademarks or registered trademarks of Cypress in the United States and other countries. For a more complete list of Cypress trademarks, visit cypress.com. Other names and brands may be claimed as property of their respective owners