

**PICDEM<sup>TM</sup> Touch Sense 1  
Development Board  
User's Guide**

---

**Note the following details of the code protection feature on Microchip devices:**

- Microchip products meet the specification contained in their particular Microchip Data Sheet.
- Microchip believes that its family of products is one of the most secure families of its kind on the market today, when used in the intended manner and under normal conditions.
- There are dishonest and possibly illegal methods used to breach the code protection feature. All of these methods, to our knowledge, require using the Microchip products in a manner outside the operating specifications contained in Microchip's Data Sheets. Most likely, the person doing so is engaged in theft of intellectual property.
- Microchip is willing to work with the customer who is concerned about the integrity of their code.
- Neither Microchip nor any other semiconductor manufacturer can guarantee the security of their code. Code protection does not mean that we are guaranteeing the product as "unbreakable."

Code protection is constantly evolving. We at Microchip are committed to continuously improving the code protection features of our products. Attempts to break Microchip's code protection feature may be a violation of the Digital Millennium Copyright Act. If such acts allow unauthorized access to your software or other copyrighted work, you may have a right to sue for relief under that Act.

---

Information contained in this publication regarding device applications and the like is provided only for your convenience and may be superseded by updates. It is your responsibility to ensure that your application meets with your specifications. MICROCHIP MAKES NO REPRESENTATIONS OR WARRANTIES OF ANY KIND WHETHER EXPRESS OR IMPLIED, WRITTEN OR ORAL, STATUTORY OR OTHERWISE, RELATED TO THE INFORMATION, INCLUDING BUT NOT LIMITED TO ITS CONDITION, QUALITY, PERFORMANCE, MERCHANTABILITY OR FITNESS FOR PURPOSE. Microchip disclaims all liability arising from this information and its use. Use of Microchip devices in life support and/or safety applications is entirely at the buyer's risk, and the buyer agrees to defend, indemnify and hold harmless Microchip from any and all damages, claims, suits, or expenses resulting from such use. No licenses are conveyed, implicitly or otherwise, under any Microchip intellectual property rights.

**Trademarks**

The Microchip name and logo, the Microchip logo, Accuron, dsPIC, KEELOQ, KEELOQ logo, MPLAB, PIC, PICmicro, PICSTART, PRO MATE, rPIC and SmartShunt are registered trademarks of Microchip Technology Incorporated in the U.S.A. and other countries.


FilterLab, Linear Active Thermistor, MXDEV, MXLAB, SEEVAL, SmartSensor and The Embedded Control Solutions Company are registered trademarks of Microchip Technology Incorporated in the U.S.A.

Analog-for-the-Digital Age, Application Maestro, CodeGuard, dsPICDEM, dsPICDEM.net, dsPICworks, dsSPEAK, ECAN, ECONOMONITOR, FanSense, In-Circuit Serial Programming, ICSP, ICEPIC, Mindi, MiWi, MPASM, MPLAB Certified logo, MPLIB, MPLINK, mTouch, PICkit, PICDEM, PICDEM.net, PICtail, PIC<sup>32</sup> logo, PowerCal, PowerInfo, PowerMate, PowerTool, REAL ICE, rLAB, Select Mode, Total Endurance, UNI/O, WiperLock and ZENA are trademarks of Microchip Technology Incorporated in the U.S.A. and other countries.

SQTP is a service mark of Microchip Technology Incorporated in the U.S.A.

All other trademarks mentioned herein are property of their respective companies.

© 2008, Microchip Technology Incorporated, Printed in the U.S.A., All Rights Reserved.

 Printed on recycled paper.

**QUALITY MANAGEMENT SYSTEM  
CERTIFIED BY DNV  
== ISO/TS 16949:2002 ==**

*Microchip received ISO/TS-16949:2002 certification for its worldwide headquarters, design and wafer fabrication facilities in Chandler and Tempe, Arizona; Gresham, Oregon and design centers in California and India. The Company's quality system processes and procedures are for its PIC<sup>®</sup> MCUs and dsPIC<sup>®</sup> DSCs, KEELOQ<sup>®</sup> code hopping devices, Serial EEPROMs, microperipherals, nonvolatile memory and analog products. In addition, Microchip's quality system for the design and manufacture of development systems is ISO 9001:2000 certified.*



# PICDEM™ TOUCH SENSE 1 DEVELOPMENT BOARD USER'S GUIDE

---

---

## Table of Contents

---

---

### **Chapter 1: Chapter 1. Introduction**

1.1 Introduction .....	5
1.2 Highlights .....	5
1.3 PICDEM™ Touch Sense 1 Development Kit Contents .....	5
1.4 PICDEM™ Touch Sense 1 Development Board Construction and Layout ....	5
1.5 mTouch™ Diagnostic Tool Overview .....	7

### **Chapter 2: Chapter 2. Getting Started**

2.1 Introduction .....	8
2.2 Highlights .....	8
2.3 Installing the mTouch™ Software Development Kit (SDK) and mTouch™ Diagnostic Tool .....	8
2.4 Using The PICDEM™ Touch Sense and mTouch™ Diagnostic Tool .....	8

### **Chapter 3: Chapter 3. Troubleshooting**

3.1 Introduction .....	16
3.2 Highlights .....	16
3.3 Common Problems .....	16

### **Appendix A. Hardware Schematics**

A.1 Introduction .....	18
------------------------	----



# PICDEM™ TOUCH SENSE 1 DEVELOPMENT BOARD USER'S GUIDE

---

---

## Preface

---

---

### NOTICE TO CUSTOMERS

All documentation becomes dated, and this manual is no exception. Microchip tools and documentation are constantly evolving to meet customer needs, so some actual dialogs and/or tool descriptions may differ from those in this document. Please refer to our web site ([www.microchip.com](http://www.microchip.com)) to obtain the latest documentation available.

Documents are identified with a “DS” number. This number is located on the bottom of each page, in front of the page number. The numbering convention for the DS number is “DSXXXXA”, where “XXXX” is the document number and “A” is the revision level of the document.

For the most up-to-date information on development tools, see the MPLAB® IDE on-line help. Select the Help menu, and then Topics to open a list of available on-line help files.

## INTRODUCTION

This chapter contains general information that will be useful to know before using the PICDEM™ Touch Sense 1 Development Board. Items discussed in this chapter include:

- Document Layout
- Conventions Used in this Guide
- Recommended Reading
- The Microchip Web Site
- Customer Support
- Document Revision History

## DOCUMENT LAYOUT

This document describes how to use the PICDEM™ Touch Sense 1 Development Board as a development tool to emulate and debug firmware. The manual layout is as follows:

- **Chapter 1. “Introduction”**
- **Chapter 2. “Getting Started”**
- **Chapter 3. “Troubleshooting”**
- **Appendix A. “Hardware Schematics”**

# PICDEM™ Touch Sense 1 Development Board User's Guide

## CONVENTIONS USED IN THIS GUIDE

This manual uses the following documentation conventions:

### DOCUMENTATION CONVENTIONS

Description	Represents	Examples
<b>Arial font:</b>		
Italic characters	Referenced books	<i>MPLAB® IDE User's Guide</i>
	Emphasized text	...is the <i>only</i> compiler...
Initial caps	A window	the Output window
	A dialog	the Settings dialog
	A menu selection	select Enable Programmer
Quotes	A field name in a window or dialog	"Save project before build"
Underlined, italic text with right angle bracket	A menu path	<u>File&gt;Save</u>
Bold characters	A dialog button	Click <b>OK</b>
	A tab	Click the <b>Power</b> tab
N'Rnnnn	A number in verilog format, where N is the total number of digits, R is the radix and n is a digit.	4'b0010, 2'hF1
Text in angle brackets < >	A key on the keyboard	Press <Enter>, <F1>
<b>Courier New font:</b>		
Plain Courier New	Sample source code	#define START
	Filenames	autoexec.bat
	File paths	c:\mcc18\h
	Keywords	_asm, _endasm, static
	Command-line options	-Opa+, -Opa-
	Bit values	0, 1
	Constants	0xFF, 'A'
Italic Courier New	A variable argument	<i>file.o</i> , where <i>file</i> can be any valid filename
Square brackets [ ]	Optional arguments	mcc18 [options] <i>file</i> [options]
Curly brackets and pipe character: {   }	Choice of mutually exclusive arguments; an OR selection	errorlevel {0 1}
Ellipses...	Replaces repeated text	var_name [, var_name...]
	Represents code supplied by user	void main (void) { ... }

## RECOMMENDED READING

This user's guide describes how to use the PICDEM™ Touch Sense 1 Development Board. Other useful documents are listed below. The following Microchip documents are available and recommended as supplemental reference resources.

### Readme Files

For the latest information on using other tools, read the tool-specific Readme files in the Readmes subdirectory of the MPLAB IDE installation directory. The Readme files contain update information and known issues that may not be included in this user's guide.

### Design Center

Microchip has a capacitive touch design center which can be found on [www.microchip.com/mtouch](http://www.microchip.com/mtouch).

The following Microchip Application Notes are available and recommended as supplemental reference resources.

AN1101, "*Introduction to Capacitive Sensing*" (DS01101)

AN1102, "*Layout and Physical Design Guidelines for Capacitive Sensing*" (DS01102)

AN1103, "*Software Handling for Capacitive Sensing*" (DS01103)

AN1104, "*Capacitive Multibutton Configurations*" (DS01104)

"*PICkit™ Serial Analyzer User's Guide*" (DS51647)

"*PICkit™ 2 User's Guide*" (DS51553)

Webseminar, "Introduction to mTouch™ Capacitive Touch Sensing"

Webseminar, "Capacitive mTouch™ Sensing Solutions: Design Guidelines"

## THE MICROCHIP WEB SITE

Microchip provides online support via our web site at [www.microchip.com](http://www.microchip.com). This web site is used as a means to make files and information easily available to customers. Accessible by using your favorite Internet browser, the web site contains the following information:

- **Product Support** – Data sheets and errata, application notes and sample programs, design resources, user's guides and hardware support documents, latest software releases and archived software
- **General Technical Support** – Frequently Asked Questions (FAQs), technical support requests, online discussion groups, Microchip consultant program member listing
- **Business of Microchip** – Product selector and ordering guides, latest Microchip press releases, listing of seminars and events, listings of Microchip sales offices, distributors and factory representatives

# PICDEM™ Touch Sense 1 Development Board User's Guide

---

---

## CUSTOMER SUPPORT

Users of Microchip products can receive assistance through several channels:

- Distributor or Representative
- Local Sales Office
- Field Application Engineer (FAE)
- Technical Support

Customers should contact their distributor, representative or field application engineer (FAE) for support. Local sales offices are also available to help customers. A listing of sales offices and locations is included in the back of this document.

Technical support is available through the web site at: <http://support.microchip.com>

## DOCUMENT REVISION HISTORY

### Revision A (February 2008)

- Initial Release of this Document.



# PICDEM™ TOUCH SENSE 1 DEVELOPMENT BOARD USER'S GUIDE

---

---

## Chapter 1. Introduction

---

---

### 1.1 INTRODUCTION

The PICDEM™ Touch Sense 1 Development Board and Diagnostic Tool provide a platform that introduces users to Microchip's Capacitive Touch Sensing Technology. An alternative to traditional mechanical push buttons, this system is completely sealed and has no mechanical components that will wear with time. Furthermore, the shape of the buttons is not critical, allowing designers the ability to add aesthetic diversity to their design. Most importantly, Microchip offers a royalty-free license along with a multitude of resources to aid in the development of your own mTouch™ applications.

The PICDEM™ Touch Sense 1 Development Board comes pre-programmed with a demonstration application to ease the user into Capacitive Touch Sensing using all of the board's features. For advanced users comfortable with the core concepts, the two onboard PIC™ Microcontrollers (MCUs) can be reprogrammed using a PICkit™ 2 programmer. The accompanying CD-ROM includes resource documentation such as a detailed description of the mTouch technology along with reference designs.

### 1.2 HIGHLIGHTS

This chapter discusses:

- PICDEM™ Touch Sense 1 Development Kit Contents
- PICDEM™ Touch Sense 1 Development Board Construction and Layout
- mTouch™ Diagnostic Tool Overview

### 1.3 PICDEM™ TOUCH SENSE 1 DEVELOPMENT KIT CONTENTS

The PICDEM™ Touch Sense 1 Development Kit contains the following items:

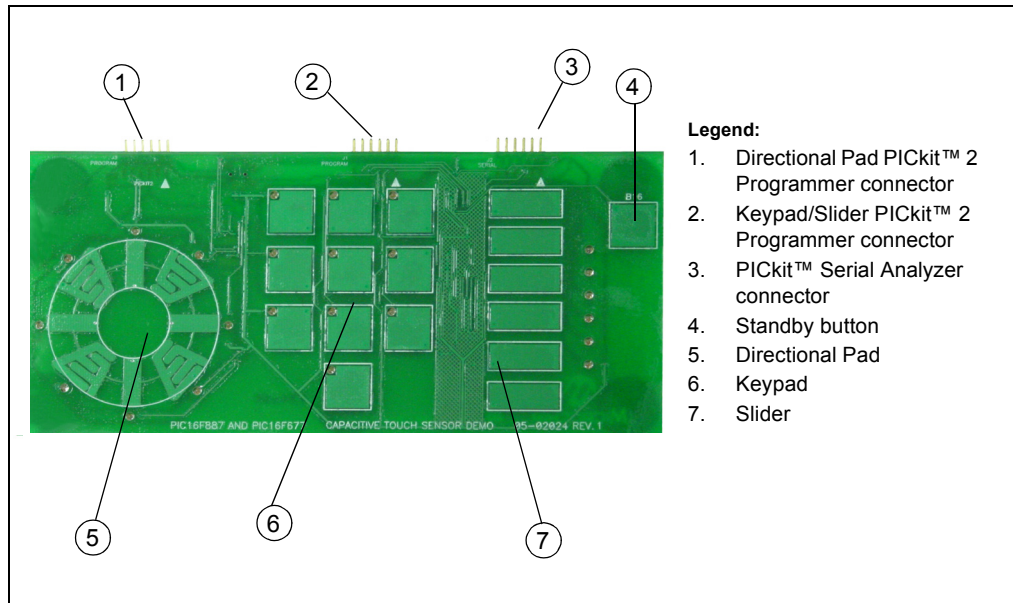
1. The PICDEM™ Touch Sense 1 Development Board
2. PICkit™ Serial Analyzer
3. USB cable
4. CD-ROM including:
  - mTouch™ Diagnostic Tool Software
  - Application Notes
  - Code Module Library
  - Reference Designs

### 1.4 PICDEM™ TOUCH SENSE 1 DEVELOPMENT BOARD CONSTRUCTION AND LAYOUT

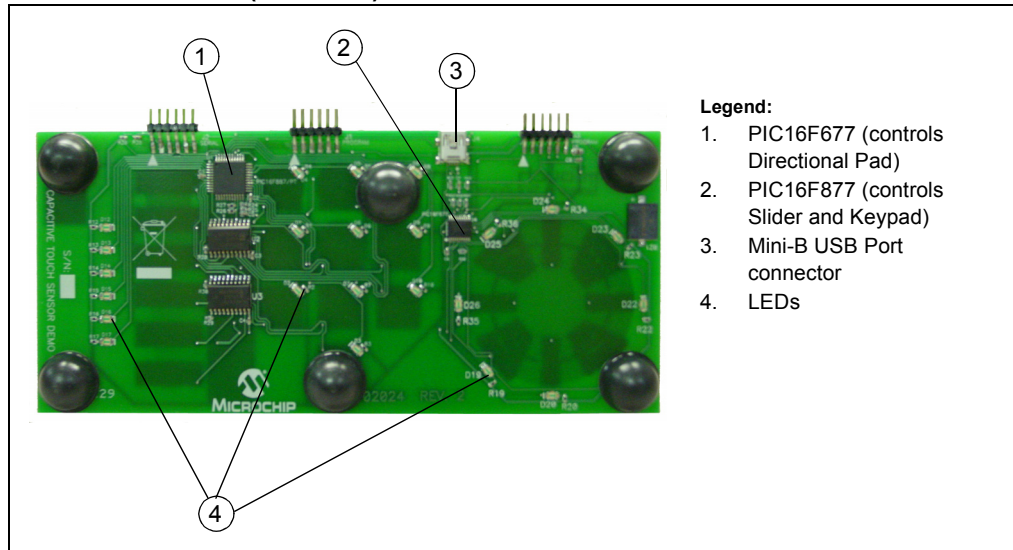
The PICDEM™ Touch Sense 1 Development Board is constructed using a two layer sandwich assembly. The bottom layer is the Printed Circuit Board (PCB) which holds all the electronic components as well as the touch sensors themselves (see Figure 1-1 and Figure 1-2).



**FIGURE 1-1: PICDEM™ TOUCH SENSE 1 DEVELOPMENT BOARD (TOP) WITHOUT SILK-SCREENED COVER PLATE**

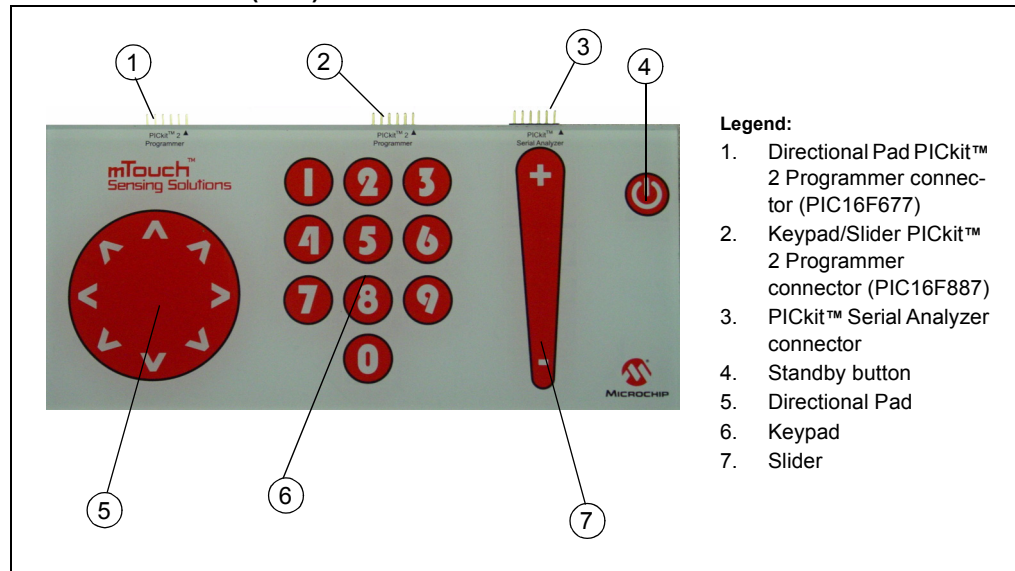


**FIGURE 1-2: PICDEM™ TOUCH SENSE 1 DEVELOPMENT BOARD (BOTTOM)**



Notice that all electronic components such as LEDs, PIC® Microcontrollers (MCUs) and multiplexer ICs are mounted on the bottom side of the board to create a flat surface to accommodate the top layer. A clear acrylic cover plate with a decorative silk screen is mounted over the PCB using a double-sided adhesive tape (see Figure 1-3).

**FIGURE 1-3: ASSEMBLED PICDEM™ SENSE 1 DEVELOPMENT BOARD (TOP)**



The PICDEM™ Touch Sense 1 Development Board features three styles of touch sensor pad configurations to optimize the design process:

- Directional pad
- Keypad
- Slider

The PICDEM™ Touch Sense 1 Development Board comes populated with a 20-pin PIC16F677 MCU and a 44-pin PIC16F887 MCU each with its own dedicated PICkit™ 2 Programmer Connector (see Figure 1-3). Each PIC MCU comes factory programmed with demonstration firmware and controls its own unique section of the PICDEM™ Touch Sense 1 Development Board. The PIC16F677 MCU is dedicated to the Directional Pad while the PIC16F887 MCU to both the Keypad and Slider. I<sup>2</sup>C™ serial communication between both MCUs is made possible using on-chip Master Synchronous Serial Port (MSSP) peripherals.

A PICkit™ Serial Connector is included to enable communication with the PICDEM™ Touch Sense 1 Development Board using the mTouch Diagnostic Tool.

## 1.5 mTouch™ DIAGNOSTIC TOOL OVERVIEW

The mTouch™ Diagnostic Tool is a Windows® based application that provides an intuitive means of analyzing a capacitive system. The mTouch Diagnostic Tool provides communication with the PICDEM™ Touch Sense 1 Development Board via the PICkit™ Serial Analyzer using the I<sup>2</sup>C protocol. Application critical information such as Trip threshold and acceptable hysteresis signaling a sensor touch can easily be determined by visualizing sensor behavior.

---

---

## Chapter 2. Getting Started

---

---

### 2.1 INTRODUCTION

This section provides an introduction to the PICDEM™ Touch Sense 1 Demonstration Board and mTouch™ Diagnostic Tool using the demonstration application firmware pre-programmed on the PIC® MCUs that populate the board. A more detailed discussion on the mTouch technology is provided in the *mTouch™ User's Guide (DS41328)* that can be found on the accompanying CD-ROM.

### 2.2 HIGHLIGHTS

This chapter discusses:

- Installing the mTouch Software Development Kit and Diagnostic Tool
- Using the PICDEM Touch Sense 1 and mTouch Diagnostic Tool

### 2.3 INSTALLING THE mTouch™ SOFTWARE DEVELOPMENT KIT (SDK) AND mTouch™ DIAGNOSTIC TOOL

Insert the PICDEM™ Touch Sense 1 CD-ROM into the CD-ROM drive. Browse to the CD-ROM directory and select setup.exe to install the Diagnostic Tool.

The mTouch™ SDK contains application notes related mTouch™, documentation such as the mTouch™ Users Guide, example designs and the mTouch™ Diagnostic Tool.

A working directory is generated during installation that will contain files associated with the mTouch diagnostic tool.

This directory can be accessed in C:\Program Files\Microchip\mTouch.

### 2.4 USING THE PICDEM™ TOUCH SENSE AND mTouch™ DIAGNOSTIC TOOL

#### 2.4.1 Target Power

The PICDEM™ Touch Sense 1 Demonstration Board can be powered in one of three ways:

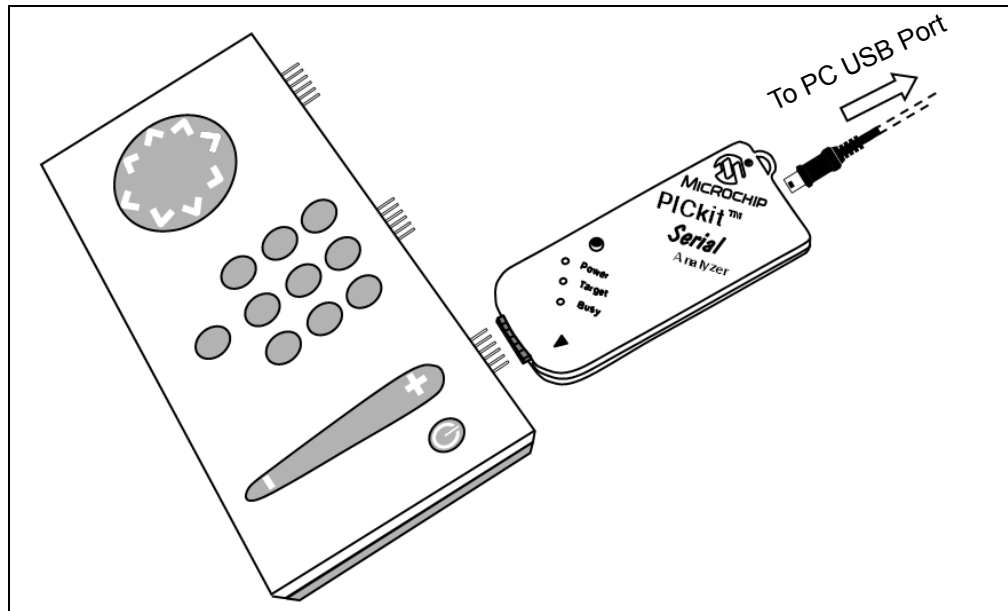
- The included USB cable connected to the USB Mini-B connector input provides power from a PC USB port. Note that this connection does not allow for any communication.
- A PICKit™ 2 Programmer connected to any one of the two PICKit™ 2 Programmer connectors.
- A PICKit™ Serial Analyzer connected to the of the PICKit™ Serial Analyzer connector.

This Getting Started Guide will use power provided by the PICKit™ Serial Analyzer.

#### 2.4.2 Connecting the PICDEM™ Touch Sense 1 Demonstration Board

Ensure that the PICDEM™ Touch Sense 1 Demonstration Board is sitting on a flat non-conductive surface. Connect the PICKit™ Serial Analyzer to the PICDEM™ Touch Sense 1 Demonstration Board and then to an available USB port on your PC as shown in Figure 2-2.

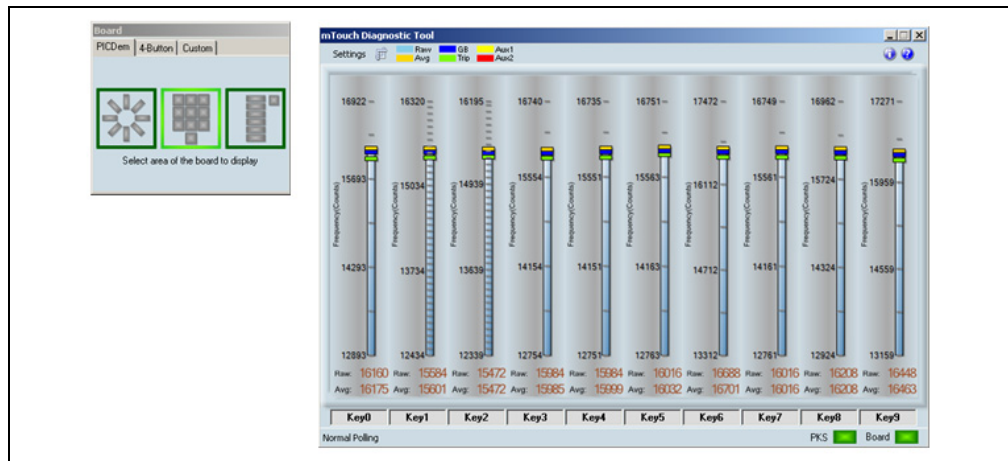
**FIGURE 2-1: CONNECTING THE PICDEM TOUCH SENSE 1 DEMONSTRATION BOARD**



## 2.4.3 Starting the mTouch Diagnostic Tool

Start the mTouch Diagnostic Tool by selecting Start>Programs>Microchip>mTouch. The mTouch Diagnostic Tool main window and Board Selection window should appear as shown in Figure 2-2.

**FIGURE 2-2: BOARD SELECTION AND mTOUCH DIAGNOSTIC TOOL WINDOWS**



Notice that the PICDEM™ Touch Sense 1 Demonstration Board is powered. All touch pad areas should now be functional with the associated LED lighting when a pad is touched. Also note that the individual touch pad activated is highlighted in both the Board Selection and mTouch Diagnostic Tool windows.

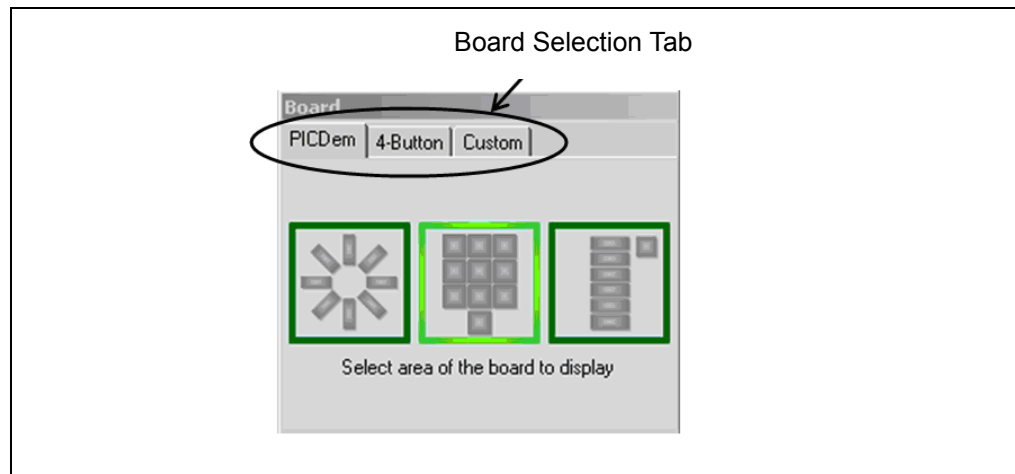
## 2.4.4 Board Selection

The Board Selection window allows user selection of three different board styles:

- PICDEM™ Touch Sense 1 Demonstration Board
- 4-Button Demonstration Board
- Custom board

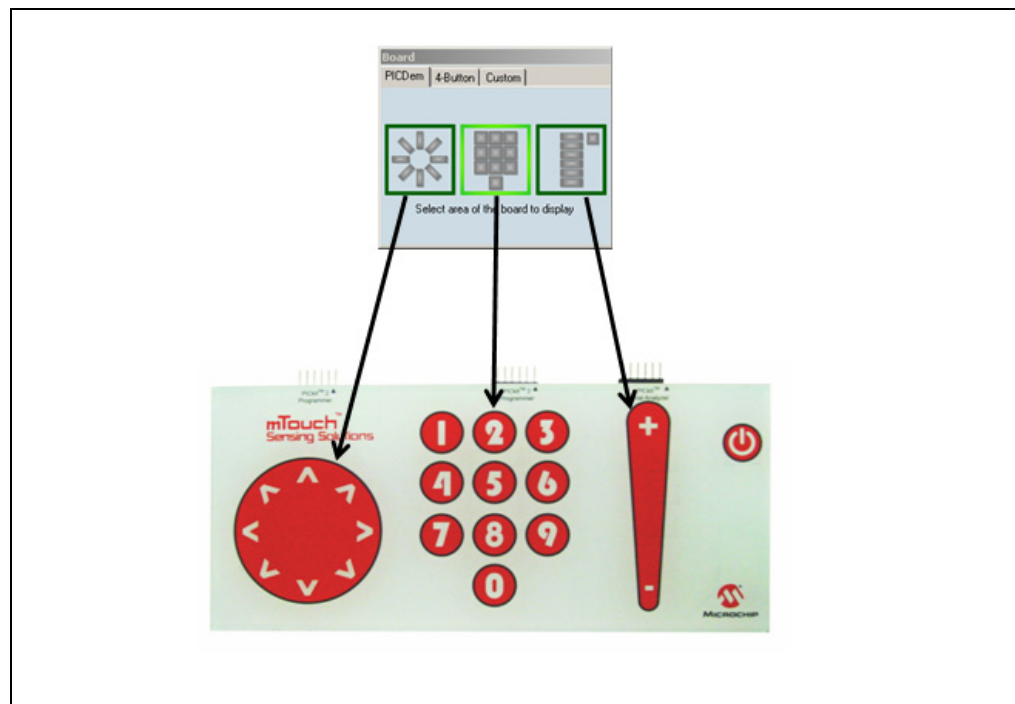
Ensure that the PICDEM™ Touch Sense 1 Demonstration Board is selected as shown in Figure 2-3.

**FIGURE 2-3: BOARD SELECTION TAB**



Each touch pad section on the PICDEM™ Touch Sense 1 Demonstration Board is represented in the Board Selection window as shown in Figure 2-4.

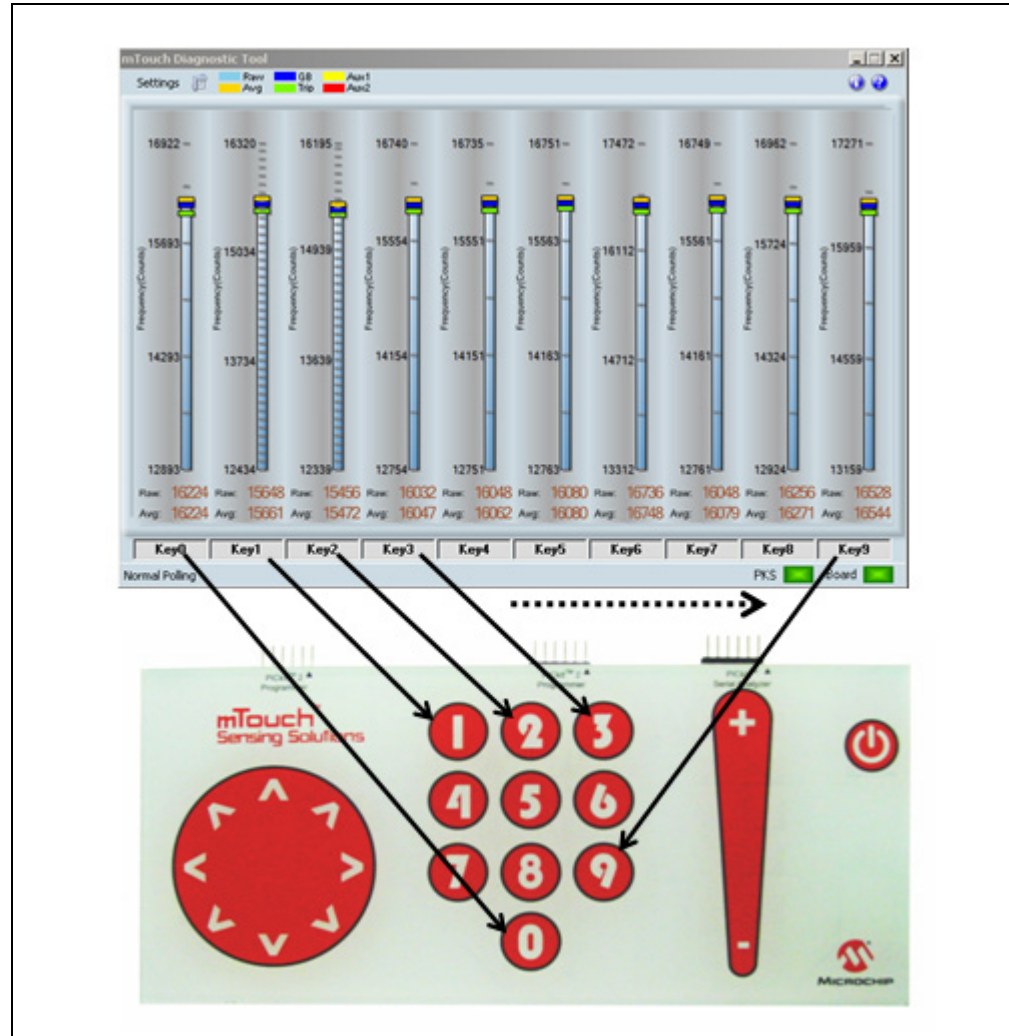
**FIGURE 2-4: BOARD SELECTION WINDOW TOUCH PAD SELECTION**



## 2.4.5 mTouch Diagnostic Tool Main Window

Selecting a touch pad section on the Board Selection window updates the main mTouch Diagnostic Tool window displaying gauges for individual touch pads in that section as shown in Figure 2-5.

**FIGURE 2-5: mTOUCH DIAGNOSTIC TOOL DISPLAY AND ASSOCIATED PAD WITH KEYPAD SECTION SELECTED IN BOARD SELECTION WINDOW**



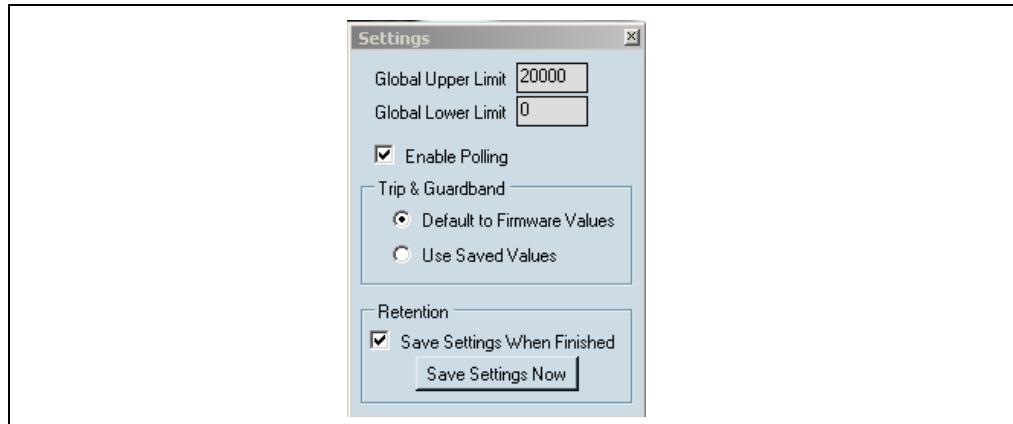
Individual gauge names can be altered from the default by clicking in the name window directly beneath the gauge.

Select the Keypad section of the PICDEM™ Touch Sense 1 Board in the Board Selection window. Touching the different touch pad sections, you should notice that only the Keypad in the Board Selection window shows activity. This confirms that the Demonstration Firmware Application is polling only the Keypad section and ignores the Directional Pad and Slider.

## 2.4.6 mTouch Diagnostic Tool Window Configuration

In the mTouch Diagnostic Tool window, select Settings. The Settings window shown in Figure 2-6 should now display.


**FIGURE 2-6: SETTINGS WINDOW**



In the Settings window change the value in the Global Limit window to 20000 and press the **Save Settings Now** button. The mTouch Diagnostic Tool window gauges should now all be scaled to a maximum upper limit of 20000 counts.

Deselect the Enable Polling feature in the Settings window to disable software polling of the individual Keypad Keys. Touching the Keypad now has no effect on the individual gauges in the mTouch Diagnostic Tool window. Select Enable Polling once again.

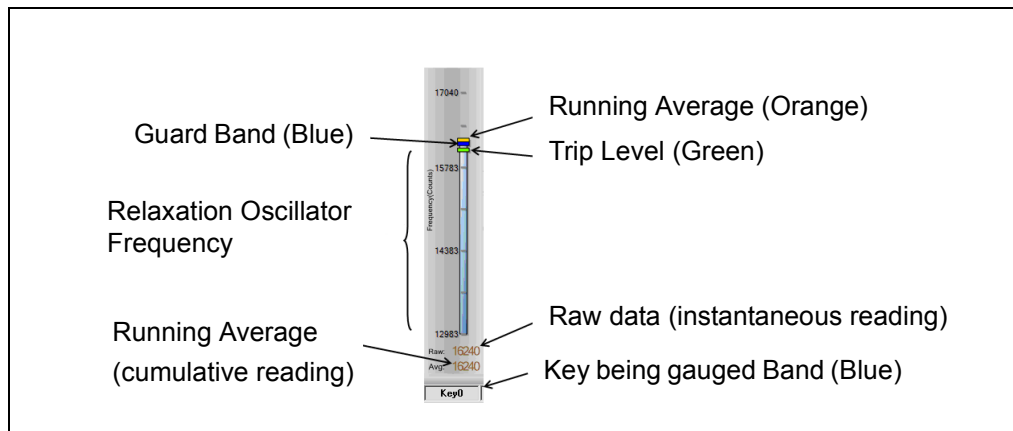
The Settings window also allows the user to save settings for the next time the tool is used.

Alternately, the **AutoScale** button  found at the top of the mTouch Diagnostic Tool window can be used to scale both Upper and Lower Limits based on current average values.

## 2.4.7 mTouch Diagnostic Tool Gauges

Each touch pad (Key '0' shown) on the PICDEM Touch Sense 1 Board is represented by its own individual gauge in the mTouch Diagnostic Tool window. This adjustable gauge can be used to either analyze and/or change functional characteristics of the associated pad as shown in Figure 2-7.

**FIGURE 2-7: GAUGE INFORMATION FOR KEYPAD KEY '0'**

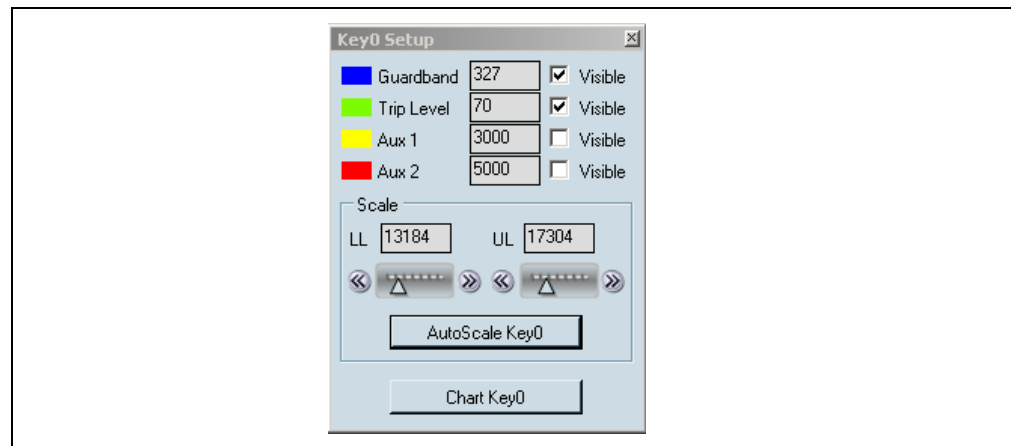


Guard Band and Trip Level parameters are easily changed by sliding their associated pointers up and down the gauge. The Guard Band provides a range of raw data values that will be included into the averaging algorithm of the demonstration software. Any raw data value below the Guard Band is not included. More information on software algorithms and other mTouch Technology related topics can be found in the mTouch User's Guide on the accompanying CD-ROM following installation of the mTouch SDK).

## 2.4.8 Individual Gauge Configuration Using the Setup Window

Alternately, gauges can be configured using the Setup window. Click on the gauge associated with Key '0' to open the Gauge Setup window shown in Figure 2-8.

**FIGURE 2-8: KEY '0' SETUP WINDOW**

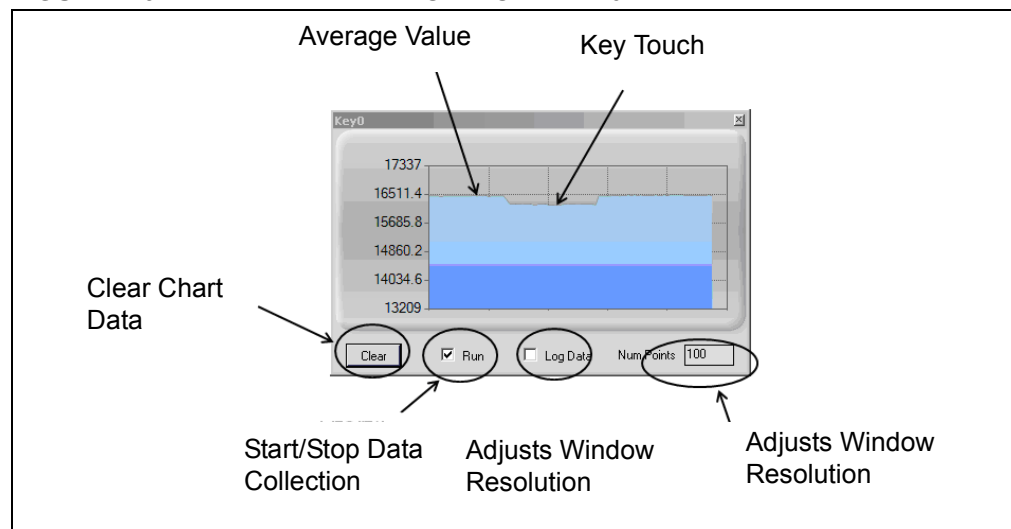


The Setup window allows customization of a particular gauge by numerically adjusting parameters such as Guard Band and Trip Level. Additionally, auxiliary pointers can be added to the gauge for other user determined references. The scale section of the window provides individual gauge scaling of both Upper (UL) and Lower Limits (LL) or by using the **AutoScale** button.

## 2.4.9 Charting Raw Data using the Chart Window

Click on the **Chart** button within the Setup window. The Chart window shown in Figure 2-9 should now be open.

**FIGURE 2-9: CHART WINDOW FOR KEY '0'**





The Chart window provides a visualization of the raw data for a particular touch pad as a function of time. Pressing Key '0' on the PICDEM Touch Sense 1 Board will cause the data line to dip providing that parameters are set accordingly as shown in Figure 9.

The resulting data can be stored as a .txt file within the working directory `C:\Program Files\Microchip\mTouch` and used for analytical purposes in such spreadsheet programs as Excel.

To stop recording data from the pad, deselect the check box next to Run.

The **Clear** button clears the data in the window.

Chart resolution can also be configured by changing the Num Points box value.

## **2.4.10 Directional Pad and Slider**

The preceding Getting Started guide demonstrated use of the keypad. These same concepts and tools are applicable to the Directional Pad and Slider. The user is encouraged to complete the Getting Started guide for both these sections as well.

# PICDEM™ Touch Sense 1 Development Board User's Guide

---

---

NOTES:

---

---

## Chapter 3. Troubleshooting

---

---

### 3.1 INTRODUCTION

This chapter describes common problems when using the PICDEM Touch Sense 1 Development Board and their solutions.

### 3.2 HIGHLIGHTS

Highlights covered in this chapter:

- Common Problems

### 3.3 COMMON PROBLEMS

#### 3.3.1 PICkit™ Serial Analyzer could not be found

Question:

I am receiving the error message, "PICkit™ Serial Analyzer could not be found" in the Transactions window, but the PICkit™ Serial Analyzer is plugged in. What is wrong?

Answer:

Open the Windows® operating system Device Manager by clicking on Control Panel > System, selecting the Hardware tab and clicking on **Device Manager** button. Check if there is an error displayed under Human Interface Devices as shown in Figure 13-1.

If an error is displayed, try unplugging and then re-plugging the USB cable until the error goes away (this may take 3 or 4 tries).

If the error persists, try another USB port or hub. Try plugging the PICkit™ Serial Analyzer into another computer to verify that the USB port is working.

#### 3.3.2 Current Limit Exceeded

Question:

I received the error message "USB Hub Current Limit Exceeded" from the Windows® operating system. What is wrong?

Answer:

The USB port current limit is set to 100 mA. If the target device plus PICkit™ Serial Analyzer exceeds this current limit, the USB port will shut down. Check for shorts. The target device can be externally powered if more power is needed.

#### 3.3.3 Microsoft® Windows® 98 SE

Question:

After plugging the PICkit™ Serial Analyzer into the USB port, Windows® 98 SE asks for a driver. Where is the driver?

Answer:

The PICkit™ Serial Analyzer uses the Human Interface Device (HID) driver included with the Windows® Operating System. When Windows® 98 SE prompts for a driver, select “Search for the best driver for your device.” Then select the check box next to “Microsoft Windows Update” and click **Next**. Windows will automatically install the appropriate driver. Do not use Microchip’s MPLAB® ICD 2 USB driver.

### **3.3.4 Microsoft® Windows® 95/98/NT**

Question:

Can I run on Windows® 95/98/NT?

Answer:

No. These operating systems either do not support USB or have drivers that are not compatible.

### **3.3.5 Can’t get projects to run**

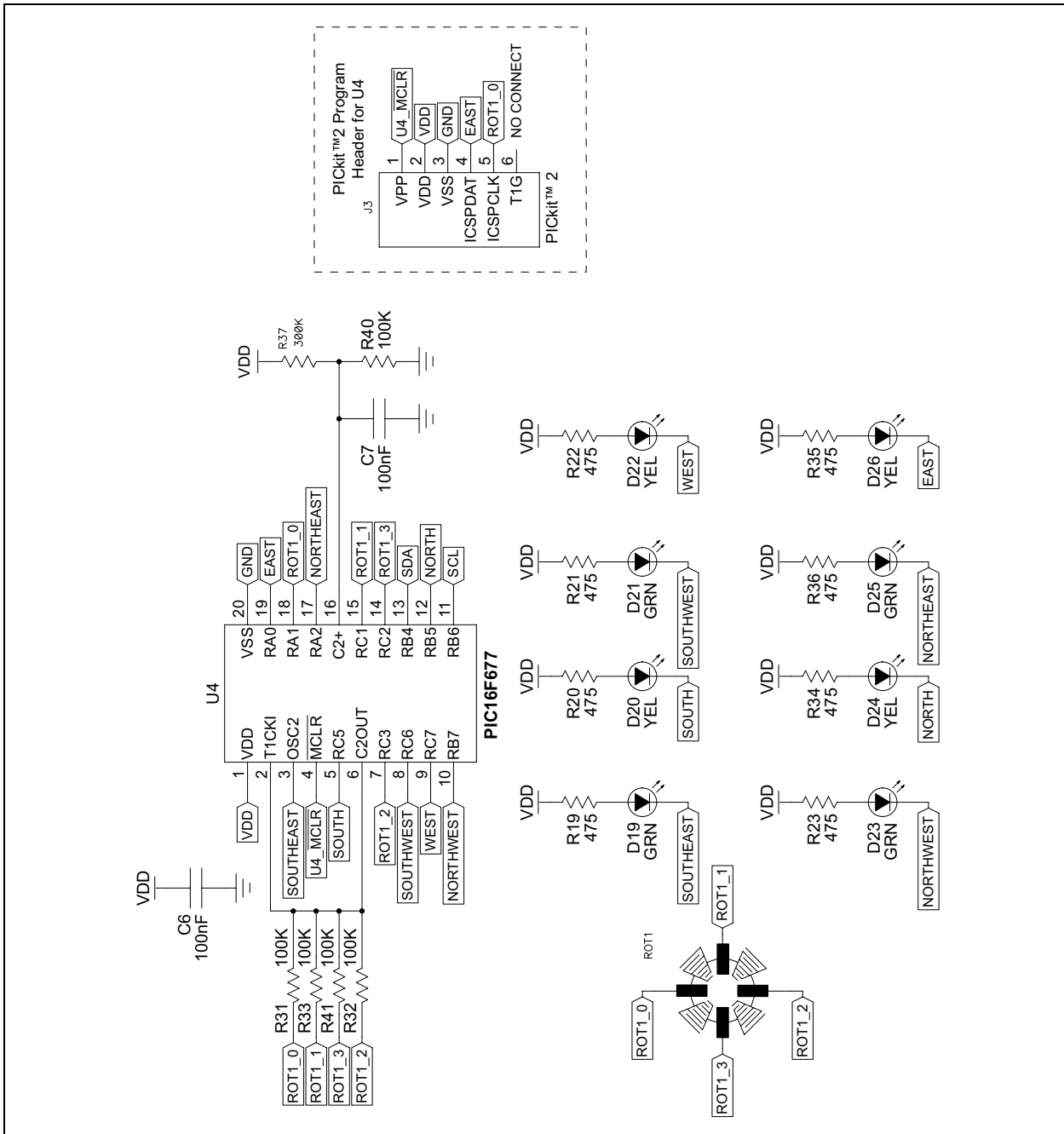
The projects are for use with the PICkit 2 and are compiled with the HI-TECH™ C compiler.

**Appendix A. Hardware Schematics**

**A.1 INTRODUCTION**

This appendix contains the PICDEM System Management Board hardware diagrams.

**FIGURE A-1: SCHEMATIC SHEET 1 – DIRECTIONAL PAD**



# PICDEM™ Touch Sense 1 Development Board User's Guide

FIGURE A-2: SCHEMATIC SHEET 2 – KEYPAD AND SLIDER

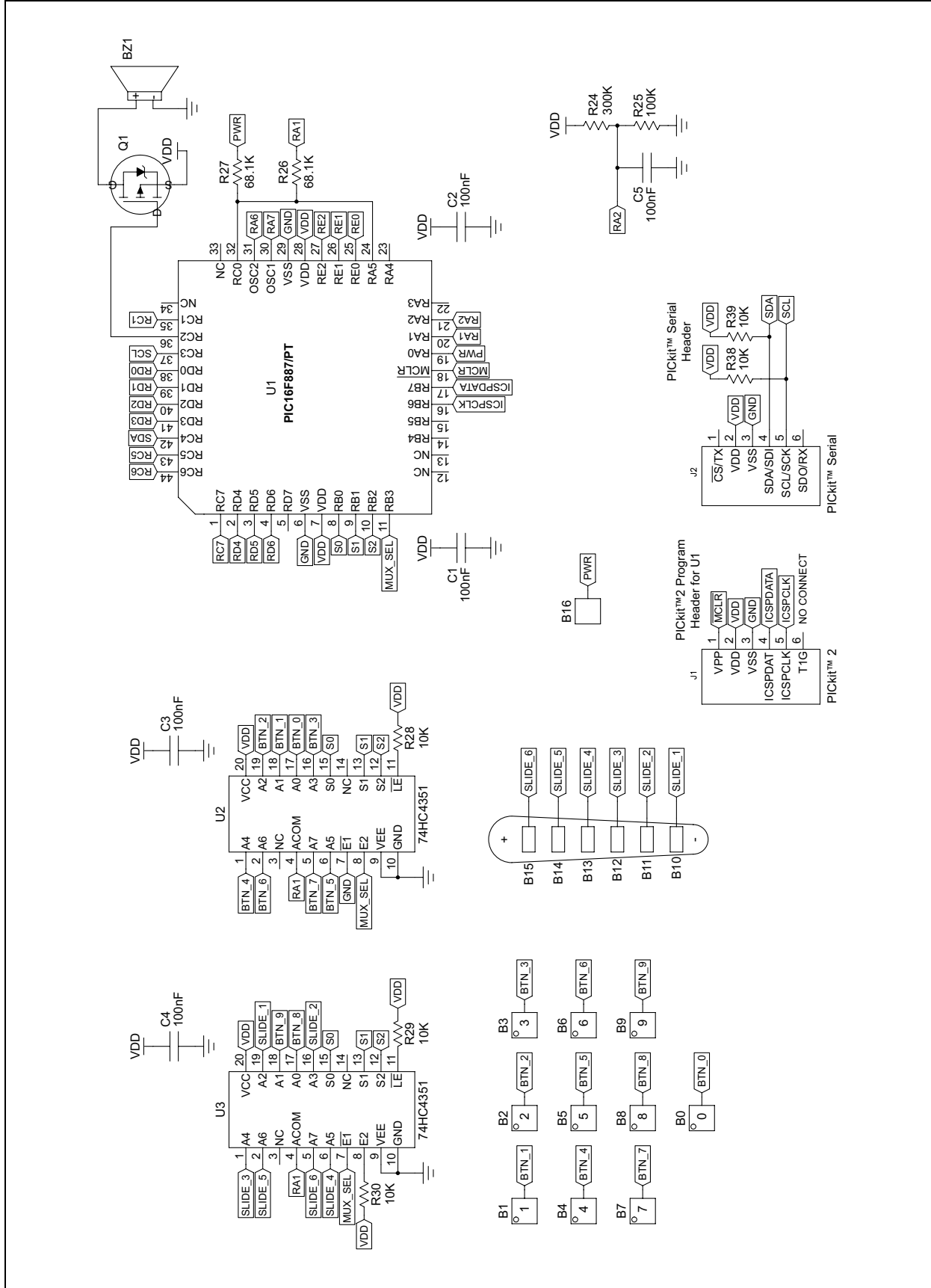
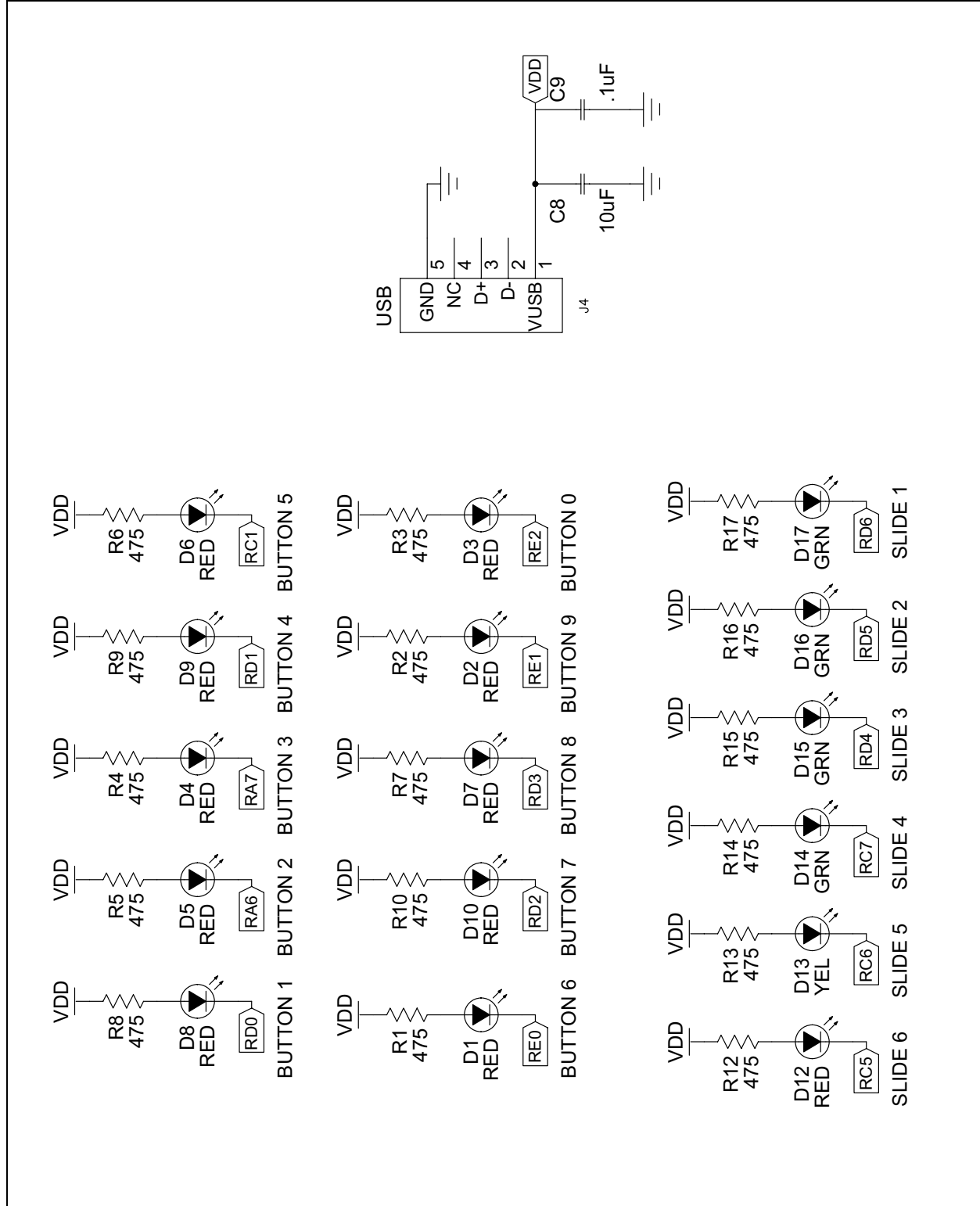


FIGURE A-3: SCHEMATIC SHEET 3 – LEDs



# PICDEM™ Touch Sense 1 Development Board User's Guide

---

---

NOTES:



# PICDEM™ Touch Sense 1 Development Board User's Guide

---

NOTES:



## WORLDWIDE SALES AND SERVICE

### AMERICAS

**Corporate Office**  
2355 West Chandler Blvd.  
Chandler, AZ 85224-6199  
Tel: 480-792-7200  
Fax: 480-792-7277  
Technical Support:  
<http://support.microchip.com>  
Web Address:  
[www.microchip.com](http://www.microchip.com)

**Atlanta**  
Duluth, GA  
Tel: 678-957-9614  
Fax: 678-957-1455

**Boston**  
Westborough, MA  
Tel: 774-760-0087  
Fax: 774-760-0088

**Chicago**  
Itasca, IL  
Tel: 630-285-0071  
Fax: 630-285-0075

**Dallas**  
Addison, TX  
Tel: 972-818-7423  
Fax: 972-818-2924

**Detroit**  
Farmington Hills, MI  
Tel: 248-538-2250  
Fax: 248-538-2260

**Kokomo**  
Kokomo, IN  
Tel: 765-864-8360  
Fax: 765-864-8387

**Los Angeles**  
Mission Viejo, CA  
Tel: 949-462-9523  
Fax: 949-462-9608

**Santa Clara**  
Santa Clara, CA  
Tel: 408-961-6444  
Fax: 408-961-6445

**Toronto**  
Mississauga, Ontario,  
Canada  
Tel: 905-673-0699  
Fax: 905-673-6509

### ASIA/PACIFIC

**Asia Pacific Office**  
Suites 3707-14, 37th Floor  
Tower 6, The Gateway  
Harbour City, Kowloon  
Hong Kong  
Tel: 852-2401-1200  
Fax: 852-2401-3431

**Australia - Sydney**  
Tel: 61-2-9868-6733  
Fax: 61-2-9868-6755

**China - Beijing**  
Tel: 86-10-8528-2100  
Fax: 86-10-8528-2104

**China - Chengdu**  
Tel: 86-28-8665-5511  
Fax: 86-28-8665-7889

**China - Hong Kong SAR**  
Tel: 852-2401-1200  
Fax: 852-2401-3431

**China - Nanjing**  
Tel: 86-25-8473-2460  
Fax: 86-25-8473-2470

**China - Qingdao**  
Tel: 86-532-8502-7355  
Fax: 86-532-8502-7205

**China - Shanghai**  
Tel: 86-21-5407-5533  
Fax: 86-21-5407-5066

**China - Shenyang**  
Tel: 86-24-2334-2829  
Fax: 86-24-2334-2393

**China - Shenzhen**  
Tel: 86-755-8203-2660  
Fax: 86-755-8203-1760

**China - Wuhan**  
Tel: 86-27-5980-5300  
Fax: 86-27-5980-5118

**China - Xiamen**  
Tel: 86-592-2388138  
Fax: 86-592-2388130

**China - Xian**  
Tel: 86-29-8833-7252  
Fax: 86-29-8833-7256

**China - Zhuhai**  
Tel: 86-756-3210040  
Fax: 86-756-3210049

### ASIA/PACIFIC

**India - Bangalore**  
Tel: 91-80-4182-8400  
Fax: 91-80-4182-8422

**India - New Delhi**  
Tel: 91-11-4160-8631  
Fax: 91-11-4160-8632

**India - Pune**  
Tel: 91-20-2566-1512  
Fax: 91-20-2566-1513

**Japan - Yokohama**  
Tel: 81-45-471- 6166  
Fax: 81-45-471-6122

**Korea - Daegu**  
Tel: 82-53-744-4301  
Fax: 82-53-744-4302

**Korea - Seoul**  
Tel: 82-2-554-7200  
Fax: 82-2-558-5932 or  
82-2-558-5934

**Malaysia - Kuala Lumpur**  
Tel: 60-3-6201-9857  
Fax: 60-3-6201-9859

**Malaysia - Penang**  
Tel: 60-4-227-8870  
Fax: 60-4-227-4068

**Philippines - Manila**  
Tel: 63-2-634-9065  
Fax: 63-2-634-9069

**Singapore**  
Tel: 65-6334-8870  
Fax: 65-6334-8850

**Taiwan - Hsin Chu**  
Tel: 886-3-572-9526  
Fax: 886-3-572-6459

**Taiwan - Kaohsiung**  
Tel: 886-7-536-4818  
Fax: 886-7-536-4803

**Taiwan - Taipei**  
Tel: 886-2-2500-6610  
Fax: 886-2-2508-0102

**Thailand - Bangkok**  
Tel: 66-2-694-1351  
Fax: 66-2-694-1350

### EUROPE

**Austria - Wels**  
Tel: 43-7242-2244-39  
Fax: 43-7242-2244-393

**Denmark - Copenhagen**  
Tel: 45-4450-2828  
Fax: 45-4485-2829

**France - Paris**  
Tel: 33-1-69-53-63-20  
Fax: 33-1-69-30-90-79

**Germany - Munich**  
Tel: 49-89-627-144-0  
Fax: 49-89-627-144-44

**Italy - Milan**  
Tel: 39-0331-742611  
Fax: 39-0331-466781

**Netherlands - Drunen**  
Tel: 31-416-690399  
Fax: 31-416-690340

**Spain - Madrid**  
Tel: 34-91-708-08-90  
Fax: 34-91-708-08-91

**UK - Wokingham**  
Tel: 44-118-921-5869  
Fax: 44-118-921-5820