



Application Note

AN_394

User Guide for FT260

Version 1.1

Issue Date: 2018-09-03

The FT260 is a USB device which supports I²C and UART communication through the standard USB HID interface. This guide describes the FT260 HID report formats, and is intended for developers who are creating applications, extending FTDI provided applications or implementing FTDI's applications for the FT260.

Use of FTDI devices in life support and/or safety applications is entirely at the user's risk, and the user agrees to defend, indemnify and hold FTDI harmless from any and all damages, claims, suits or expense resulting from such use.

Future Technology Devices International Limited (FTDI)

Unit 1, 2 Seaward Place, Glasgow G41 1HH, United Kingdom

Tel.: +44 (0) 141 429 2777 Fax: + 44 (0) 141 429 2758

Web Site: <http://ftdichip.com>

Copyright © Future Technology Devices International Limited

Table of Contents

1	Introduction	5
1.1	Overview	5
1.2	FT260 HID Interfaces and Endpoints.....	6
1.2.1	Interfaces	6
1.2.2	Endpoints	6
1.3	Scope	6
2	Wiring.....	7
2.1	I²C	7
2.2	UART	7
3	Getting Started	8
4	FT260 HID Reports	11
4.1	HID Class Requests for Reports.....	11
4.1.1	Get Report	11
4.1.2	Set Report	11
4.2	HID Report Structure	12
4.3	FT260 Report ID List	12
4.4	System Status Reports	13
4.4.1	Chip Version.....	13
4.4.2	Get System Status	13
4.4.3	Set System Clock.....	14
4.4.4	Set I ² C Mode	14
4.4.5	Set UART Mode.....	15
4.4.6	Enable Interrupt/Wake up	15
4.4.7	Select GPIO2 Function	16
4.4.8	Enable UART DCD RI	16
4.4.9	Select GPIOA Function	16
4.4.10	Select GPIOG Function.....	17
4.4.11	Set Interrupt Trigger Condition	17

4.4.12	Set Suspend Out Polarity	17
4.4.13	Enable UART RI Wakeup	18
4.4.14	Set UART RI Wakeup Config	18
4.4.15	I ² C Reset	18
4.4.16	Set I ² C Clock Speed	18
4.4.17	UART Reset	18
4.4.18	Configure UART	19
4.4.19	Set UART Baud Rate.....	20
4.4.20	Set UART Data Bit.....	21
4.4.21	Set UART Parity	21
4.4.22	Set UART Stop Bit	21
4.4.23	Set UART Breaking.....	21
4.4.24	Set UART XON / XOFF	22
4.5	I²C	22
4.5.1	Get I ² C Status.....	23
4.5.2	I ² C Write Request	23
4.5.3	I ² C Read Request	24
4.5.4	I ² C Input Report.....	25
4.6	UART	25
4.6.1	Get UART Settings	25
4.6.2	UART Write Request	26
4.6.3	UART Input Report.....	26
4.6.4	Get DCD & RI Status	27
4.7	GPIO	27
4.7.1	GPIO Write Request	27
4.7.2	GPIO Read Request.....	27
4.8	Interrupt Report.....	28
5	Sample Code to perform search with libudev.....	29
6	Contact Information	35
Appendix A	– References	36
	Document References	36

Acronyms and Abbreviations.....	36
Appendix B – List of Tables & Figures	37
List of Tables.....	37
List of Figures	37
Appendix C – Revision History	38

1 Introduction

1.1 Overview

The FT260 is a full speed USB device which supports I²C and UART communication through standard USB HID interfaces. The USB HID class is natively supported by most operating systems. A custom driver is not required to be installed for the FT260. By default, the FT260 has two HID interfaces:

- The first HID interface sends and receives data via the **I²C** connection.
- The second HID interface sends and receives data via the **UART** connection.
- The HID interface can be configured by the DCFN0 and DCFN1 pins.

The USB HID class exchanges data between a host and a device by reports. There are three types of reports in USB HID:

1. **Feature report:** Configuration data are exchanged between the host and the HID device through a control pipe. The feature report is usually used to turn on/off a device function.
2. **Input report:** Data content that is sent from the HID device to the host.
3. **Output report:** Data content that is sent from the host to the HID device.

The FT260 device receives output reports from the HID application, decodes the requests, and passes the data to the connected I²C or UART device. Data received from the I²C or UART device is sent to the host by input reports.

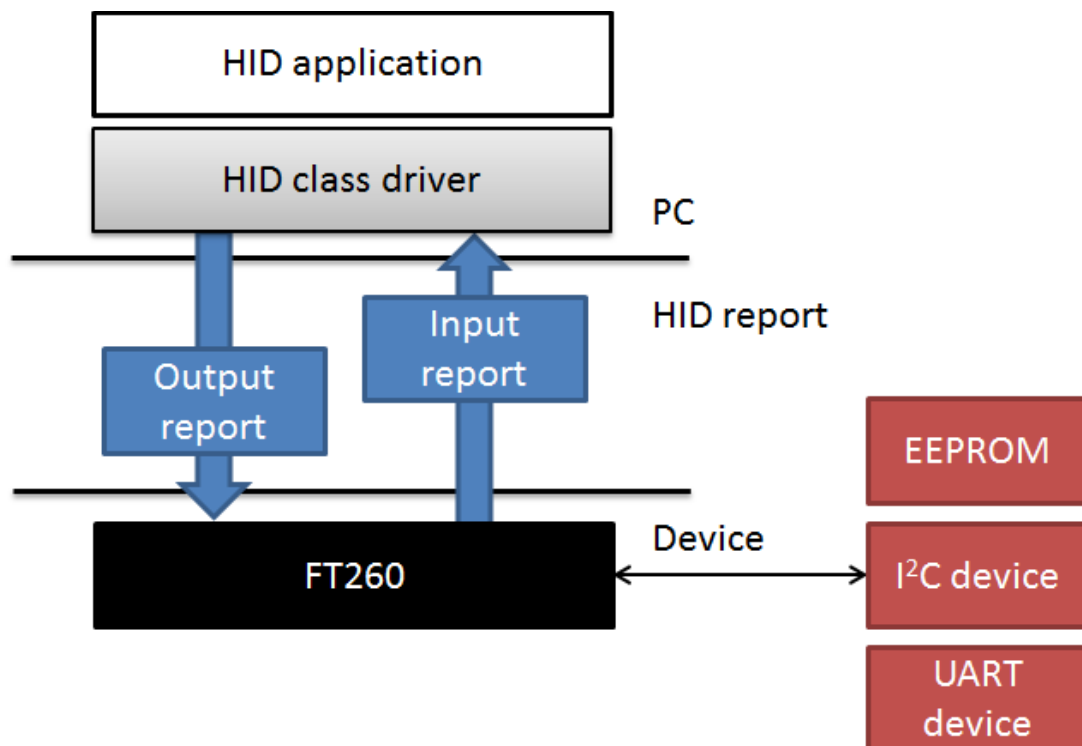

Figure 1.1 The FT260 System Block Diagram

1.2 FT260 HID Interfaces and Endpoints

1.2.1 Interfaces

The FT260 interfaces can be configured as:

- I²C and UART
- I²C only
- UART only

The interfaces can be configured by mode pins: DCNF0 and DCNF1.

DCNF1	DCNF0	HID Interfaces
0	0	The default mode. The FT260 will create two HID interfaces: I²C and UART . This mode is the same as mode (1,1).
0	1	The FT260 will create a HID interface which sends and receives data via the I²C connection.
1	0	The FT260 will create a HID interface which sends and receives data via the UART connection.
1	1	The FT260 will create two HID interfaces: <ul style="list-style-type: none"> • The first HID interface sends and receives data via the I²C connection. • The second HID interface sends and receives data via the UART connection.

Table 1.1 FT260 interface configuration

1.2.2 Endpoints

An interface of the FT260 is composed of the following endpoints:

Endpoint	Usage
Control In	Input reports, Feature reports sent to the host with a GET_REPORT request
Control Out	Output reports, Feature reports received from the host with a SET_REPORT request
Interrupt In	Input reports
Interrupt Out	Output reports

Table 1.2 FT260 endpoints

1.3 Scope

This guide describes the FT260 HID report formats, and is intended for developers who are creating applications, extending FTDI provided applications or implementing FTDI's applications for the FT260.

The sample source code contained in this application note is provided as an example and is neither guaranteed nor supported by FTDI.

2 Wiring

2.1 I²C

The FT260 I²C is open-drain architecture. It requires a suitable pull-high resistor on the I²C bus.

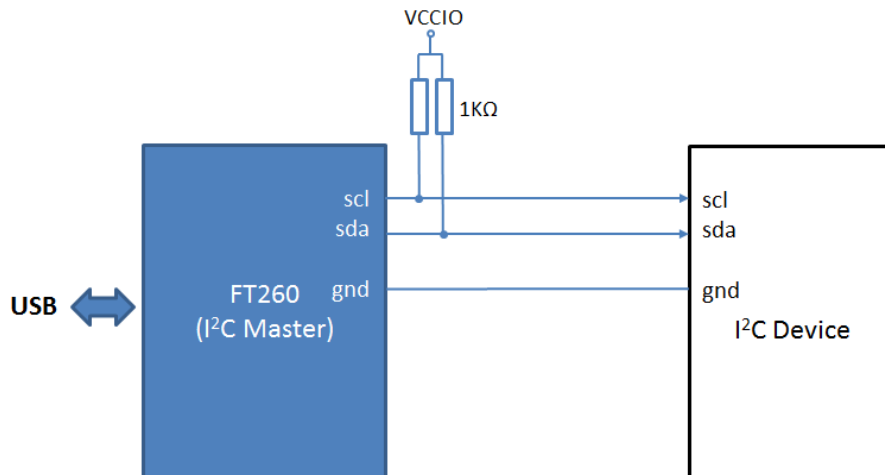

Figure 2.1 The FT260 connects with I²C bus

2.2 UART

The FT260 UART supports 4 flow control modes:

- Software flow control (default)
- Hardware flow control by CTS and RTS
- Hardware flow control by DTR and DSR
- No Flow Control

Software flow control mode is the default flow control mode of the FT260 and it has the simplest wiring. It only requires connecting TXD, RXD and GND. CTS, RTS, and DTR, DSR are optional for hardware flow control.

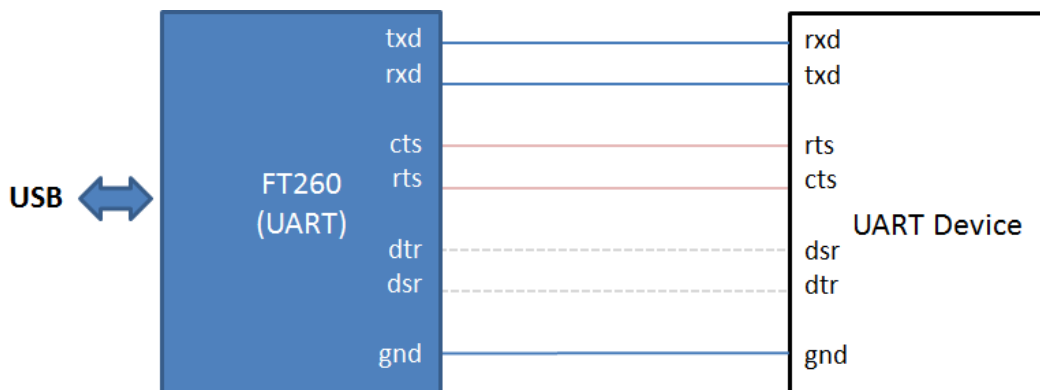

Figure 2.2 The FT260 connects to an UART device

3 Getting Started

This is a simple example which shows how to work with the FT260 on a Linux platform.

- Open the HID device by device path
- Get the info about the device driver using an ioctl function, which communicates with the underlying device driver, to get parameters.
- Send requests to the FT260

Example

```
#include <linux/types.h>
#include <linux/input.h>
#include <linux/hidraw.h>

/*
 * For the systems that don't have the new version of hidraw.h in userspace.
 */
#ifdef HIDIOCSFEATURE
#warning please have your distro update the userspace kernel headers
#define HIDIOCSFEATURE(len)   _IOC(_IOC_WRITE|_IOC_READ, 'H', 0x06, len)
#define HIDIOCGFEATURE(len)   _IOC(_IOC_WRITE|_IOC_READ, 'H', 0x07, len)
#endif

#include <sys/ioctl.h>
#include <sys/types.h>
#include <sys/stat.h>
#include <fcntl.h>
#include <unistd.h>

#include <stdio.h>
#include <string.h>
#include <stdlib.h>
#include <errno.h>

const char* bus_type_str(int bus) {
    switch (bus) {
        case BUS_USB:         return "USB";
        case BUS_HIL:         return "HIL";
        case BUS_BLUETOOTH:   return "Bluetooth";
        case BUS_VIRTUAL:     return "Virtual";
        default:               return "Other";
    }
}

int main(int argc, char **argv) {
    int fd;
    int res, desc_size = 0;
    char buf[256];
    struct hidraw_report_descriptor rpt_desc;
    struct hidraw_devinfo info;
    char* device = "/dev/hidraw0";

    if (argc > 1) {
        device = argv[1];
    }

    /* Open the Device with non-blocking reads. */
    /* It will be better if use libudev instead of hard coded path.
       You can check Appendix A for the example of using libudev */
```



```
fd = open(device, O_RDWR|O_NONBLOCK);

if (fd < 0) {
    perror("Unable to open device");
    return 1;
}

memset(&rpt_desc, 0x0, sizeof(rpt_desc));
memset(&info, 0x0, sizeof(info));
memset(buf, 0x0, sizeof(buf));

/* Get Report Descriptor Size */
res = ioctl(fd, HIDIOCGRDESCSIZE, &desc_size);
if (res < 0) {
    perror("HIDIOCGRDESCSIZE");
} else {
    printf("Report Descriptor Size: %d\n", desc_size);
}

/* Get Raw Name */
res = ioctl(fd, HIDIOCGRAWNAME(256), buf);
if (res < 0) {
    perror("HIDIOCGRAWNAME");
} else {
    printf("Raw Name: %s\n", buf);
}

/* Get Raw Info */
res = ioctl(fd, HIDIOCGRAWINFO, &info);
if (res < 0) {
    perror("HIDIOCGRAWINFO");
} else {
    printf("Raw Info:\n");
    printf("\tbustype: %d (%s)\n",
           info.bustype, bus_type_str(info.bustype));
    printf("\tvendor: 0x%04hx\n", info.vendor);
    printf("\tproduct: 0x%04hx\n", info.product);
}

/* Set Feature */
buf[0] = 0xA1; /* SYSTEM_SETTING_ID */
buf[1] = 0x22; /* I2C_SPEED */
buf[2] = 0x01; /* 400Kbps */
buf[3] = 0x90;
res = ioctl(fd, HIDIOCSFEATURE(4), buf);
if (res < 0) {
    perror("HIDIOCSFEATURE");
} else {
    printf("ioctl HIDIOCSFEATURE returned: %d\n", res);
}

/* Send a Report to the Device */
buf[0] = 0xD0; /* I2C write */
buf[1] = 0x22; /* Slave address */
buf[2] = 0x06; /* Start and Stop */
buf[3] = 0x03; /* data len */
buf[4] = 'a';
buf[5] = 'b';
buf[6] = 'c';
res = write(fd, buf, 7);
if (res < 0) {
```

```
        printf("Error: %d\n", errno);
        perror("write");
    } else {
        printf("write() wrote %d bytes\n", res);
    }

    close(fd);
    return 0;
}
```

4 FT260 HID Reports

The USB HID class exchanges data between a host and a device by reports, which are the actual data. There are three types of reports:

1. **Feature report:** Configuration data are exchanged between the host and the HID device through a control pipe. The feature report is usually used to turn on/off a device function.
2. **Input report:** Data that is sent from the HID device to the host.
3. **Output report:** Data that is sent from the host to the HID device.

The FT260 device receives output reports from the HID application, decodes the requests, and passes the data to the connected I²C or UART device. Or, it receives data from the I²C or UART device and sends the data to the host via input reports.

Please note that according to the USB HID spec, only one report is allowed in a single USB transfer and the report size of the FT260 is limited to 64 bytes, including a Report ID. If you have data larger than 64 bytes, including a Report ID and payload header, it must be separated into continuous HID reports for transfer.

4.1 HID Class Requests for Reports

The HID class-specific requests allow the host to enquire about the capabilities and state of the FT260 and to set the state of the output and feature items. These transactions are done over the Control pipe. In the FT260, only feature reports can be got or set via the control pipe, i.e. HID class-specific requests.

4.1.1 Get Report

The Get_Report request allows the host to receive a report via the Control pipe.

4.1.1.1 The setup packet

Offset	Field	Size	Description
0	bmRequestType	1	Bits specifying characteristics of request. 10100001b
1	bRequest	1	GET_REPORT (0x01)
2	wValue	2	Report Type (high byte) : Feature (0x03) Report ID (low byte)
4	wIndex	2	Interface
6	wLength	2	Report Length

4.1.1.2 The Data stage

The HID report will be received in the data stage.

4.1.2 Set Report

The Set_Report request allows the host to send a report to the device, possibly setting the state of input, output, or feature controls.

4.1.2.1 The setup packet

Offset	Field	Size	Description
0	bmRequestType	1	Bits specifying characteristics of request. 00100001b
1	bRequest	1	SET_REPORT (0x09)
2	wValue	2	Report Type (high byte): Feature (0x03) Report ID (low byte)
4	wIndex	2	Interface
6	wLength	2	Report Length

4.1.2.2 The Data stage

The HID report will be transferred in the data stage.

4.2 HID Report Structure

The first byte of a HID report is the Report ID, and it is followed by the data payload.

The USB HID class allows a device to define multiple report structures. In order to indicate which data fields are represented in each report structure, the first byte of report structures is assigned to be a Report ID, a 1-byte identification prefix to each report transfer. The details of the FT260 report structures will be illustrated in the following sections.

4.3 FT260 Report ID List

Here is the list of report IDs supported by the FT260. The detailed data structure of each report is described in the following sections.

Report ID	Type	Description
0xA0	Feature	Chip code
0xA1	Feature	System Setting
0xB0	Feature	GPIO
0xB1	Input	Interrupt Status (from UART interface)
0xC0	Feature	I ² C Status
0xC2	Output	I ² C Read Request
0xD0 to 0xDE	Input, Output	I ² C Report
0xE0	Feature	UART Status
0xE2	Feature	UART RI and DCD Status
0xF0 to 0xFE	Input, Output	UART Report

4.4 System Status Reports

4.4.1 Chip Version

Direction: Feature In

Offset	Field	Description
Byte 0	Report ID	0xA0
Bytes 1-4	Chip code	FTDI chip identification code For example, it could be: 0260 0200. 0260 is the chip part number. 0200 is the version control number. The 3rd byte, 02, is the minor version, and 4th byte, 00, is the major version.
Bytes 5-12	Reserved	Reserved

4.4.2 Get System Status

Direction: Feature In

Offset	Field	Description
Byte 0	Report ID	0xA1
Byte 1	chip_mode	DCNF0 and DCNF1 pin status Bit0: the value of DCNF0 Bit1: the value of DCNF1
Byte 2	clk_ctl	0: 12 MHz 1: 24 MHz 2: 48 MHz
Byte 3	suspend_status	Suspend status 0: the FT260 is not suspended 1: the FT260 is suspended
Byte 4	pwren_status	PWREN status, which indicates the FT260 is ready to use (after USB enumeration) 0: the FT260 is not ready to use, i.e. suspended, or before USB enumeration. 1: the FT260 is ready to use.
Byte 5	i2c_enable	0: I ² C is disabled 1: I ² C is enabled
Byte 6	uart_mode	0: OFF; UART pins act as GPIO 1: RTS_CTS mode 2: DTR_DSR mode 3: XON_XOFF (software flow control) 4: No flow control mode
Byte 7	hid_over_i2c_enable	0: The HID-over-I ² C feature is not configured. 1: The HID-over-I ² C feature is configured, and the FT260 is operating as a HID-over-I ² C bridge.
Byte 8	gpio2_function	0: GPIO 1: SUSPOUT 2: PWREN# (active-low) 4: TX_LED
Byte 9	gpioA_function	0: GPIO 3: TX_ACTIVE 4: TX_LED
Byte 10	gpioG_function	0: GPIO 2: PWREN# (active-low) 5: RX_LED 6: BCD_DET

Byte 11	suspend_out_pol	0: Suspend output active-high 1: Suspend output active-low
Byte 12	enable_wakeup_int	0: Disabled. The pin acts as GPIO3. 1: Enabled. The pin acts as wakeup/interrupt.
Byte 13	intr_cond	Bit [1:0] The trigger condition of the interrupt pin 00b: rising edge 01b: level (high) 10b: falling edge 11b: level (low) Bit [3:2] Interrupt level duration select. When the interrupt level exceeds the trigger level for the specified duration, the interrupt signal will be generated. 01b: 1 ms 10b: 5 ms 11b: 30 ms
Byte 14	enable_power_saving	If power saving mode is enabled and the FT260 is idle for 5 seconds, it will switch the system clock to 30 kHz to save power. 0: disable power saving 1: enable power saving
Byte 15 to byte 25	reserved	reserved

4.4.3 Set System Clock

Direction: Feature Out

Offset	Field	Description
Byte 0	Report ID	0xA1
Byte 1	request	0x01: Set Clock
Byte 2	clk_ctl	0: 12 MHz 1: 24 MHz 2: 48 MHz

4.4.4 Set I²C Mode

Direction: Feature Out

Offset	Field	Description
Byte 0	Report ID	0xA1
Byte 1	request	0x02: Set I2C Mode
Byte 2	enable_i2c_mode	0: Disable I2C mode. This configures I2C pins to GPIO, where DIO5 is configured as GPIO0 and DIO6 is configured as GPIO1. 1: Enable I2C mode. DIO5 is configured as SCL and DIO6 is configured as SDA.

4.4.5 Set UART Mode

Direction: Feature Out

Offset	Field	Description
Byte 0	Report ID	0xA1
Byte 1	request	0x03: Set UART Mode
Byte 2	enable_uart_mode	0: OFF, and switch UART pins to GPIO 1: RTS_CTS mode (GPIOB =>RTSN, GPIOE =>CTSN) 2: DTR_DSR mode (GPIOF =>DTRN, GPIOH => DSRN) 3: XON_XOFF (software flow control) 4: No flow control mode

Flow control is used to control the flow of data and prevent buffer overrun if a device cannot accept more data. It is also sometimes termed 'handshaking'. There are 3 main settings for flow control as described below.

4.4.5.1 Hardware flow control (RTS_CTS, DTR_DSR)

This setting uses the RTS# and CTS# lines. The RTS# line of one device (A) drives the CTS# line of the other device (B) and vice versa. If the RTS# line of device (A) is active it is stating the device (A) is able to accept more data by driving the CTS# input of the device (B) at the other end of the link active. Otherwise device (B) should stop transmitting.

4.4.5.2 Software flow control (XON_XOFF)

This setting uses special characters to start and stop data flow. These are termed XON and XOFF (from "transmit on" and "transmit off", respectively). The XON character tells the downstream device to start send data. The XOFF character tells the downstream device to stop sending data. Usually it is possible to define these characters in an application. The default value for XON is 0x11 and for XOFF is 0x13. To change the values, please refer to section 4.4.24.

4.4.5.3 No flow control mode

This setting does not use flow control at all and relies on the application or device being able to move data fast enough to prevent overrun.

4.4.6 Enable Interrupt/Wake up

Direction: Feature Out

Offset	Field	Description
Byte 0	Report ID	0xA1
Byte 1	request	0x05: Enable Interrupt/Wake up
Byte 2	enable	0: disable wakeup/interrupt and switch pin to GPIO3 1: enable wakeup/interrupt and disable GPIO3

4.4.7 Select GPIO2 Function

Direction: Feature Out

Offset	Field	Description
Byte 0	Report ID	0xA1
Byte 1	request	0x06: Select GPIO2 Function
Byte 2	function	The active function of the pin GPIO2: 0: GPIO 1: SUSPOUT 2: PWREN# (active-low) 4: TX_LED

The pin GPIO2 can be configured as the following functions:

- **GPIO**, General Purpose I/O.
- **SUSPOUT** is the suspend indicator when the USB enters suspend state. By default it is active low. It can be configured as active high.
- **PWREN** is the power enable indicator when FT260 is USB enumerated. It is active low.
- **TX_LED** is the LED driving source when data is transmitted on UART TX port.

4.4.8 Enable UART DCD RI

Direction: Feature Out

Offset	Field	Description
Byte 0	Report ID	0xA1
Byte 1	request	0x07: Enable UART DCD RI
Byte 2	enable	0: disable UART DCD, UART RI, and switch pin to GPIO4, GPIO5 1: enable and switch pin to UART DCD, UART RI

4.4.9 Select GPIOA Function

Direction: Feature Out

Offset	Field	Description
Byte 0	Report ID	0xA1
Byte 1	request	0x08: Select GPIOA Function
Byte 2	function	The active function of the pin GPIOA: 0: GPIO 3: TX_ACTIVE 4: TX_LED

The pin GPIOA can be configured as the following functions:

- **GPIO**, General Purpose I/O.
- **TX_ACTIVE** is the default function to indicate the UART transmitter is active.
- **TX_LED** is the LED driving source when data is transmitted on the UART TX port.

4.4.10 Select GPIOG Function

Direction: Feature Out

Offset	Field	Description
Byte 0	Report ID	0xA1
Byte 1	request	0x09: Select GPIOG Function
Byte 2	function	The active function of the pin GPIOG: 0: GPIO 2: PWREN# (active-low) 5: RX_LED 6: BCD_DET

The pin GPIOG can be configured as the following functions:

- **GPIO**, General Purpose I/O.
- **PWREN** is the power enable indicator when FT260 is USB enumerated. It is active low.
- **RX_LED** is the LED driving source when data is transmitted on the UART RX port.
- **BCD_DET** is the default function as the battery charger detection indicator output when the device is connected to a dedicated battery charger port.

4.4.11 Set Interrupt Trigger Condition

Direction: Feature Out

Offset	Field	Description
Byte 0	Report ID	0xA1
Byte 1	request	0x0A: Set Interrupt Trigger Condition
Byte 2	intr_type	Interrupt type: 0: rising edge 1: level (high) 2: falling edge 3: level (low)
Byte 3	delay	Interrupt level width select. When the interrupt level exceeds the trigger level for the specified duration, the interrupt signal will be generated. This setting only takes effect when intr_type = level (high or low). 1: 1ms 2: 5ms 3: 30ms

4.4.12 Set Suspend Out Polarity

Direction: Feature Out

Offset	Field	Description
Byte 0	Report ID	0xA1
Byte 1	request	0x0B: Set Suspend Out Polarity
Byte 2	polarity	0: Suspend output active-high 1: Suspend output active-low

4.4.13 Enable UART RI Wakeup

Direction: Feature Out

Offset	Field	Description
Byte 0	Report ID	0xA1
Byte 1	request	0x0C: Enable UART RI Wakeup
Byte 2	enable	0: disable 1: enable UART RI remote wakeup capability.

4.4.14 Set UART RI Wakeup Config

Direction: Feature Out

Offset	Field	Description
Byte 0	Report ID	0xA1
Byte 1	request	0x0D: Set UART RI Wakeup Config
Byte 2	config	Set UART RI remote wake up type. 0 : rising edge 1 : falling edge (default)

4.4.15 I²C Reset

Direction: Feature Out

Offset	Field	Description
Byte 0	Report ID	0xA1
Byte 1	request	0x20: I ² C Reset

The request will reset the I²C master controller.

4.4.16 Set I²C Clock Speed

Direction: Feature Out

Offset	Field	Description
Byte 0	Report ID	0xA1
Byte 1	request	0x22: Set I ² C Clock Speed
Byte 2	speed_LSB	The speed of I ² C clock, whose range is from 60K bps to 3400K bps.
Byte 3	speed_MSB	

Clock Speed is the frequency of the I²C bus clock in kilohertz (KHz). It's a two-byte number. For example, if the target clock speed is 100K, the LSB will be 0x64 and the MSB will be 0x00. If the target clock speed is 1000K (1M), the LSB will be 0xE8 and the MSB will be 0x03. If the given clock speed is not supported, the clock speed will fallback to 100K.

4.4.17 UART Reset

Direction: Feature Out

Offset	Field	Description
Byte 0	Report ID	0xA1
Byte 1	request	0x40: UART Reset

The request will reset the FT260 UART controller.

4.4.18 Configure UART

Direction: Feature Out

Offset	Field	Description
Byte 0	Report ID	0xA1
Byte 1	request	0x41: Configure UART
Byte 2	flow_ctrl	0: OFF, and switch UART pins to GPIO 1: RTS_CTS mode (GPIOB =>RTSN, GPIOE =>CTSN) 2: DTR_DSR mode (GPIOF =>DTRN, GPIOH => DSRN) 3: XON_XOFF (software flow control) 4: No flow control mode
Byte 3 to byte 6	baud_rate	UART baud rate, which is unsigned int, little-endian. e.g. 9600 = 0x2580 => [0x80, 0x25, 0x00, 0x00] 19200 = 0x4B00 => [0x00, 0x4B, 0x00, 0x00] The FT260 UART supports baud rate range from 1200 to 12M.
Byte 7	data_bit	The number of data bits: 0x07: 7 data bits 0x08: 8 data bits
Byte 8	parity	0: No parity 1: Odd parity. This means that the parity bit is set to either '1' or '0' so that an odd number of 1's are sent 2: Even parity. This means that the parity bit is set to either '1' or '0' so that an even number of 1's are sent 3: High parity. This simply means that the parity bit is always High 4: Low parity. This simply means that the parity bit is always Low
Byte 9	stop_bit	The number of stop bits: 0: one stop bit 2: two stop bits
Byte 10	breaking	When active the TXD line goes into 'spacing' state which causes a break in the receiving UART. 0: no break 1: break

4.4.18.1 UART Baud Rate Calculation

The UART can support baud rates from 1.2 Kbaud to 12 Mbaud defined by the following function.

$$\text{Baud Rate} = \frac{\text{Operating Clock Frequency}}{\text{Baud Divisor}}$$

The baud divisor is used to divide the operating clock frequency to the desired baud rate. It can take any value between 4 and 40000 with the added option of adding a fractional component in the order of 1/8ths.

Example: To generate an 115200 baud rate in the FT260, the operating clock frequency to the UART controller equals to 48MHz. The baud divisor can be calculated as shown in the below equation.

$$\text{Baud Divisor} = \frac{48\text{MHz}}{115200\text{Hz}} = 416.667$$

Due to the fractional component is the order of 1/8ths, the baud divisor must be selected as 416.625. It is obvious that the difference of baud divisors will produce a percentage error. A comparison of standard baud rates and the divisor values can be seen in table below. This shows

the baud rate required, followed by the divisor value needed to achieve this if the UART is running off a 48MHz clock. Then it lists the actual baud rate achieved and finally the percentage error this produces.

Target Baud Rate	Ideal Baud Divisor	Actual Baud Divisor	Actual Baud Rate	Baud Error Rate
12,000,000	4	4	12,000,000	0.00%±0.25%*Note
9,600,000	5	5	9,600,000	0.00%±0.25%
8,000,000	6	6	8,000,000	0.00%±0.25%
6,000,000	8	8	6,000,000	0.00%±0.25%
3,000,000	16	16	3,000,000	0.00%±0.25%
2,000,000	24	24	2,000,000	0.00%±0.25%
1,500,000	32	32	1,500,000	0.00%±0.25%
1,000,000	48	48	1,000,000	0.00%±0.25%
921,600	52.08 $\bar{3}$	52	923,076.9231	0.16%±0.25%
460,800	104.1 $\bar{6}$	104.125	460,984.3938	0.04%±0.25%
230,400	208. $\bar{3}$	208.250	230,492.1969	0.04%±0.25%
115,200	416. $\bar{6}$	416.625	115,211.5212	0.01%±0.25%
57,600	833. $\bar{3}$	833.250	57,605.7606	0.01%±0.25%
38,400	1,250	1250	38,400	0.00%±0.25%
19,200	2,500	2500	19,200	0.00%±0.25%
9,600	5,000	5000	9,600	0.00%±0.25%
4,800	10,000	10000	4,800	0.00%±0.25%
2,400	20,000	20000	2,400	0.00%±0.25%
1,200	40,000	40000	1,200	0.00%±0.25%

Table 4.1 Baud Rate Comparison

Note: The baud error rate with ±0.25% is from the internal oscpll.

4.4.19 Set UART Baud Rate

Direction: Feature Out

Offset	Field	Description
Byte 0	Report ID	0xA1
Byte 1	request	0x42: Set UART Baud Rate
Byte 2 to byte 5	baud_rate	UART baud rate, which is unsigned int, little-endian. e.g. 9600 = 0x2580 => [0x80, 0x25, 0x00, 0x00] 19200 = 0x4B00 => [0x00, 0x4B, 0x00, 0x00] The FT260 UART supports baud rate range from 1200 to 12M.

4.4.20 Set UART Data Bit

Direction: Feature Out

Offset	Field	Description
Byte 0	Report ID	0xA1
Byte 1	request	0x43: Set UART Data Bit
Byte 2	data_bit	The number of UART data bits: 0x07: 7 data bits 0x08: 8 data bits

4.4.21 Set UART Parity

Direction: Feature Out

Offset	Field	Description
Byte 0	Report ID	0xA1
Byte 1	request	0x44: Set UART Parity
Byte 2	parity	0: No parity 1: Odd parity. This means that the parity bit is set to either '1' or '0' so that an odd number of 1's are sent 2: Even parity. This means that the parity bit is set to either '1' or '0' so that an even number of 1's are sent 3: High parity. This simply means that the parity bit is always High 4: Low parity. This simply means that the parity bit is always Low

4.4.22 Set UART Stop Bit

Direction: Feature Out

Offset	Field	Description
Byte 0	Report ID	0xA1
Byte 1	request	0x45: Set UART Stop Bit
Byte 2	stop_bit	The number of stop bits: 0: one stop bit 2: two stop bits

4.4.23 Set UART Breaking

Direction: Feature Out

Offset	Field	Description
Byte 0	Report ID	0xA1
Byte 1	request	0x46: Set UART Breaking
Byte 2	breaking	When active the TXD line goes into 'spacing' state which causes a break in the receiving UART. 0: no break 1: break

4.4.24 Set UART XON / XOFF

Direction: Feature Out

Offset	Field	Description
Byte 0	Report ID	0xA1
Byte 1	request	0x49: Set UART XON / XOFF
Byte 2	XON char	Character to be used for XON flow control
Byte 3	XOFF char	Character to be used for XOFF flow control

4.5 I²C

I²C (Inter Integrated Circuit) is a multi-master serial bus invented by Philips. I²C uses two bi-directional open-drain wires called serial data (SDA) and serial clock (SCL). Common I²C bus speeds are the 100 kbit/s standard mode (SM), 400 kbit/s fast mode (FM), 1 Mbit/s Fast mode plus (FM+), and 3.4 Mbit/s High Speed mode (HS).

I²C transaction

All I²C transactions begin with a START condition, a slave address, a single bit representing write (0) or read (1), and are terminated by a STOP condition. All transactions are controlled by the master.

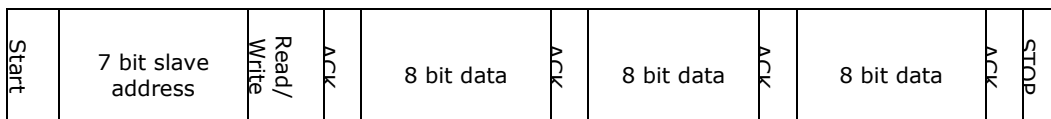

I²C defines three basic types of message:

- Single message where a master writes data to a slave;
- Single message where a master reads data from a slave;
- Combined messages, where a master issues at least two reads and/or writes to one or more slaves

For more information on the protocol, refer to the I²C specification.

The FT260 provides flexibility to allow users to decide when to send START and STOP conditions. Here are some examples. The following scenarios are supported by the FT260.

Send data with START_AND_STOP conditions

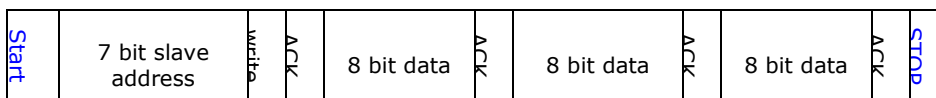

Send the first packet with START condition, and then send remaining data in the other packet with STOP condition.

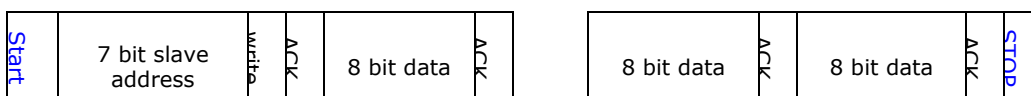

Separate data into three packets.

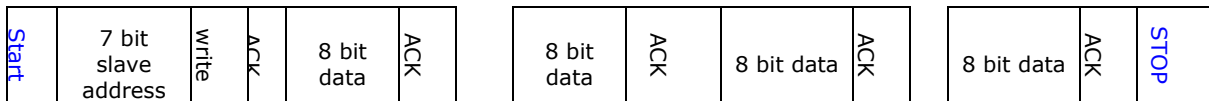

I²C combined message

In a combined message, each read or write begins with a START and the slave address. After the first START, these are also called repeated START bits; repeated START bits are not preceded by STOP bits, which is how slaves know the next transfer is part of the same message.

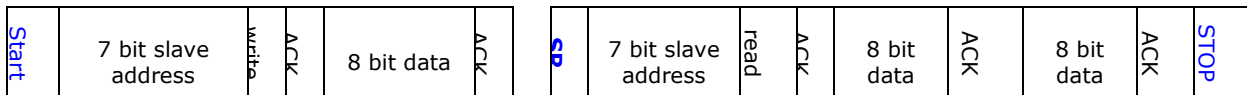

SR = repeated START condition

4.5.1 Get I²C Status

Direction: Feature In

Offset	Field	Description
Byte 0	Report ID	0xC0
Byte 1	bus status	I ² C bus status: <ul style="list-style-type: none"> bit 0 = controller busy: all other status bits invalid bit 1 = error condition bit 2 = slave address was not acknowledged during last operation bit 3 = data not acknowledged during last operation bit 4 = arbitration lost during last operation bit 5 = controller idle bit 6 = bus busy
Byte 2	speed_LSB	The speed of I ² C transmission. It ranges from 60K bps to 3400K bps. Clock Speed is the frequency of the I ² C bus clock in kilohertz (kHz). It's a two-byte number
Byte 3	speed_MSB	
Byte 4	reserved	reserved

4.5.2 I²C Write Request

Direction: Interrupt Out

Offset	Field	Description
Byte 0	Report ID	0xD0 – 0xDE The report ID determines the length of the data payload, in multiples of 4 bytes. 0xD0 : maximum data size is 4 bytes 0xD1 : maximum data size is 8 bytes 0xD2 : maximum data size is 12 bytes ... 0xDE : maximum data size is 60 bytes
Byte 1	slaveAddr	The address (7-bit) of the I ² C slave device
Byte 2	flag	The I ² C condition to be sent with this I ² C transaction: <ul style="list-style-type: none"> 0: None

		<ul style="list-style-type: none"> • 0x02: START • 0x03: Repeated_START Repeated_START will not send master code in HS mode • 0x04: STOP • 0x06: START_AND_STOP
Byte 3	length	The length of valid data of payload.
Byte 4 to Byte 63	data	The data payload. The maximum size of the data payload is determined by the report ID: (Report ID - 0xD0 + 1) * 4

Maximum Data Payload Size

The packet size of a HID report is fixed, the FT260 defines a series of report IDs for sending I²C write request with different packet size.

For example, the report ID 0xDE defines a 64 bytes packet, which is composed of 4 bytes header and 60 bytes data payload.

If the data is larger than 60 bytes, it cannot be sent in one packet. The data must be divided and sent in continuous packets.

However, if the data to be sent is only a few bytes, 60 bytes payload seems wasteful.

The FT260 defines a series of report IDs with data payload sizes in multiples of 4. Starting from report ID 0xD0, which defines 4 bytes data payload, the next report ID 0xD1 defines 8 bytes data payload, until report ID 0xDE which defines 60 bytes data payload.

The length field indicates the number of valid bytes in the data payload. For example, if you have 5 bytes to send, you can choose report ID 0xD1, which has 8 bytes payload, and set the length field to 5.

4.5.3 I²C Read Request

Direction: Interrupt Out

Offset	Field	Description
Byte 0	Report ID	0xC2
Byte 1	slaveAddr	The address (7-bit) of the I ² C slave device
Byte 2	flag	The I ² C condition will be sent with this I ² C transaction <ul style="list-style-type: none"> • 0: None • 0x02: START • 0x03: Repeated_START Repeated_START will not send master code in HS mode • 0x04: STOP • 0x06: START_AND_STOP
Byte 3 and byte 4	length	The number of bytes requested from the slave device. The byte order is little endian.

Reading data from an I²C slave device will be completed in two steps:

1. Send an I²C read request.
2. Receive data in one or more I²C input reports.

After receiving the read request, the FT260 I²C master controller will query data from the given slave, and send the data back to the host via interrupt in and I²C input reports.

4.5.4 I²C Input Report

Direction: Interrupt In

Offset	Field	Description
Byte 0	Report ID	0xD0 – 0xDE The actual value depends on the length of the data payload.
Byte 1	length	The length of valid data of payload.
Byte 2 to Byte 63	data	The data payload

The FT260 will send the data from an I²C slave back to the host via the I²C input reports when it receives an I²C read request. As with the write request, the different report IDs define different packet sizes. For input requests, application code may ignore the report ID, but must check the length field to get the valid data size.

4.6 UART

UART (Universal Asynchronous Receiver/Transmitter) is a commonly used interface to transfer serial data. Being asynchronous there is no clock signal but the structure of the transmitted data provides for a start and an end to a message. It is also important that both ends of the link decide to operate with the same pulse width defined as the baud rate. The UART of a micro-controller will normally operate at 3V3 or 5V TTL levels. The UART will only connect to one other device in the chain.

4.6.1 Get UART Settings

Direction: Feature In

Offset	Field	Description
Byte 0	Report ID	0xE0
Byte 1	flow_ctrl	0: OFF, and switch UART pins to GPIO 1: RTS_CTS mode (GPIOB =>RTSN, GPIOE =>CTSN) 2: DTR_DSR mode (GPIOF =>DTRN, GPIOH => DSRN) 3: XON_XOFF (software flow control) 4: No flow control mode
Bytes 2-5	baud_rate	UART baud rate, which is unsigned int, little-endian. e.g.: 9600 = 0x2580 => [0x80, 0x25, 0x00, 0x00] 19200 = 0x4B00 => [0x00, 0x4B, 0x00, 0x00] The FT260 UART supports baud rate range from 1200 to 12M.
Byte 6	data_bit	The number of data bits: 0x07: 7 data bits 0x08: 8 data bits
Byte 7	parity	0: No parity 1: Odd parity. This means that the parity bit is set to either '1' or '0' so that an odd number of 1's are sent 2: Even parity. This means that the parity bit is set to either '1' or '0' so that an even number of 1's are sent 3: High parity. This simply means that the parity bit is always High 4: Low parity. This simply means that the parity bit is always Low
Byte 8	stop_bit	The number of stop bits: 0: one stop bit

		2: two stop bits
Byte 9	breaking	When active the TXD line goes into 'spacing' state which causes a break in the receiving UART. 0: no break 1: break

4.6.2 UART Write Request

Direction: Interrupt Out

Offset	Field	Description
Byte 0	Report ID	0xF0 – 0xFE The actual value determines the maximum size of the data payload, in multiples of 4 bytes. 0xF0 means 4 bytes of data; 0xF1 means 8 bytes, and so on. 0xFE means a maximum of 60 bytes of data.
Byte 1	length	The length of valid data.
Byte 2 to Byte 61	data	The data payload

Maximum Data Payload Size

Because the packet size of a HID report is fixed, the FT260 defines a series of report IDs for sending UART write requests with different packet sizes. For example, the report ID 0xFE defines a 62 bytes packet, which is composed of 2 bytes header and 60 bytes data payload. If the data is larger than 60 bytes, it cannot be sent in one packet. The data must be divided and sent in continuous packets. However, if the data to be sent is just a few bytes, 60 bytes payload seems wasteful. The FT260 defines a series of report IDs with data payload sizes in multiples of 4. Starting from report ID 0xF0, which defines 4 bytes data payload, and the next report ID 0xF1 defines 8 bytes data payload, until report ID 0xFE which defines 60 bytes data payload.

The length field indicates the number of valid bytes in the data payload. For example, if you have 5 bytes to send, you can choose report ID 0xF1, which has 8 bytes payload, and set the length field to 5.

4.6.3 UART Input Report

Direction: Interrupt In

Offset	Field	Description
Byte 0	Report ID	0xF0 – 0xFE The actual value depends on the length of the data payload.
Byte 1	length	The length of valid data
Byte 2 to Byte 63	data	The data payload

The FT260 will send the data from UART RXD back to the host via the UART input reports. As with write requests, the different report IDs define different packet sizes. For input requests, application code may ignore the report ID, but must check the length field to get the valid data size.

4.6.4 Get DCD & RI Status

Direction: Feature In

Offset	Field	Description
Byte 0	Report ID	0xE2
Byte 1	status	Bit0 : status of UART DCD Bit1 : status of UART RI

4.7 GPIO

4.7.1 GPIO Write Request

Direction: Feature Out

Offset	Field	Description
Byte 0	Report ID	0xB0
Byte 1	gpio value	GPIO0–5 values GPIO0: bit[0], GPIO1: bit[1], GPIO2: bit[2], GPIO3: bit[3], GPIO2: bit[4], GPIO3: bit[5]
Byte 2	gpio dir	GPIO0–5 directions: 0b: input 1b: output
Byte 3	gpioEx value	GPIOA–H values GPIOA: bit[0], GPIOB: bit[1], GPIOC: bit[2], GPIOD: bit[3], GPIOE: bit[4], GPIOF: bit[5], GPIOG: bit[6], GPIOH: bit[7]
Byte 4	gpioEx dir	GPIOA–H directions: 0b: input 1b: output

4.7.2 GPIO Read Request

Direction: Feature In

Offset	Field	Description
Byte 0	Report ID	0xB0
Byte 1	gpio value	GPIO0–5 values: GPIO0: bit[0], GPIO1: bit[1], GPIO2: bit[2], GPIO3: bit[3], GPIO2: bit[4], GPIO3: bit[5]
Byte 2	gpio dir	GPIO0–5 directions: 0b: input 1b: output
Byte 3	gpioEx value	GPIOA–H values: GPIOA: bit[0], GPIOB: bit[1], GPIOC: bit[2], GPIOD: bit[3], GPIOE: bit[4], GPIOF: bit[5], GPIOG: bit[6], GPIOH: bit[7]
Byte 4	gpioEx dir	GPIOA–H directions: 0b: input 1b: output

4.8 Interrupt Report

Direction: Interrupt In

Offset	Field	Description
Byte 0	Report ID	0xB1
Byte 1	interrupt	Bit0 : status of interrupt
Byte 2	DCD & RI	Bit0 : status of UART DCD Bit1 : status of UART RI

When the external interrupt, UART DCD, or UART RI happens, the FT260 will send this interrupt report to the host via the UART interrupt in pipe.

5 Sample Code to perform search with libudev

Here is an example which demonstrates how to use libudev to search and find the device path of the FT260.

Example

```
#include <linux/types.h>
#include <linux/input.h>
#include <linux/hidraw.h>
#include <libudev.h>
#include <string.h>

/*
 * For the systems that don't have the new version of hidraw.h in userspace.
 */
#ifndef HIDIOCSFEATURE
#warning Please have your distro update the userspace kernel headers
#define HIDIOCSFEATURE(len)    _IOC(_IOC_WRITE|_IOC_READ, 'H', 0x06, len)
#define HIDIOCGFEATURE(len)    _IOC(_IOC_WRITE|_IOC_READ, 'H', 0x07, len)
#endif

#include <sys/ioctl.h>
#include <sys/types.h>
#include <sys/stat.h>
#include <fcntl.h>
#include <unistd.h>

#include <stdio.h>
#include <string.h>
#include <stdlib.h>
#include <errno.h>

const char* bus_type_str(int bus) {
    switch (bus) {
        case BUS_USB:      return "USB";
        case BUS_HIL:      return "HIL";
        case BUS_BLUETOOTH: return "Bluetooth";
        case BUS_VIRTUAL:  return "Virtual";
        default:           return "Other";
    }
}
```

```
}
```

```
char* get_hid_path(unsigned short vendor_id, unsigned short product_id, unsigned short  
interface_id)
```

```
{
```

```
    struct udev* udev;  
    struct udev_enumerate* enumerate;  
    struct udev_list_entry *devices, *dev_list_entry;  
    struct udev_device* dev;  
    struct udev_device* usb_dev;  
    struct udev_device* intf_dev;  
    char* ret_path = NULL;
```

```
    /* Create the udev object */
```

```
    udev = udev_new();  
    if (!udev)  
    {  
        printf("Can't create udev\n");  
        return NULL;  
    }
```

```
    /* Create a list of the devices in the 'hidraw' subsystem. */
```

```
    enumerate = udev_enumerate_new(udev);  
    udev_enumerate_add_match_subsystem(enumerate, "hidraw");  
    udev_enumerate_scan_devices(enumerate);  
    devices = udev_enumerate_get_list_entry(enumerate);
```

```
    /* udev_list_entry_foreach is a macro which expands to a loop. */
```

```
    udev_list_entry_foreach(dev_list_entry, devices)  
    {  
        const char* path;  
        const char* dev_path;  
        const char* str;  
        unsigned short cur_vid;  
        unsigned short cur_pid;  
        unsigned short cur_interface_id;  
  
        path = udev_list_entry_get_name(dev_list_entry);  
        dev = udev_device_new_from_syspath(udev, path);
```

```
dev_path = udev_device_get_devnode(dev);

/* Find the next parent device, with matching
   subsystem "usb" and devtype value "usb_device" */
usb_dev = udev_device_get_parent_with_subsystem_devtype(
    dev, "usb", "usb_device");
if (!usb_dev)
{
    printf("Unable to find parent usb device.");
    return NULL;
}

str = udev_device_get_sysattr_value(usb_dev, "idVendor");
cur_vid = (str)? strtol(str, NULL, 16): -1;
str = udev_device_get_sysattr_value(usb_dev, "idProduct");
cur_pid = (str)? strtol(str, NULL, 16): -1;

intf_dev = udev_device_get_parent_with_subsystem_devtype(
    dev, "usb", "usb_interface");
if (!intf_dev)
{
    printf("Unable to find parent usb interface.");
    return NULL;
}

str = udev_device_get_sysattr_value(intf_dev, "bInterfaceNumber");
cur_interface_id = (str)? strtol(str, NULL, 16): -1;

printf("vid=%x pid=%x interface=%d\n", cur_vid, cur_pid, cur_interface_id);

if(cur_vid == vendor_id
    && cur_pid == product_id
    && cur_interface_id == interface_id)
{
    ret_path = strdup(dev_path);
    udev_device_unref(dev);
    break;
}
```

```
    udev_device_unref(dev);
}

/* Free the enumerator object */
udev_enumerate_unref(enumerate);
udev_unref(udev);

return ret_path;
}

int main(int argc, char** argv)
{
    int fd;
    int res, desc_size = 0;
    char buf[256];
    struct hidraw_report_descriptor rpt_desc;
    struct hidraw_devinfo info;
    char* device_path = NULL;

    if (argc > 1)
    {
        device_path = malloc(100);
        strcpy(device_path, argv[1]);
    }
    else
    {
        /* remember to free device_path */
        device_path = get_hid_path(0x0403, 0x6030, 0);
    }

    if(!device_path)
    {
        perror("Can not find the device path");
        return 1;
    }

    /* Open the Device with non-blocking reads. */
    fd = open(device, O_RDWR|O_NONBLOCK);
```



```
if (fd < 0) {
    perror("Unable to open device");
    return 1;
}

memset(&rpt_desc, 0x0, sizeof(rpt_desc));
memset(&info, 0x0, sizeof(info));
memset(buf, 0x0, sizeof(buf));

/* Get Report Descriptor Size */
res = ioctl(fd, HIDIOCGRDESCSIZE, &desc_size);
if (res < 0) {
    perror("HIDIOCGRDESCSIZE");
} else {
    printf("Report Descriptor Size: %d\n", desc_size);
}

/* Get Raw Name */
res = ioctl(fd, HIDIOCGRAWNAME(256), buf);
if (res < 0) {
    perror("HIDIOCGRAWNAME");
} else {
    printf("Raw Name: %s\n", buf);
}

/* Get Raw Info */
res = ioctl(fd, HIDIOCGRAWINFO, &info);
if (res < 0) {
    perror("HIDIOCGRAWINFO");
} else {
    printf("Raw Info:\n");
    printf("\tbustype: %d (%s)\n",
           info.bustype, bus_type_str(info.bustype));
    printf("\tvendor: 0x%04hx\n", info.vendor);
    printf("\tproduct: 0x%04hx\n", info.product);
}

/* Set Feature */
buf[0] = 0xA1; /* SYSTEM_SETTING_ID */
```

```
buf[1] = 0x22; /* I2C_SPEED */
buf[2] = 0x01; /* 400Kbps */
buf[3] = 0x90;
res = ioctl(fd, HIDIOCSFEATURE(4), buf);
if (res < 0) {
    perror("HIDIOCSFEATURE");
} else {
    printf("ioctl HIDIOCGFEATURE returned: %d\n", res);
}

/* Send a Report to the Device */
buf[0] = 0xD0; /* I2C write */
buf[1] = 0x22; /* Slave address */
buf[2] = 0x06; /* Start and Stop */
buf[3] = 0x03; /* data len */
buf[4] = 'a';
buf[5] = 'b';
buf[6] = 'c';

res = write(fd, buf, 7);
if (res < 0) {
    printf("Error: %d\n", errno);
    perror("write");
} else {
    printf("write() wrote %d bytes\n", res);
}

free(device_path);
close(fd);
return 0;
}
```

6 Contact Information

Head Office – Glasgow, UK

Future Technology Devices International Limited
Unit 1, 2 Seaward Place, Centurion Business Park
Glasgow G41 1HH
United Kingdom
Tel: +44 (0) 141 429 2777
Fax: +44 (0) 141 429 2758

E-mail (Sales) sales1@ftdichip.com
E-mail (Support) support1@ftdichip.com
E-mail (General Enquiries) admin1@ftdichip.com

Branch Office – Taipei, Taiwan

Future Technology Devices International Limited
(Taiwan)
2F, No. 516, Sec. 1, NeiHu Road
Taipei 114
Taiwan, R.O.C.
Tel: +886 (0) 2 8791 3570
Fax: +886 (0) 2 8791 3576

E-mail (Sales) tw.sales1@ftdichip.com
E-mail (Support) tw.support1@ftdichip.com
E-mail (General Enquiries) tw.admin1@ftdichip.com

Branch Office – Tigard, Oregon, USA

Future Technology Devices International Limited
(USA)
7130 SW Fir Loop
Tigard, OR 97223-8160
USA
Tel: +1 (503) 547 0988
Fax: +1 (503) 547 0987

E-Mail (Sales) us.sales@ftdichip.com
E-Mail (Support) us.support@ftdichip.com
E-Mail (General Enquiries) us.admin@ftdichip.com

Branch Office – Shanghai, China

Future Technology Devices International Limited
(China)
Room 1103, No. 666 West Huaihai Road,
Shanghai, 200052
China
Tel: +86 21 62351596
Fax: +86 21 62351595

E-mail (Sales) cn.sales@ftdichip.com
E-mail (Support) cn.support@ftdichip.com
E-mail (General Enquiries) cn.admin@ftdichip.com

Web Site

<http://ftdichip.com>

Distributor and Sales Representatives

Please visit the Sales Network page of the [FTDI Web site](#) for the contact details of our distributor(s) and sales representative(s) in your country.

System and equipment manufacturers and designers are responsible to ensure that their systems, and any Future Technology Devices International Ltd (FTDI) devices incorporated in their systems, meet all applicable safety, regulatory and system-level performance requirements. All application-related information in this document (including application descriptions, suggested FTDI devices and other materials) is provided for reference only. While FTDI has taken care to assure it is accurate, this information is subject to customer confirmation, and FTDI disclaims all liability for system designs and for any applications assistance provided by FTDI. Use of FTDI devices in life support and/or safety applications is entirely at the user's risk, and the user agrees to defend, indemnify and hold harmless FTDI from any and all damages, claims, suits or expense resulting from such use. This document is subject to change without notice. No freedom to use patents or other intellectual property rights is implied by the publication of this document. Neither the whole nor any part of the information contained in, or the product described in this document, may be adapted or reproduced in any material or electronic form without the prior written consent of the copyright holder. Future Technology Devices International Ltd, Unit 1, 2 Seaward Place, Centurion Business Park, Glasgow G41 1HH, United Kingdom. Scotland Registered Company Number: SC136640

Appendix A – References

Document References

[DS_FT260](#)

Acronyms and Abbreviations

Terms	Description
GPIO	General-purpose input/output
HID	Human Interface Device
I2C	Inter-Integrated Circuit
UART	Universal Asynchronous Receiver/Transmitter
USB	Universal Serial Bus
USB-IF	USB Implementers Forum

Appendix B – List of Tables & Figures

List of Tables

Table 1.1 FT260 interface configuration	6
Table 1.2 FT260 endpoints	6
Table 4.1 Baud Rate Comparison	20

List of Figures

Figure 1.1 The FT260 System Block Diagram	5
Figure 2.1 The FT260 connects with I ² C bus	7
Figure 2.2 The FT260 connects to an UART device.....	7

Appendix C – Revision History

Document Title: AN_394 User Guide for FT260
Document Reference No.: FT_001279
Clearance No.: FTDI# 488
Product Page: <http://www.ftdichip.com/FTProducts.htm>
Document Feedback: [Send Feedback](#)

Revision	Changes	Date
1.0	Initial Release	2016-03-08
1.1	Added section 4.4.4 I2C mode configure Updated section 4.4.2 Get system status table list	2018-09-03