

High Temperature Silicon Carbide Power Schottky Diode

V_{RRM}	=	650 V
V_F	=	1.7 V
I_F	=	5 A
Q_C	=	20 nC

Features

- 650 V Schottky rectifier
- 250 °C maximum operating temperature
- Zero reverse recovery charge
- Superior surge current capability
- Positive temperature coefficient of V_F
- Temperature independent switching behavior
- Lowest figure of merit Q_C/I_F
- Available screened to Mil-PRF-19500

Package

- RoHS Compliant

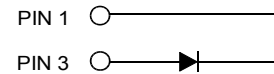
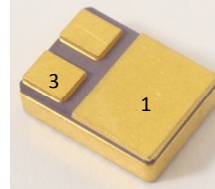

Advantages

- High temperature operation
- Improved circuit efficiency (Lower overall cost)
- Low switching losses
- Ease of paralleling devices without thermal runaway
- Smaller heat sink requirements
- Industry's lowest reverse recovery charge
- Industry's lowest device capacitance
- Ideal for output switching of power supplies
- Best in class reverse leakage current at operating temperature

Applications

- Down Hole Oil Drilling, Geothermal Instrumentation
- High Temperature DC/DC Converters
- High Temperature Motor and Servo Drives
- High Temperature Inverters
- High Temperature Actuator Control
- Military Power Supplies
- Ideal for Aerospace and Defense Applications

Maximum Ratings at $T_j = 250\text{ °C}$, unless otherwise specified

Parameter	Symbol	Conditions	Values	Unit
Repetitive peak reverse voltage	V_{RRM}		650	V
Continuous forward current	I_F	$T_C \leq 225\text{ °C}$	4.3	A
RMS forward current	$I_{F(RMS)}$	$T_C \leq 225\text{ °C}$	8	A
Surge non-repetitive forward current, Half Sine Wave	$I_{F,SM}$	$T_C = 25\text{ °C}$, $t_p = 10\text{ ms}$	32	A
Non-repetitive peak forward current	$I_{F,max}$	$T_C = 25\text{ °C}$, $t_p = 10\text{ }\mu\text{s}$	120	A
I^2t value	$\int i^2 dt$	$T_C = 25\text{ °C}$, $t_p = 10\text{ ms}$	5	A ² S
Power dissipation	P_{tot}	$T_C = 25\text{ °C}$	163	W
Operating and storage temperature	T_j, T_{slg}		-55 to 250	°C

Electrical Characteristics at $T_j = 250\text{ °C}$, unless otherwise specified

Parameter	Symbol	Conditions	Values			Unit
			min.	typ.	max.	
Diode forward voltage	V_F	$I_F = 5\text{ A}$, $T_j = 25\text{ °C}$		1.65		V
		$I_F = 5\text{ A}$, $T_j = 210\text{ °C}$		2.5		
Reverse current	I_R	$V_R = 650\text{ V}$, $T_j = 25\text{ °C}$		0.12	5	μA
		$V_R = 650\text{ V}$, $T_j = 250\text{ °C}$		7.5	30	
Total capacitive charge	Q_C	$I_F \leq I_{F,MAX}$ $dI_F/dt = 200\text{ A}/\mu\text{s}$ $T_j = 210\text{ °C}$		20		nC
Switching time	t_s	$V_R = 400\text{ V}$ $V_R = 400\text{ V}$		< 25		ns
Total capacitance	C	$V_R = 1\text{ V}$, $f = 1\text{ MHz}$, $T_j = 25\text{ °C}$		274		pF
		$V_R = 400\text{ V}$, $f = 1\text{ MHz}$, $T_j = 25\text{ °C}$		31		
		$V_R = 800\text{ V}$, $f = 1\text{ MHz}$, $T_j = 25\text{ °C}$		29		

Thermal Characteristics

Thermal resistance, junction - case	R_{thJC}	1.38	°C/W
-------------------------------------	------------	------	------

Mechanical Properties

Mounting torque	M	0.6	Nm
-----------------	---	-----	----

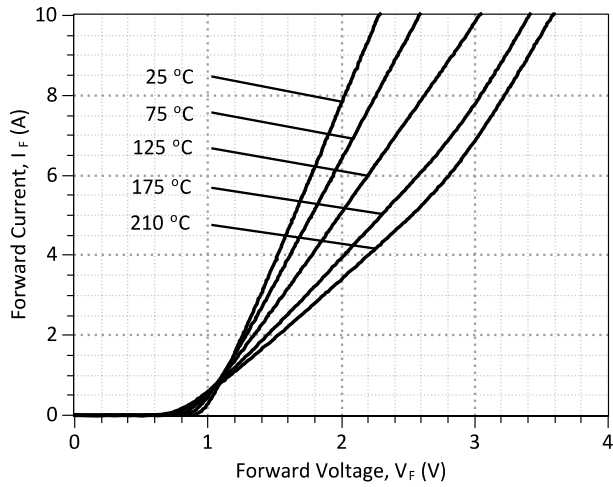

Figure 1: Typical Forward Characteristics

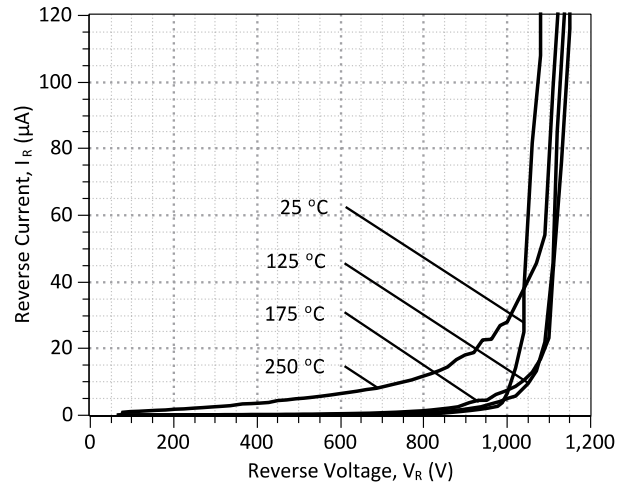

Figure 2: Typical Reverse Characteristics

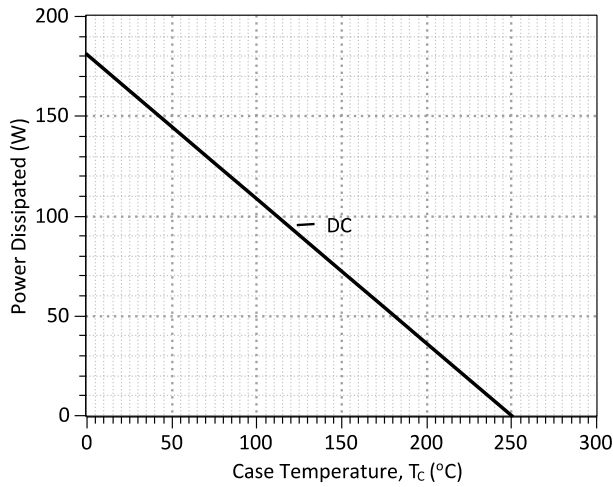
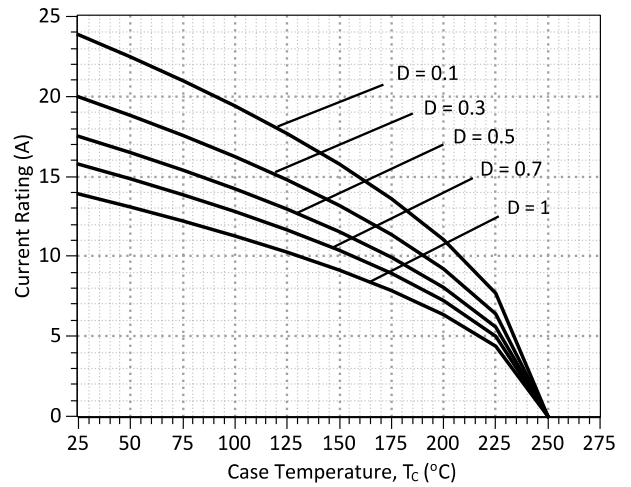

Figure 3: Power Derating Curve



**Figure 4: Current Derating Curves ($D = t_p/T$, $t_p = 400 \mu s$)
(Considering worst case Z_{th} conditions)**

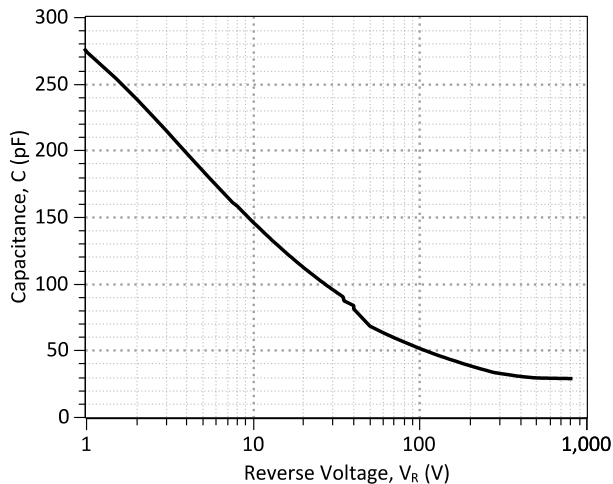

Figure 5: Typical Junction Capacitance vs Reverse Voltage Characteristics

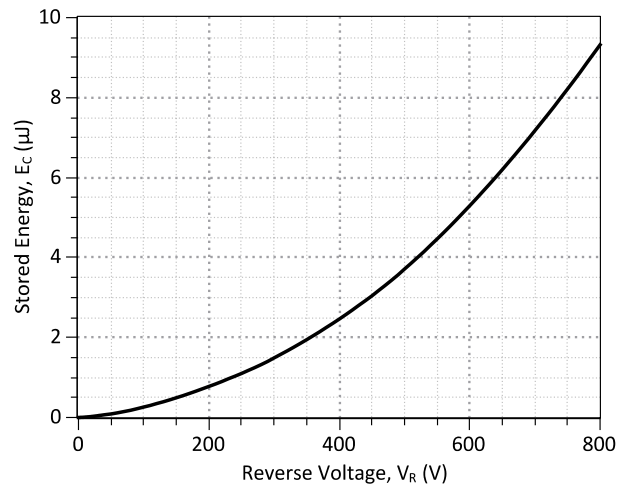

Figure 6: Typical Switching Energy vs Reverse Voltage Characteristics

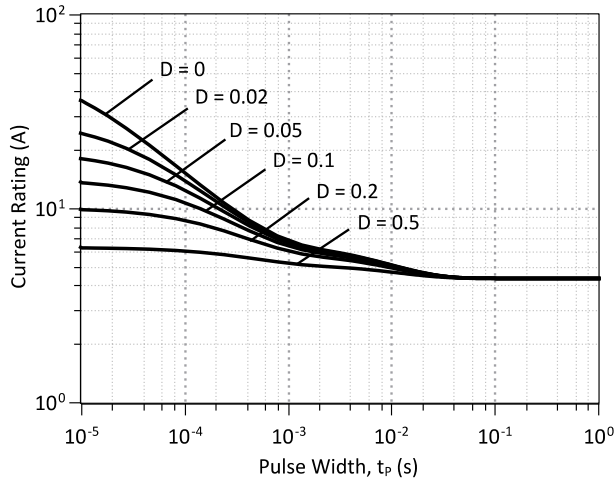

Figure 7: Current vs Pulse Duration Curves at $T_c = 225\text{ }^\circ\text{C}$

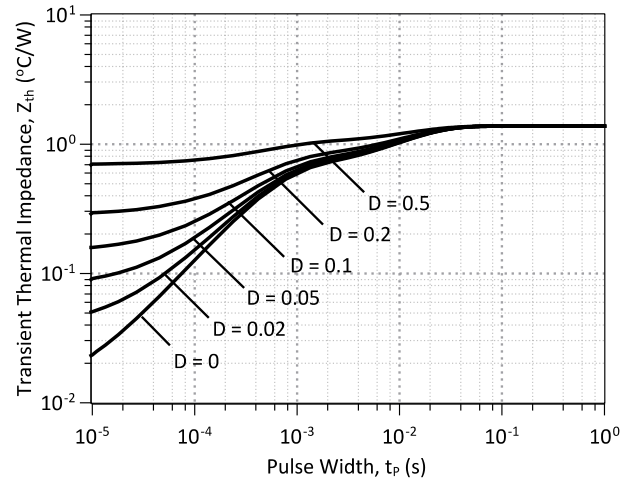
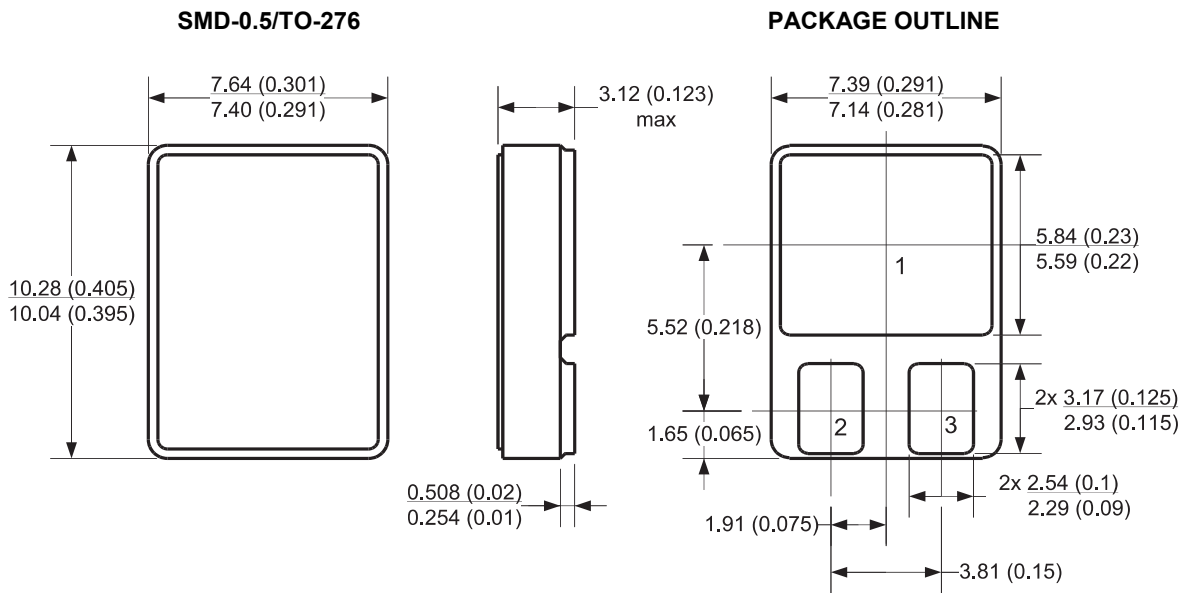

Figure 8: Transient Thermal Impedance

Package Dimensions:



NOTE

1. CONTROLLED DIMENSION IS INCH. DIMENSION IN BRACKET IS MILLIMETER.
2. DIMENSIONS DO NOT INCLUDE END FLASH, MOLD FLASH, MATERIAL PROTRUSIONS

Revision History

Date	Revision	Comments	Supersedes
2012/04/24	0	Initial release	

Published by

GeneSiC Semiconductor, Inc.
43670 Trade Center Place Suite 155
Dulles, VA 20166

GeneSiC Semiconductor, Inc. reserves right to make changes to the product specifications and data in this document without notice.

GeneSiC disclaims all and any warranty and liability arising out of use or application of any product. No license, express or implied to any intellectual property rights is granted by this document.

Unless otherwise expressly indicated, GeneSiC products are not designed, tested or authorized for use in life-saving, medical, aircraft navigation, communication, air traffic control and weapons systems, nor in applications where their failure may result in death, personal injury and/or property damage.