

PREPARED BY : DATE	 LCD GROUP SHARP CORPORATION SPECIFICATION	SPEC No. LCP-2110015A
APPROVED BY : DATE		FILE No.
		ISSUE : June. 21. 2010
PAGE : 28 pages APPLICABLE GROUP LIQUID CRYSTAL DISPLAY GROUP		

DEVICE SPECIFICATION FOR

LCD Module

MODEL No. **LS027B7DH01**

CUSTOMER'S APPROVAL

DATE _____

BY _____

TRAIL TECH INC.

PRESENTED

BY F. Kinoshita

F. KINOSHITA
 GENERAL MANAGER
 ENGINEERING DEPT1.
 LCD DIVISION 2
 LCD GROUP
 SHARP CORPORATION

NOTICE**<<Precautions>>**

- These specification sheets are the proprietary product of SHARP CORPORATION ("SHARP") and include materials protected under copyright of SHARP. Do not reproduce or cause any third party to reproduce them in any form or by any means, electronic or mechanical, for any purpose, in whole or in part, without the express written permission of SHARP.
- The application examples in these specification sheets are provided to explain the representative applications of the device and are not intended to guarantee any industrial property right or other rights or license you to use them. SHARP assumes no responsibility for any problems related to any industrial property right of a third party resulting from the use of the device.
- SHARP reserves the right to make changes in the specifications, characteristics, data, materials, structures and other contents described herein at any time without notice in order to improve design or reliability. Contact SHARP in order to obtain the latest specification sheets before using any SHARP's device. Manufacturing locations are also subject to change without notice.

Observe the following points when in using any device in this publication. SHARP takes no responsibility for damage caused by improper use of the devices.

The devices in this publication are designed for use in general electronic equipment designs, such as:

- Personal computers
- Office automation
- Telecommunication equipment
- Test and measurement equipment
- Industrial control
- Audio visual and multimedia equipment
- Consumer electronics

The appropriate design measures should be taken to ensure reliability and safety when SHARP's devices are used for equipment such as:

- Transportation control and safety equipment(i.e.,aircraft,trains,automobiles,etc.)
- Traffic signals
- Gas leakage sensor breakers
- Alarm equipment
- Various safety devices etc.

○ SHARP's devices shall not be used for equipment that requires extremely high level of reliability, such as:

- Military and space applications
- Nuclear power control equipment
- Medical equipment for life support

○ SHARP assumes no responsibility for any damage resulting from the use of the device which does not comply with the instructions and the precautions specified in these specification sheets.

○ Contact and consult with a SHARP sales representative for any questions about this device.

[For handling and system design]

(1) Handle with care as glass is used in this LCD panel. Dropping or contact against hard object may cause cracks or chips.

(2) Be careful to handle this LCD panel in order to avoid injury yourself by panel's edge as this panel is made of glass and might be a sharp edge.

(3) Do not scratch the surface of the polarizer film as it is easily damaged.

(4) Water droplets on the polarizer film must be wiped off immediately as they may cause color changes, or other defects if remained for a long time.

(5) Do not leave the LCD panel in direct sun or under ultraviolet ray.

(6) To clean LCD panel surface, wipe clean with absorbent cotton or soft cloth. If further cleaning is needed, use IPA (isopropyl alcohol) and wipe clean lightly on surface only. Do not use organic solvents as it may damage the LCD panel terminal area which uses organic material. Also, do not directly touch with finger. When the terminals cleaning are needed, those should be wiped by a soft cloth or a cotton swab without directly touching by hand.

(7) Do not expose gate driver, etc. on the panel (circuit area outside panel display area) to light as it may not operate properly. Design that shields gate driver, etc. from light is required when mounting the LCD module.

(8) To avoid circuit failure, do not touch panel terminal area.

(9) Support for the LCD panel should be carefully designed to avoid stress that exceeds specification on glass surface.

(10) When handling LCD module and assembling them into cabinets, be noted that storage in the environment of oxidization or deoxidization gas and the use of such materials as reagent, solvent, adhesive, resin, and etc. which generate these gasses, may cause corrosion and discoloration of LCD modules.

(11) To avoid picture uniformity failure, do not put a seal or an adhesive material on the panel surface.

(12) Do not use chloroprene rubber as it generates chlorine gas and affects reliability in LCD panel connective area.

(13) Protective film is attached to both of surface polarizer films (front polarizer and rear polarizer) on LCD panel to prevent scratches or other damages. Remove these protective films before use. In addition, do not attach the protective films which are removed from LCD module again. When the LCD panel which has the reattached protective film is needed to storage for a long time, the polarizer film might have a damage with picture quality failure.

(14) Panel is susceptible to mechanical stress and such stress may affect the display. Place the panel on flat surface to avoid stress caused by twist, bend, etc.

(15) When transporting LCD panels, secure them in LCD panel tray to avoid mechanical stress. The tray should be conductive to protect LCD panels from static charge.

Material used in set or epoxy resin (amine type hardening agent) from packaging, and silicon adhesive (dealcoholized or oxime) all release gas which may affect quality of polarizer film. Do confirm compatibility with user materials.

(16) As this LCD module is composed electronic circuits, it is sensitive to electrostatic discharge of 200V or more.

Handle with care using cautions for the followings:

- Operators

Operators must wear anti-static wears to prevent electrostatic charge up to and discharge from human body.

- Equipment and containers

Process equipment such as conveyer, soldering iron, working bench and containers may possibly generate electrostatic charge up and discharge. Equipment must be grounded through 100Mohms resistance. Use ion blower.

- Floor

Floor plays an important role in leaking static electricity generated in human body or equipment. If the floor is made of insulated material (such as polymer or rubber material), such static electricity may charge. Proper measure should be taken to avoid static electricity charge (electrostatic earth: 100Mohms). There is a possibility that the static electricity is charged to them without leakage in case of insulating floor, so the electrostatic earth: $1 \times 10^8 \Omega$ should be made.

- Humidity

Humidity in work area relates to surface resistance of the persons or objects that generate electrostatics, and it can be manipulated to prevent electrostatic charge. Humidity of 40% or lower increases electrostatic earth resistance and promotes electrostatic charging. Therefore, the humidity in the work area should be kept above 40%. Specifically for film peeling process or processes that require human hands, humidity should be kept above 50% and use electricity removal blower.

- Transportation/Storage

Containers and styroform used in transportation and storage may charge electrostatic (from friction and peeling) or electrostatic charge from human body, etc. may cause containers and styroform to have induced charge. Proper electrostatic measure should be taken for containers and storage material.

[For operating LCD module]

- (1) Do not operate the LCD panel under outside of electrical specification. Otherwise LCD panel may be damaged.
- (2) Do not use the LCD panel under outside of specified driving timing chart. Otherwise LCD panel may not have proper picture quality.
- (3) A still image should be displayed less than two hours, if it is necessary to display still image longer than two hour, display image data must be refreshed in order to avoid sticking image on LCD panel.
- (4) If LCD module takes a static electricity, as the display image which is written into pixel memory might not be displayed, Data update should be executed frequently.
- (5) It is neither a breakdown nor a defective indication though very slight change in black level might be periodically seen in a black part on the black display image according to the source of light (angle of the luminance and the source of light).

[Precautions for Storage]

- (1) After opening the package, do not leave the LCD panel in direct sun or under strong ultraviolet ray. Store in dark place.
- (2) In temperature lower than specified rating, liquid crystal material will coagulate. In temperature higher than specified rating, it isotropically liquifies. In either condition, the liquid crystal may not recover its original condition. Store the LCD panel in at or around room temperature as much as possible.
Also, storing the LCD panel in high humidity will damage the polarizer. Store in normal room temperature as much as possible.

(3) Keeping Method

- a. No direct sun light
- b. Store in trays and in dark room

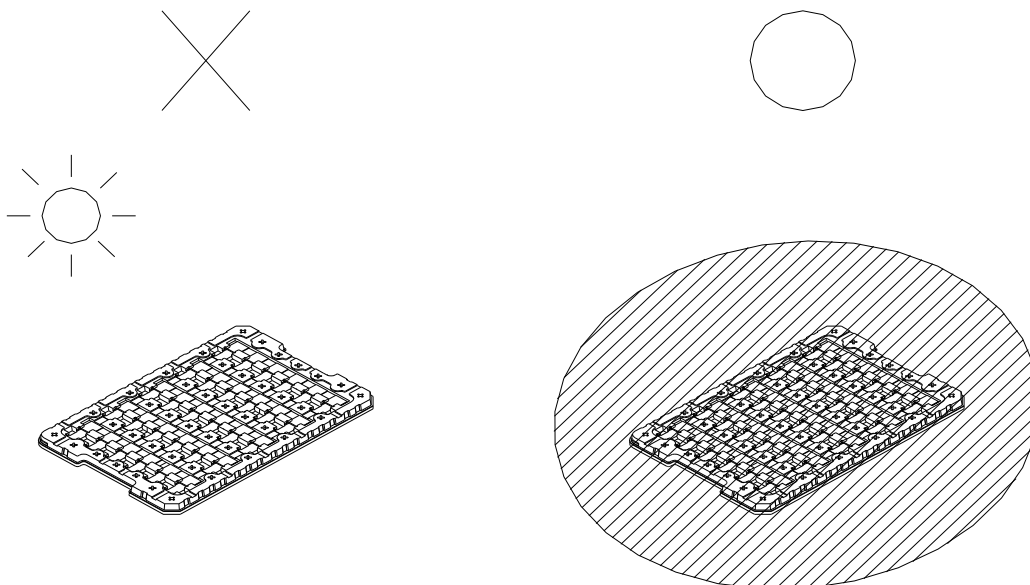

[Other Notice]

- (1) Operation outside specified environmental conditions cannot be guaranteed.
- (2) As power supply (VDD-GND、VDDA-GND) impedance is lowered during use, bus controller should be inserted near LCD module as much as possible.
- (3) Polarizer film is applied over LCD panel surface. Liquid crystal inside LCD panel deteriorates with ultraviolet ray. The panel should not be left in direct sun or under strong ultraviolet ray for prolonged period of time even with the polarizer film.
- (4) Disassembling the LCD module will cause permanent damage to the module. Do not disassemble the module.
- (5) If LCD panel is broken, do not ingest the liquid crystal from the broken panel. If hand, leg, or clothes come in contact with liquid crystal, wash off immediately with soap.
- (6) ODS (specific chlorofluorocarbon, specific halon, 1-1-1 trichloroethane, carbon tetrachloride) are not used or contained in material or all production processes of this product.
- (7) Observe all other precautionary requirements in handling general electronic components.

Discarding liquid crystal modules

LCD Panel : Dispose of as glass waste. This LCD module contains no harmful substances.

The liquid crystal panel contains no dangerous or harmful substances.

This liquid crystal panel contains only an extremely small amount of liquid crystal (approximately 100mg) and therefore it will not leak even if the panel should break.

Its median lethal dose (LD50) is greater than 2,000 mg/kg and a mutagenetic (Aims test: negative) material is used.

FPC : (1) FPC bend R should be 0.45mm or greater and R should be even.

In LCD panel an connective area, do not bend FPC into polarizer film side.

(2) Do not hang LCD module by FPC or apply force to FPC.

Index

1. Scope of Application	7
2. Overview	7
3. Mechanical Specification	7
4. Input Terminal names and function	8
5. Absolute Maximum Rating	9
6. Electrical Characteristics	10
7. Optical Characteristics	21
8. Outline Dimension	23
9. External Circuit Example	24
10. External Power Supply Circuit	25
11. Packaging	26
12. Reliability Test Conditions	28

1. Scope of Application

Reflective active-matrix with slightly transmissive type memory liquid crystal display module with WQVGA (400x240) panel which uses CG silicon thin film transistor.

2. Overview

- 2.7" WQVGA monochrome HR-TFT transfective panel
- Transmissive mode is available by implementation with backlight. (Transmission ratio is around 0.25%)
- 400x240 dot stripe arrangement
- Display control with serial data signal communication
- Arbitrary gate line is selectable to data update
- Internal 1bit memory within the panel for data memory
- Thin, light and compact module with monolithic technology
- Super low power consumption TFT panel
- With FPC (Applicable connector: Refer to recommended connector on page 21.)

3. Mechanical Specification

Table 3-1 Module Mechanical Specification

Item	Specification	Unit
Screen Size (Diagonal)	6.86cm (2.7")	cm
Viewing Area	58.8 (H) × 35.28 (V)	mm
Dot Structure	400 (H) × 240 (V)	dot
Dot pitch	0.147 (H) × 0.147 (V)	mm
Pixel Arrangement	Stripe arrangement	-
Module outline dimension (Extruded part not included)	62.8 (W) × 42.82 (H) × 1.64 (D)	mm
Weight (typ)	9.9	g
Surface Hardness	3H or more (Initial)	Pencil hardness

(Remark) Refer to Figure 8-1 for detailed dimension and tolerance.

4. Input Terminal names and function

4-1) Input Terminal

Table 4-1

Terminal	Code	I/O	Function	Remark
1	SCLK	INPUT	Serial clock signal	
2	SI	INPUT	Serial input signal	
3	SCS	INPUT	Chip select signal	
4	EXTCOMIN	INPUT	External COM inversion signal input (H: Active)	
5	DISP	INPUT	Display ON/OFF signal	【Remark 4-2】
6	VDDA	POWER	Analog power supply	
7	VDD	POWER	Digital power supply	
8	EXTMODE	INPUT	COM inversion mode switch terminal	【Remark 4-1】
9	VSS	POWER	Logic GND	
10	VSSA	POWER	Analog GND	

【Remark 4-1】 “H”=EXTCOMIN signal enabled, “L”=Serial input flag enabled.

When “H”, connect EXTMODE to VDD and when “L” to VSS.

【Remark 4-2】 ON/OFF for LCD display only. Memory data is maintained.

When “H”, displays with memory data, and when “L”, displays all white with memory data maintained.

4-2) Recommended Circuit

COM signal serial input
EXTMODE="L"

External COM signal input
EXTMODE="H"

COM Signal Serial Input
EXTMODE=L

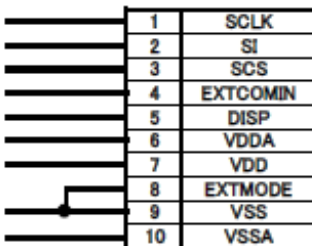

External COM Signal Input
EXTMODE=H

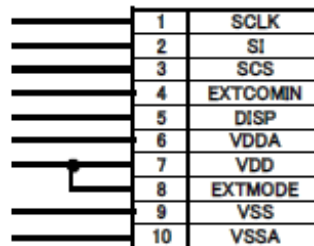

5. Absolute Maximum Rating

Table 5-1 (GND=0V)

Item		Code	MIN.	MAX.	Unit	Remark
Power supply Voltage	Analog Power Supply	VDDA	-0.3	+5.8	V	
	Logic Power Supply	VDD	-0.3	+5.8	V	【Remark 5-1】
Input signal terminal voltage (high)				VDD	V	【Remark 5-2】
Input signal terminal voltage (low)			-0.3		V	
Storage temperature		Tstg	-30	+80	°C	【Remark 5-3,4】
Operating temperature (Panel surface temperature)		Topr1	-20	+70	°C	【Remark 5-5】

【Remark 5-1】 Also applicable to EXTMODE.

【Remark 5-2】 Applicable to SCLK, SI, SCS, DISP, EXTCOMIN.

【Remark 5-3】 Do not exceed this rating in any area of the module.

【Remark 5-4】 Maximum wet-bulb temperature should be 57°C or lower. Do not allow condensation.

Condensation may cause electrical leak and the module may not meet s specification.

【Remark 5-5】 Operating temperature is temperature that guarantess operation only. For contrast, response speed, and other display quty, module is evaluated at Ta=+25°C.

6. Electrical Characteristics

6-1) TFT LCD Panel Driving Part

Table 7-1 Recommended Operating Condition

VSS(GND)=0V, Ta= +25°C

Item		Code	MIN.	TYP.	MAX.	Unit	Remark
Power supply voltage	Analog power Supply	VDDA	+4.8	+5.0	+5.5	V	
	Logi power supply	VDD	+4.8	+5.0	+5.5	V	【Remark 6-1】
Input singal voltage	Hi	VIH	+2.70	+3.00	※VDD	V	【Remark 6-2】
	Lo	VIL	VSS	VSS	VSS+0.15	V	

※Can operate below VDD voltage, however, operation around 3V is recommended.

【Remark 6-1】 Also applicable to EXTMODE="H".

【Remark 6-2】 Applies to SCLK, SI, SCS, DISP, EXTCOMIN.

6-2) Power Supply Sequence

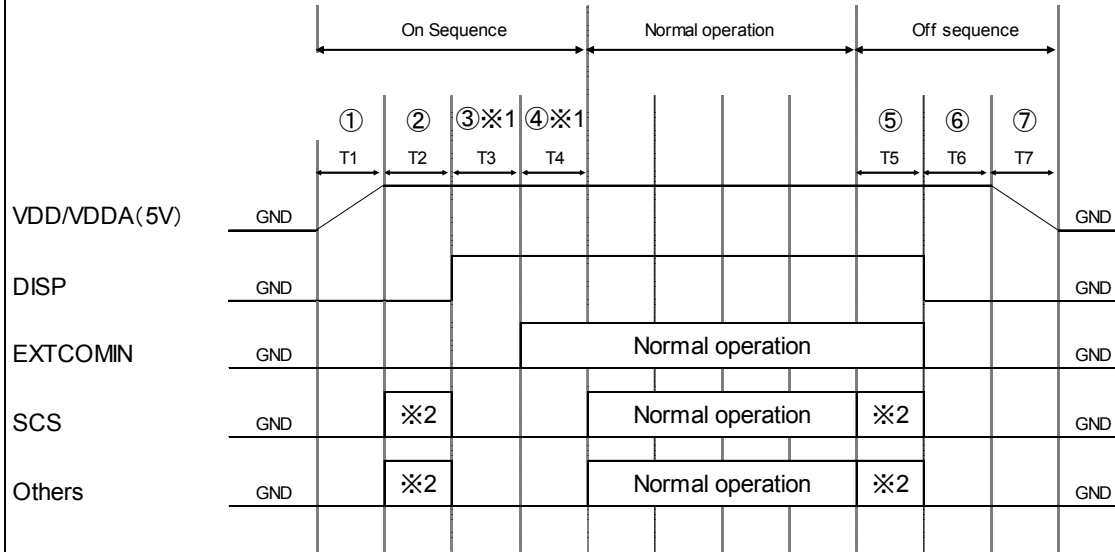

※Refer to timing chart and AC timing characteristics for detail

※1 ③ and ④ may be opposite (however, TCOM polarity inversion will not occur even with EXTCOMIN between DISP="L". Also, when DISP and EXTCOMIN are simultaneously started up, allow 30us or more before SCS starts up (It may be less than 60us).

※2 Setting value for pixel memory initialization

SCS=Driving accordingly to clear pixel internal memory method (use all clear flag or write all screen white)

S1=M2 (all clear flag) = "H" or write white

SCLK: Normal Driving

[ON Sequence]

(1) 5V rise time (depends on IC)

(2) Pixel memory initialization T2: 1V or more Initialize with M2 (all clear flag) or write all screen white

(3) Release time for initialization of TCOM latch T3: 30us or more

Time required to release COM related latch circuit initialization which is initializing using DISP signals

(4) TCOM polarity initialization time T4: 30us or more

Time required initializing TCOM polarity accordingly to EXTCOMIN input

[Normal Operation]

Duration of normal driving

[Off Sequence]

(5) Pixel memory initialization time T5: 1V or more

(6) VA, VB, VCOM initialization time T6: 1V or more

(7) 5V falling time (Depends on IC)

【Remark】 Cautions when powering on

Remark 1) VDD and VDDA should rise simultaneously or VDD should rise first.

Remark 2) VDD and VDDA should fall simultaneously or VDD should fall first

6-3) Input Signal Basic Characteristics

Table 6-3-1

VDDA=+5.0V, VDD=+5.0V, GND=0V, Ta=25°C

Item	Code	MIN	TYP	MAX	Unit	Remark
Frame Frequency	fSCS	1	-	20	Hz	
Clock Frequency	fSCLK		1	2	MHz	
Vertical rush duration	tV	49.993	-	1000	ms	
COM Frequency	fCOM	0.5	-	10	Hz	

Table 6-3-2

VDDA=+5.0V, VDD=+5.0V, GND=0V, Ta=25°C

Item	Code	MIN	TYP	MAX	Unit	Remark
SCS rising time	trSCS			50	ns	
SCS falling time	tfSCS			50	ns	
SCS High width	twSCSH	220			us	Data update mode
		12			us	Display mode
SCS Low width	twSCLSL	1			us	
SCS setup time	tsSCS	3			us	
SCS hold time	thSCS	1			us	
SI rising time	trSI			50	ns	
SI falling time	tfSI			50	ns	
SI set up time	tsSI	120			ns	
SI hold time	thSI	190			ns	
SCLK rising time	trSCLK			50	ns	
SCLK falling time	tfSCLK			50	ns	
SCLK High width	twSCLKH	200	450		ns	
SCLK Low width	twSCLKL	200	450		ns	
EXTCOMIN signal frequency	fEXTCOMIN		1	20	Hz	【Remark 6-3】
EXTCOMIN signal rising time	trEXTCOMIN			50	ns	
EXTCOMIN signal falling time	tfEXTCOMIN			50	ns	
EXTCOMIN signal High width	twEXTCOMIN	1			us	
DISPrising time	trDISP			50	ns	
DISP falling time	tfDISP			50	ns	

【Remark 6-3】 EXTCOMIN frequency should be made lower than frame frequency.

SCS, SI, SCLK signal

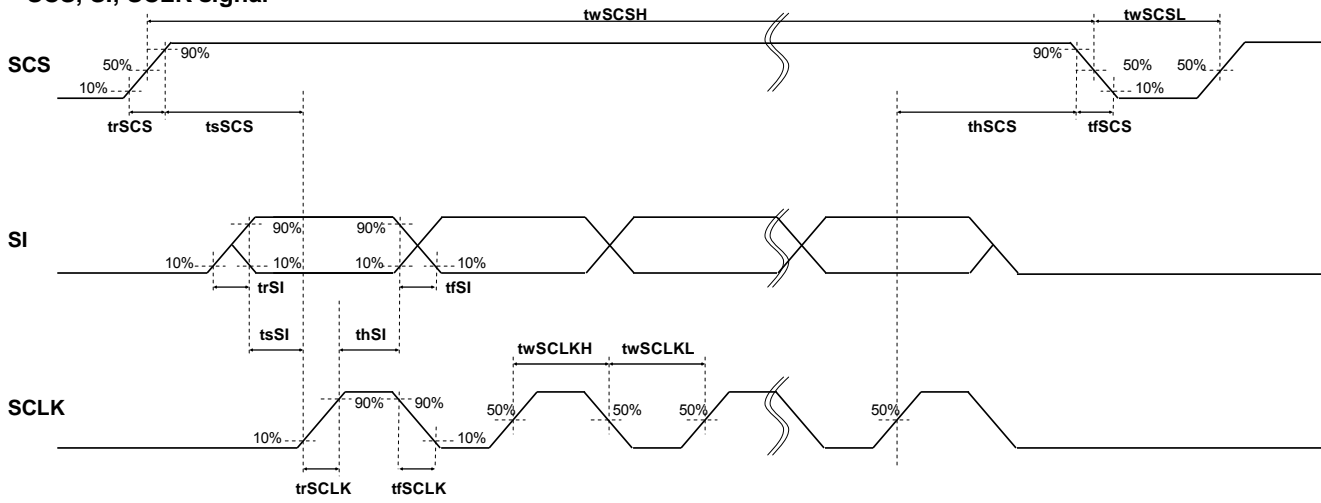

EXTCOMIN signal

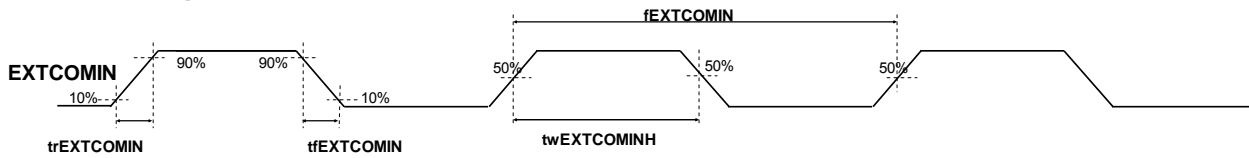

DISP signal

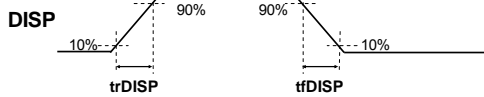

* SCS,SI,SCLK, DISP, EXTCOMIN: 3V input voltage

6-4) Power Consumption (Average)

Table 6-4

Ta=25°C

Item	Min	TYP	MAX	Unite	Remark
Measurement Condition 1	-	50	250	uW	【Remark 6-4】
Measurement Condition 2	-	175	350	uW	【Remark 6-4】

*Measurement Condition 1

Display mode (no display data update), Display pattern: Vertical stripe display

*Measurement Condition 2

Data update mode (with display data update: 1Hz)

Common inversion with VDD=5V、VDDA=5V、fSCLK=1MHz、fSCS=1Hz, Display pattern: Vertical stripe display

【Remark 6-4】 This is value in steady condition, not the value of peak power at the time of COM operation.
Some margining for power supply is recommended. We recommend capacitor for VDD and VDDA.
(If VDD and VDDA are on separate systems, we recommend capacitor for each.)

6-5) Input Signal Timing Chart

6-5-1 Data update mode (1 line)

Updates data of only one specified line. (M0="H", M2="L")

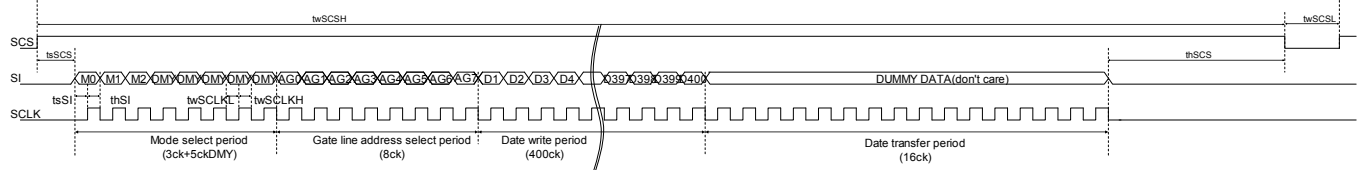

M0: Mode flag. Set for "H". Data update mode (Memory internal data update)
When "L", display mode (maintain memory internal data).

M1: Frame inversion flag.
When "H", outputs VCOM="H", and when "L", outputs VCOM="L".
When EXTMODE="H", it can be "H" or "L".

M2: All clear flag.
Refer to 6-5-4) All Clear Mode to execute clear.

DUMMY DATA: Dummy data. It can be "H" or "L" ("L" is recommended.)

※ Data write period
Data is being stored in 1st latch block of binary driver on panel.
※ Data transfer period
Data written in 1st latch is being transferred (written) to pixel internal memory circuit.

* For gate line address setting, refer to 6-6) Input Signal and Display.

* M1: Frame inversion fl is enabled when EXTMODE="L".

* When SCS becomes "L", M0 and M2 are cleared.

6-5-2 Data Update Mode (Multiple Lines)

Updates arbitrary multiple lines data. (M0="H", M2="L")

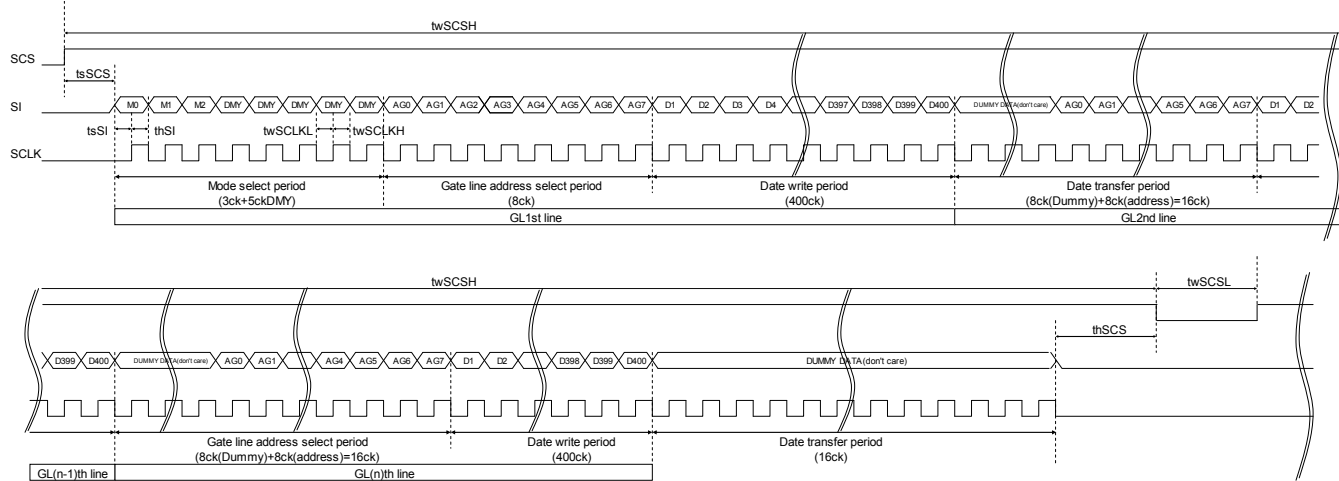

M0: Mode flag. Set for "H". Data update mode (Memory internal data update)
When "L", display mode (maintain memory internal data).

M1: Frame inversion flag.
When "H", outputs VCOM="H", and when "L", outputs VCOM="L".
When EXTMODE="H", it can be "H" or "L".

M2: All clear flag.
Refer to 6-5-4) All Clear Mode to execute clear.

DUMMY DATA: Dummy data. It can be "H" or "L" ("L" is recommended.)

- ※ Data write period
Data is being stored in 1st latch block of binary driver on panel.
- ※ Data transfer period
For example, during GL2nd line data transfer period, GL 2nd line address is latched and GL1st line data is transferred from 1st latch to pixel internal memory circuit at the same time.

* For gate line address setting, refer to 6-6) Input Signal and Display.

* Input data continuously.

* M1: Frame inversion flag is enabled when EXTMODE="L".

* When SCS becomes "L", M0 and M2 are cleared.

6-5-3 Display Mode

Maintains memory internal data (maintains current display). (M0="L", M2="L")

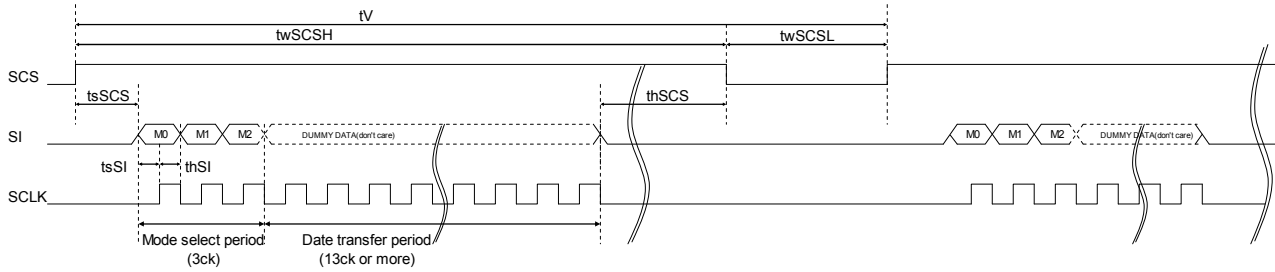

M0: Mode flag. Set for "H". Data update mode (Memory internal data update)
When "L", display mode (maintain memory internal data).

M1: Frame inversion flag.
When "H", outputs VCOM="H", and when "L", outputs VCOM="L".
When EXTMODE="H", it can be "H" or "L".

M2: All clear flag.
Refer to 6-5-4) All Clear Mode to execute clear.

DUMMY DATA: Dummy data. It can be "H" or "L" ("L" is recommended.)

* M1: Frame inversion flag is enabled when EXTMODE="L"

* When SCS becomes "L", M0 and M2 are cleared.

6-5-4 All Clear Mode

Clears memory internal data and writes white. (M0="L", M2="H")

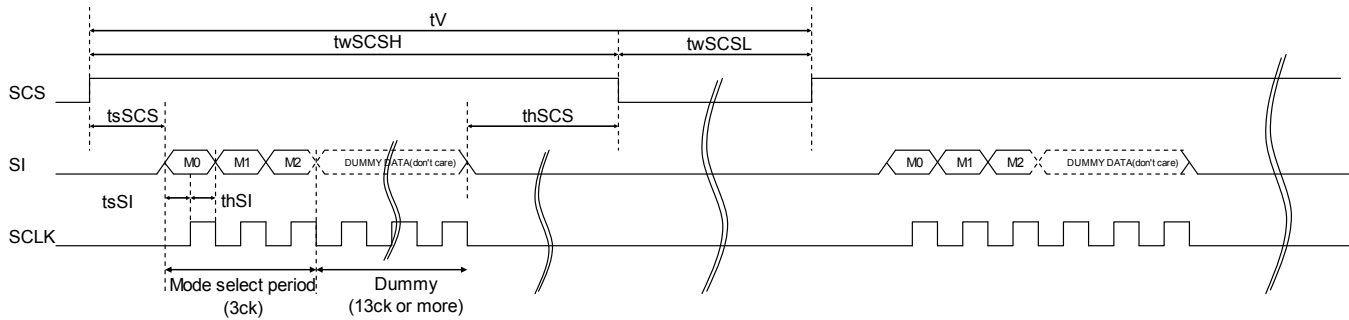

M0: Mode flag.

Set it "L".

M1: Frame inversion flag.

When "H", outputs VCOM="H", and when "L", outputs VCOM="L".

When EXTMODE="H", it can be "H" or "L".

M2: All clear flag.

Set it "H"

DUMMY DATA: Dummy data. It can be "H" or "L" ("L" is recommended.)

* M1: Frame inversion flag is enabled when EXTMODE="L".

* When SCS becomes "L", M0 and M2 are cleared.

6-5-5 COM Inversion

There are two types of inputs, COM signal serial input (EXTMODE="L") and external COM signal input (EXTMODE="H").

EXTMODE="L"

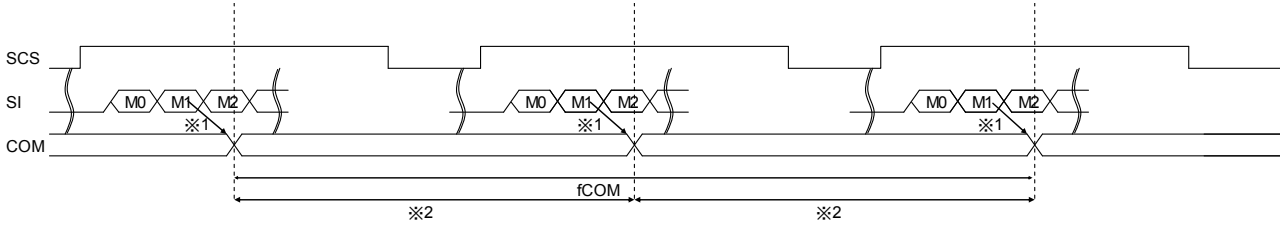

M1: LC polarity inversion flag: If M1 is "H" then VCOM="H" is output. If M1 is "L" then VCOM="L" is output.

* 1: LC inversion has been changed by M1 flag statement.

* 2: The periods of plus polarity and minus polarity should be same length as much as possible.

EXTMODE="H"

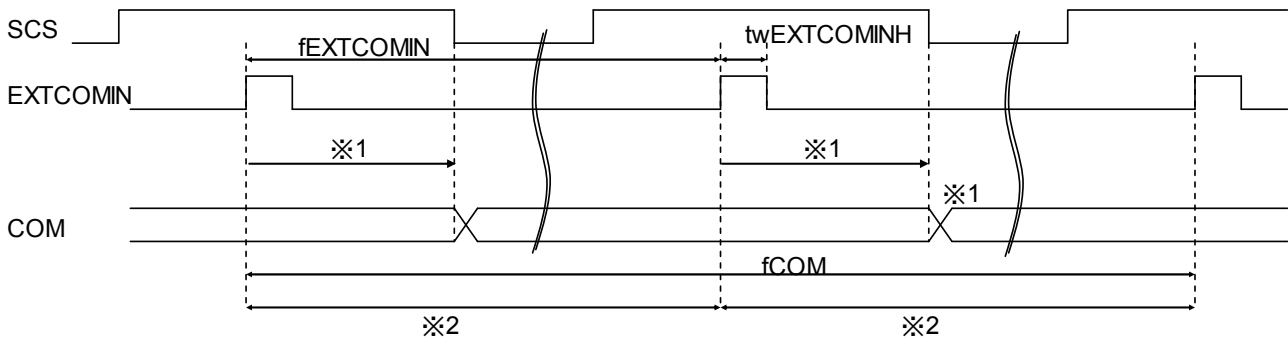

※1: LC inversion polarity has been set by the rising timing of EXTCOMIN in internal circuit block

※2: The period of EXTCOMIN should be constant.

② EXTCOMIN input when the SCS signals is low.

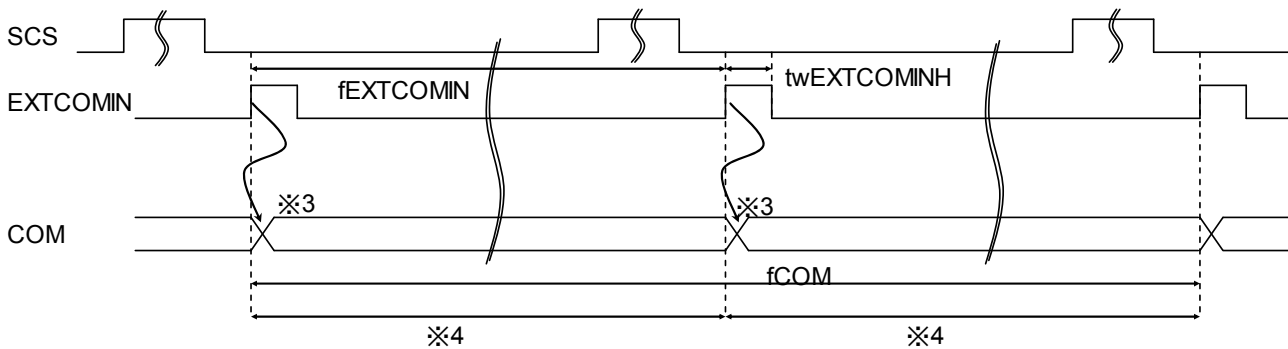

※3: LC inversion polarity has been set by the rising edge of EXTCOMIN.

※4: The period of EXTCOMIN should be constant.

6-6) Input Signal and Screen Display, Gate Address (Line) Setup

Data screen display position[H,V]

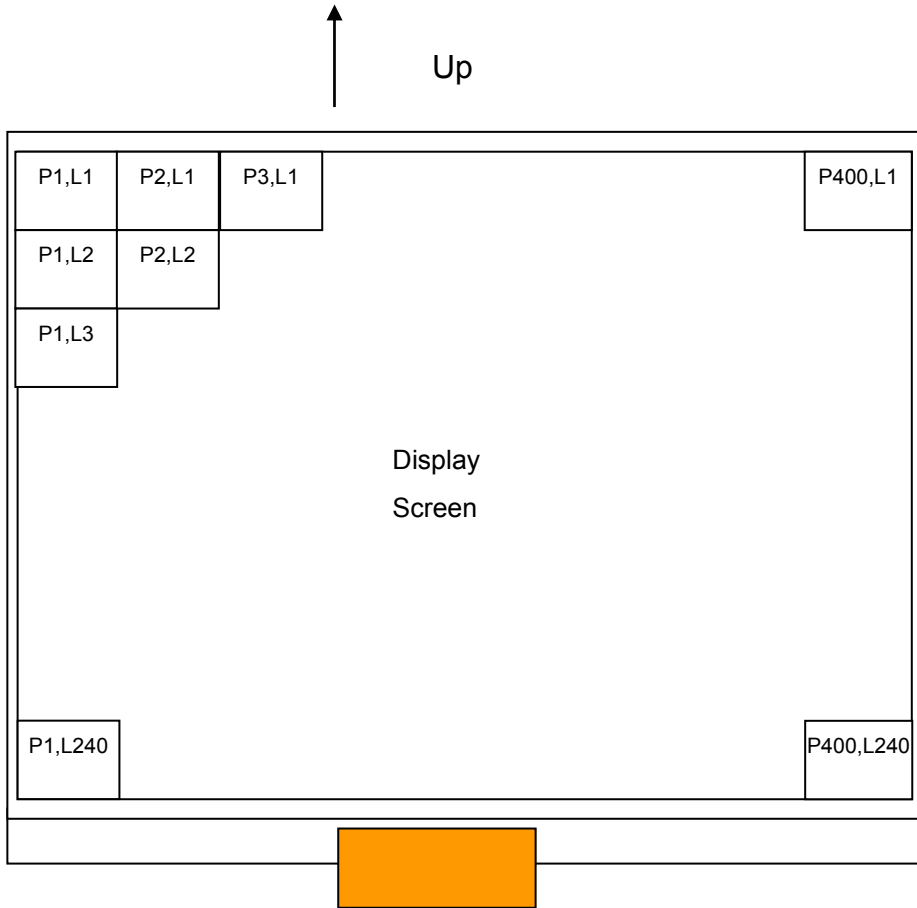

Line	Gate Line Address Setup							
	AG0	AG1	AG2	AG3	AG4	AG5	AG6	AG7
L1	H	L	L	L	L	L	L	L
L2	L	H	L	L	L	L	L	L
L3	H	H	L	L	L	L	L	L
.
.
.
L238	L	H	H	H	L	H	H	H
L239	H	H	H	H	L	H	H	H
L240	L	L	L	L	H	H	H	H

7. Optical Characteristics

Table 7-1

Ta=25°C

Item	Code	MIN.	TYP.	MAX.	Unit	Remark
Viewing Angle CR \geq 2	H	$\theta_{21, \theta_{22}}$	40	55	°(Degree)	【Remark 7-1】
	V	θ_{11}	40	60	°(Degree)	
		θ_{12}	40	60	°(Degree)	
Contrast Ratio	CR.		14			【Remark 7-2, 3】
Reflection Ratio	R		17.5		%	【Remark 7-3】
Transmission Ratio	T		0.25		%	【Remark 7-5】
Response Speed	Rise	τ_r	10	20	ms	【Remark 7-3,4】
	Fall	τ_d	20	40	ms	
Panel Surface Chromaticity	White	x		0.305		【Remark 7-3】
		y		0.330		

【Remark 7-3】 Optical Characteristics Measurement Equipment

Contrast ratio, reflective ratio and panel surface chromaticity are measured as shown in figure 7-2, and Response speed is measured as shown in Figure 7-3. Both measurement methods are done in dark Room or equivalent.

Measurement Equipment (CM-2002)

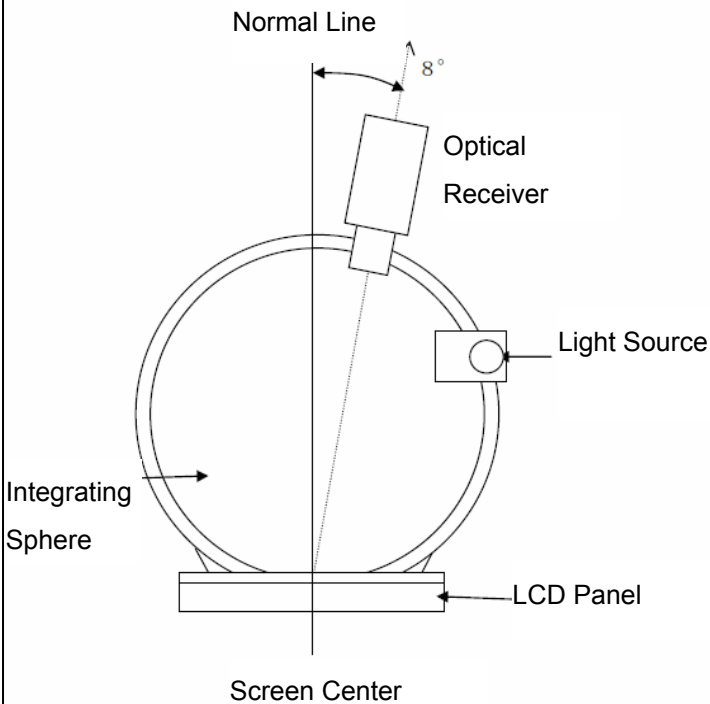

Measurement Equipment (LCD-5200)

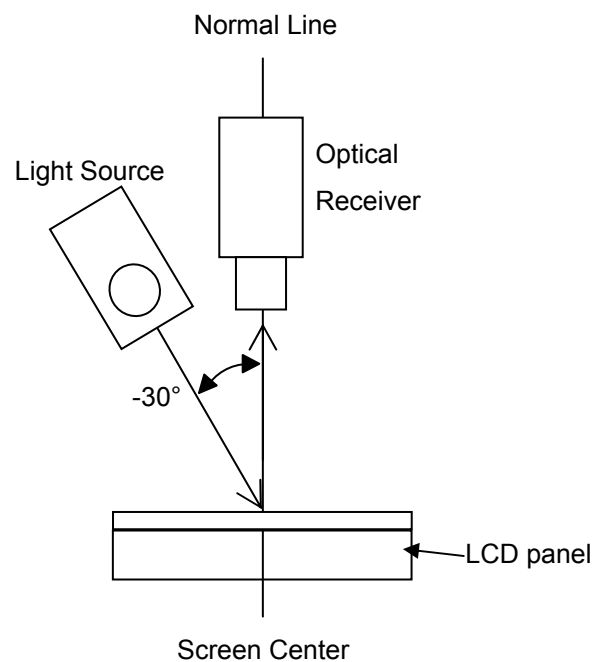
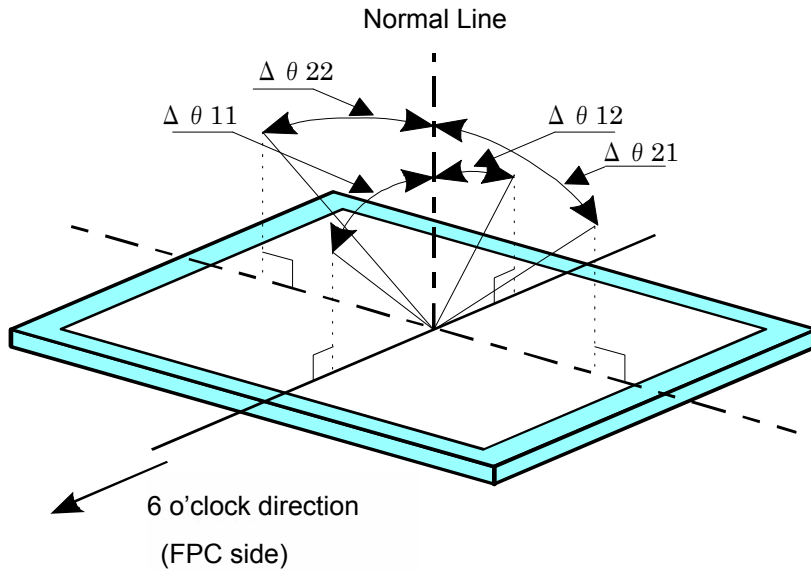

Figure 7-2 Measurement of contrast, reflective ratio and panel surface chromaticity

【Remark 7-1】Definition of Viewing Angle



【Remark 7-2】 Definition of Contrast Ratio

Defined as shown in below formula

$$\text{Contrast Ratio (CR)} = \frac{\text{Reflection intensity of white display}}{\text{Reflection intensity of black display}}$$

【Remark 7-4】Definition of Response Speed (Reflection Ratio Change)

Input signal for white and black as shown below and define by the change in time it takes for optical receiver output.

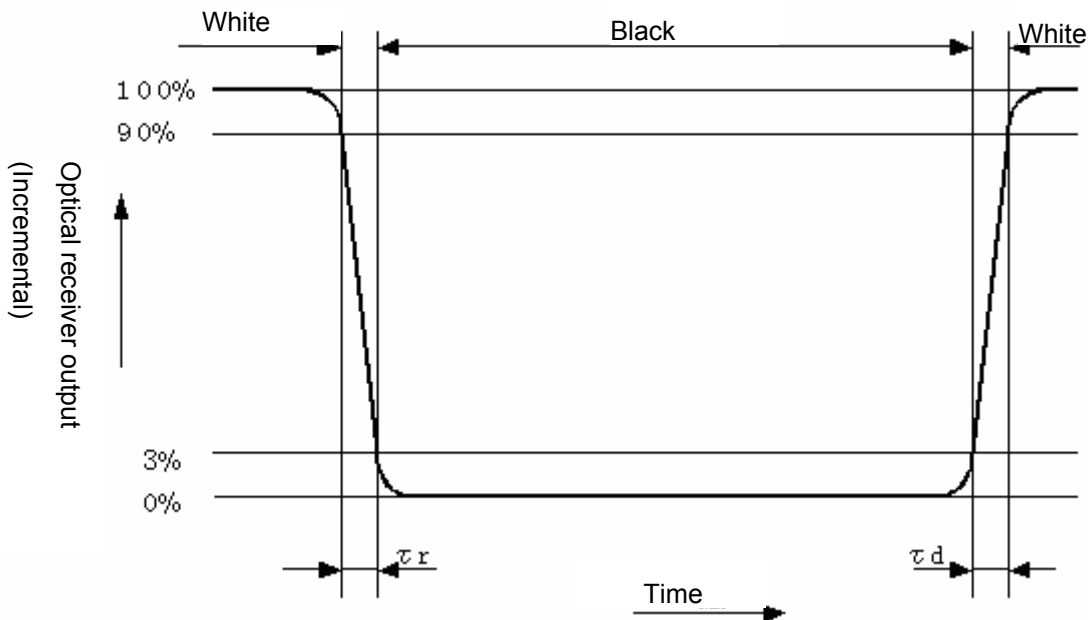

Figure 7-3 Measurement of response speed

【Remark 7-5】 Panel luminance calculation.

Backlight can be implemented underneath the panel, display can be shown with the luminance which is depended on the Backlight luminance. The luminance can be calculated by “the panel transmissivity (0.25%)” multiply “Backlight luminance”.

8. Outline Dimension

Figure 8-1 2.7" WQVGA Monochrome Outline Dimension

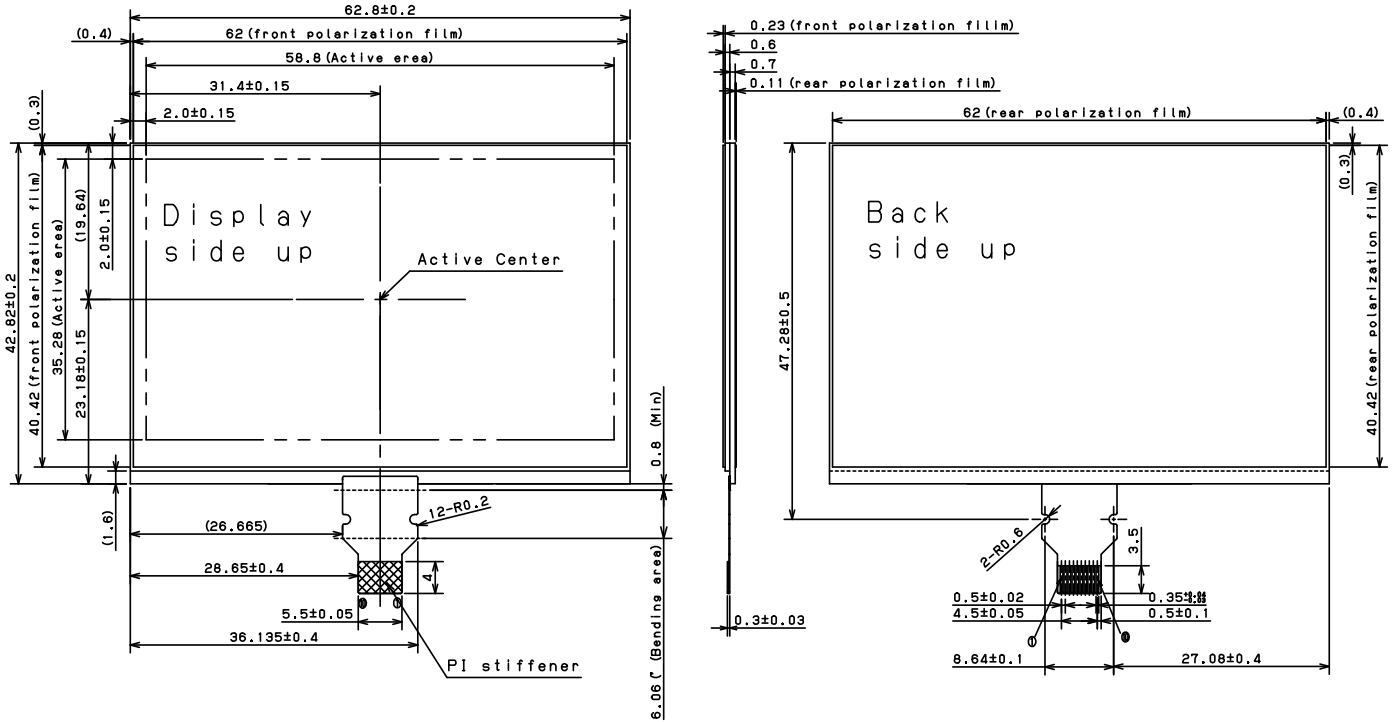

<Recommended Connector> SMK FP12 Series: CFP-4610-0150F(Bottom side contact)
Molex: 51441-1093(Bottom side contact)

8-2) FPC Bend Specification

When bending FPC, bend where specified in Condition (1) and the bend R should be more than R specified in Condition (2). FPC is not to contact glass edge, and there should be no stress to connective area between panel and FPC.

Condition (1) FPC bend recommended area: 0.8mm – 6.0mm from glass edge.

Condition (2) Minimum bend R: Inner diameter R0.45

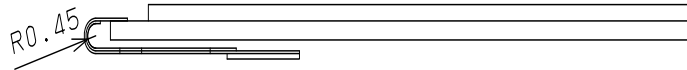

Figure 8-2

【Remark 8-1】 Do not bend backward (toward polarizer film side)

【Remark 8-2】 Bend frequency: 3 times or less (Repeat bend condition: 180° ~ 0°)

<Recommended Connector> SMK FP12 series : CFP-4510-0150F (Top side contact)

9. External Circuit Example

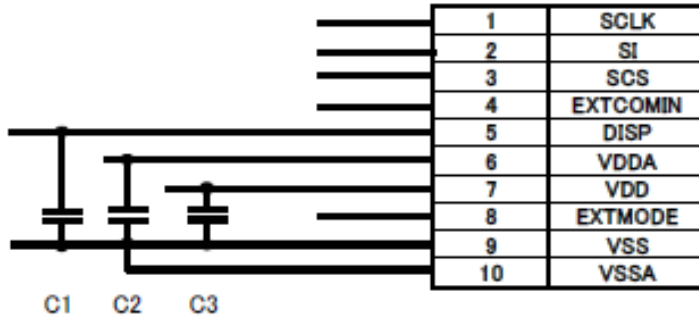

Figure 9-1 External Circuit (Recommended)

<Recommended Capacitor>

- C1: Between DISP-VSS, B characteristics 0.1uF ceramic capacitor
- C2: Between VDDA-VSS, B characteristics 0.1uF or more cerac capacitor
- C3: Between VDD-VSS, B characteristics 1uF or more ceramic capacitor

※Above circuit and parts are only recommendation.

For actual use, please evaluate their conformity with your system and design.
(Capacitor pressure resistance can be larger than resistance indicated above.)

10. External Power Supply Circuit

An external power supply circuit is necessary to drive the memory LCD with 3V battery.
Table 10-1 shows recommended power supply IC>

Table 10-1

Vendor	Model No.	Note
SII	S-8821	Charge pump type
National Semiconductor	LM2750	Charge pump type

【Remark 10-1】For detailed specification, refer to specification for each power supply IC.

【Remark 10-2】To use, set constant value after sufficient evaluation of actual application.

Electrical Characteristics

Table 10-2

Model No.	Vin [V]		Vout			Iout [A]
	min	max	min	typ	max	
S-8821	2.8	5.0	4.9	5.0	5.1	0.04
LM2750	2.7	5.6	4.8	5.0	5.2	0.04

【Remark 10-3】For detailed specification, refer to specification for each power supply IC.

【Remark 10-4】To use, set constant value after sufficient evaluation of actual application.

Reference Circuit

Reference circuit is shown below.

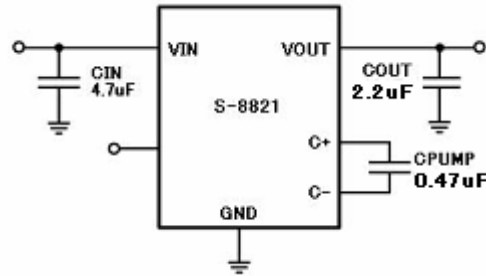

S-8821

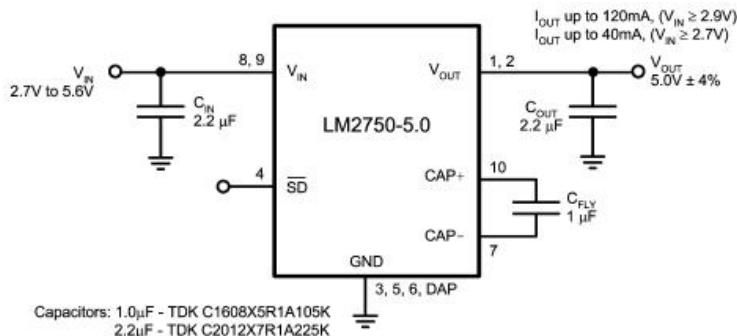

Capacitors: 1.0µF - TDK C1608X5R1A105K
2.2µF - TDK C2012X7R1A225K

LM2750

11. Packaging

11-1) Lot number

Will be indicated on serial number label as indicated in Figure 11-1 outline dimension figure.

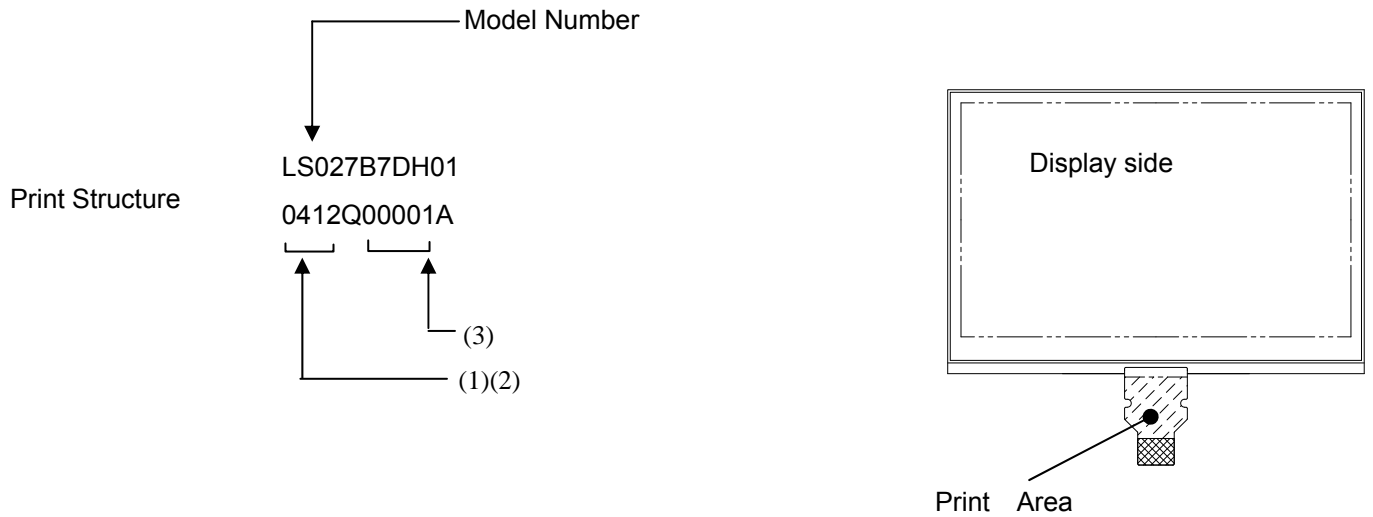

Serial number specification

- (1) Last digit of the year
- (2) Month and date of manufacture
- (3) 5 digit consecutive numbers

Figure 11-1 Serial number print location

11-2) Package Storing

(1) Maximum number of carton in a stack: 12 cartons

Maximum quantity of units in carton: 400 units per carton

(2) Storage condition

- Temperature: 0 ~ 40°C
- Humidity: 60%RH or lower (at 40°C)

There should be no condensation at low temperature and high humidity.

- Atmosphere: No harmful gas, such as acid or alkali, which causes severe corrosion on electronic parts and wiring, are to be detected.
- Period: About 3 months
- Opening the package: in order to prevent electrostatic damage to TFT modules, room humidity should be made over 50%RH and take effective measure such as use of earth when opening the package.

11-3) Packaging

Packaging condition is shown in Figure 11-2.

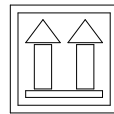
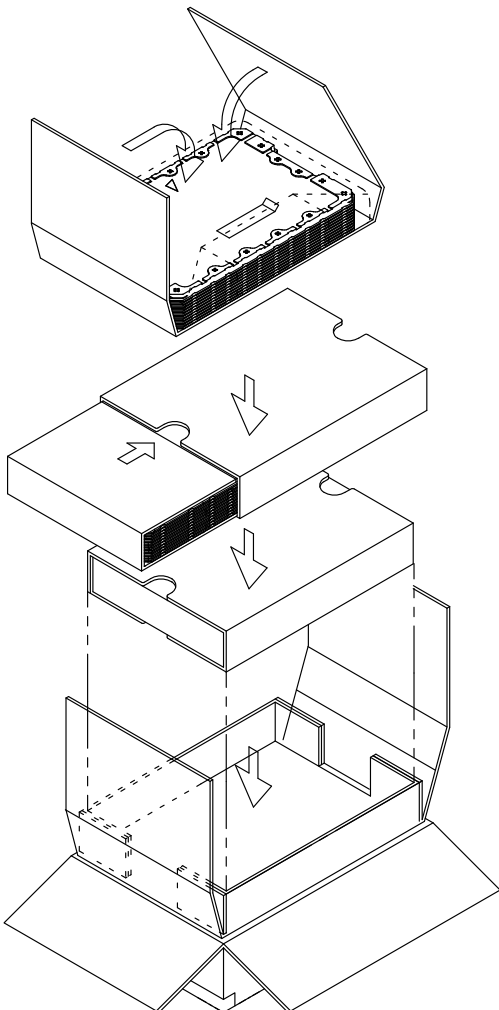

FRAGILE
取扱注意

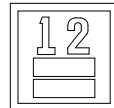

SHARP®
Electronic Components

TYPE		社内品番: (4S) LS027B7DH01
QUANTITY		LotNO. : (1T) 2010. xx. xx
LOT (DATE)		Quantity: (Q) 400 PCS
		ユーザー品番 : _____
		シャープ物流用ラベルです。 () ()

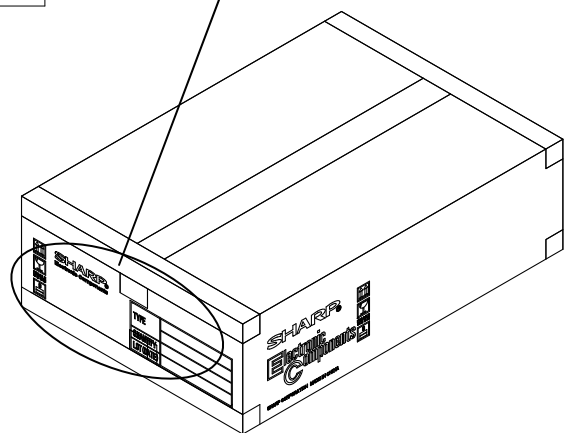

Packageing size : 578mmx382mmx153mm

Figure 11-2 Packaging Condition

12. Reliability Test Conditions

12-1) Reliability test items

Table 12-1 Reliability test items

	Test items	Test condition	Remark
1	High temperature storage	Ta=80°C 240h (Non-operating)	
2	Low temperature storage	Ta=-30°C 240h (Non-operating)	
3	High temperature/humidity operation	Tp=40°C/95%RH 240h	
4	High temperature operation	Tp=70°C 240h	
5	Low temperature operation	Tp=-20°C 240h	
6	Heat shock	Ta=-30°C(1h)~+80°C(1h)/cycle=5cycle (Non-operating)	
7	Electrostatic discharge	±200V、200pF(0Ω) 1 time/each terminal	

【Note】 Ta=Surrounding temperature, Tp=Panel temperature

(Evaluation method)

In standard condition, there shall be no practical problems that may affect the display function.

12-2) Panel surface stress specification

“Force of stress [N]” without display failure (display non-uniformity) is defined as follow:

Load testing (minimum): 120[N] or higher

Test conditions)	Module:	LCD panel
	Load point:	LCD panel center (glass cloth tape applied in load point area)
	Press jig:	φ 10mm cylinder
	Press speed:	1mm/minute
	Support:	Secured on stage
	Press time:	Hold for 5 seconds after reaching test press load and then release